

# TECHNICAL GUIDE

CAL. 0680A  
**DIGITAL QUARTZ**

## CONTENTS

I. SPECIFICATIONS .....	1
1. Specifications .....	1
II. AFTER-SERVICING INSTRUMENTS AND MATERIALS.....	2
1. After-servicing instruments and materials .....	2
2. How to use after-servicing instruments and materials for repair.....	3
III. DISASSEMBLING AND REASSEMBLING .....	5
1. Disassembling and reassembling of case .....	5
2. Disassembling and reassembling of movement and lubricating of switch components .....	6
3. Cleaning.....	10
IV. CHECKING AND ADJUSTMENT .....	11
1. Guide for checking and adjustment .....	11
2. Explanation of malfunction .....	12
3. Segment and MOS-IC output terminal .....	13
4. Checking and adjustment .....	14
A. Check battery voltage .....	14
B. Check contact of MOS-IC and liquid crystal panel .....	14
C. Check liquid crystal panel and circuit block.....	15
D. Check current consumption .....	15
E. Check accuracy .....	15
F. Time accuracy adjusting .....	16
G. Check time and date setting conditions .....	17
H. Check setting mechanism .....	17
I. Check bulb .....	17
V. PACKING AND MAINTENANCE OF THE SPARE PARTS .....	18

# I. SPECIFICATIONS

## 1. Specifications

Item	Calibre	0680A
Display system		Hour, Minute: 12-hour Digital Display System showing hour and minute Second: The dots blink once every second Date, AM and PM display
Display medium		Single Crystal Display (Nematic Liquid Crystal, FE (field effect)-type)
Operation		<b>Front buttons</b> * Instant adjusting device of date, hour and minute by selection and setting system (can be adjusted separately) * Instant second setting device * Illumination light <b>Side button</b> * Lock switch
Crystal oscillator		32,768 Hz. (Hz. = Hertz . . . cycles per second)
Loss/gain		Loss/gain at normal temperature range Mean monthly rate: less than 20 seconds (Annual rate: less than 4 minutes)
Casing diameter		φ27.0 mm
Height		8.5 mm
Operational temperature range		-10°C ~ +60°C (14°F ~ 140°F)
Regulation system		Trimmer condenser
Battery power		Silver oxide battery (U.C.C. 386) Battery life is over one year
IC (integrated circuit)		C-MOS-LSI . . . 1 pce. Hybrid-IC . . . 1 pce.

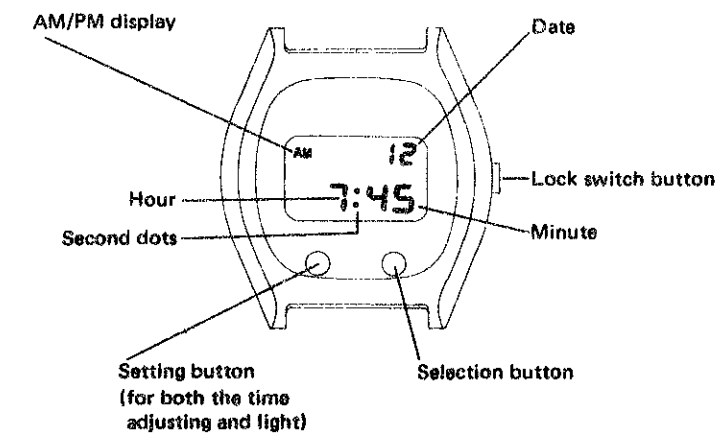

## II. AFTER-SERVICING INSTRUMENTS AND MATERIALS

### 1. After-servicing instruments and materials

For after-servicing of Digital Quartz Cal. 0680A, the following after-servicing instruments and materials are necessary.

#### (1) Quartz Tester (QT-10)

Used to check time accuracy (daily rate).

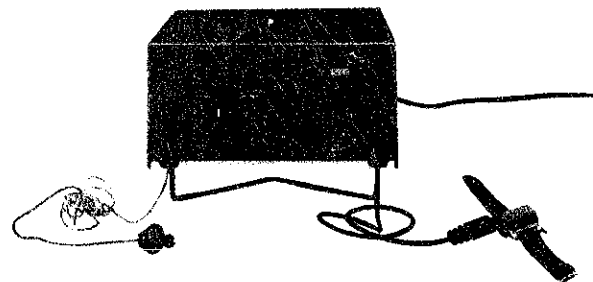

#### (2) Tester

Used to check battery voltage and measure current consumption.

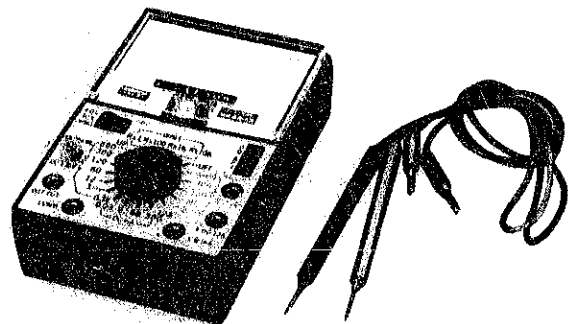

#### (3) Movement holder

Used for disassembling and reassembling of the movement.

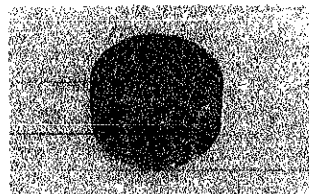

#### (4) Battery holding spring

Used for securing battery and flowing current when the movement is removed from the case.

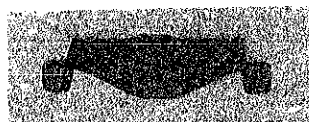

## 2. How to use the after-servicing instruments and materials for repair

### (1) How to use Quartz Tester (QT-10)

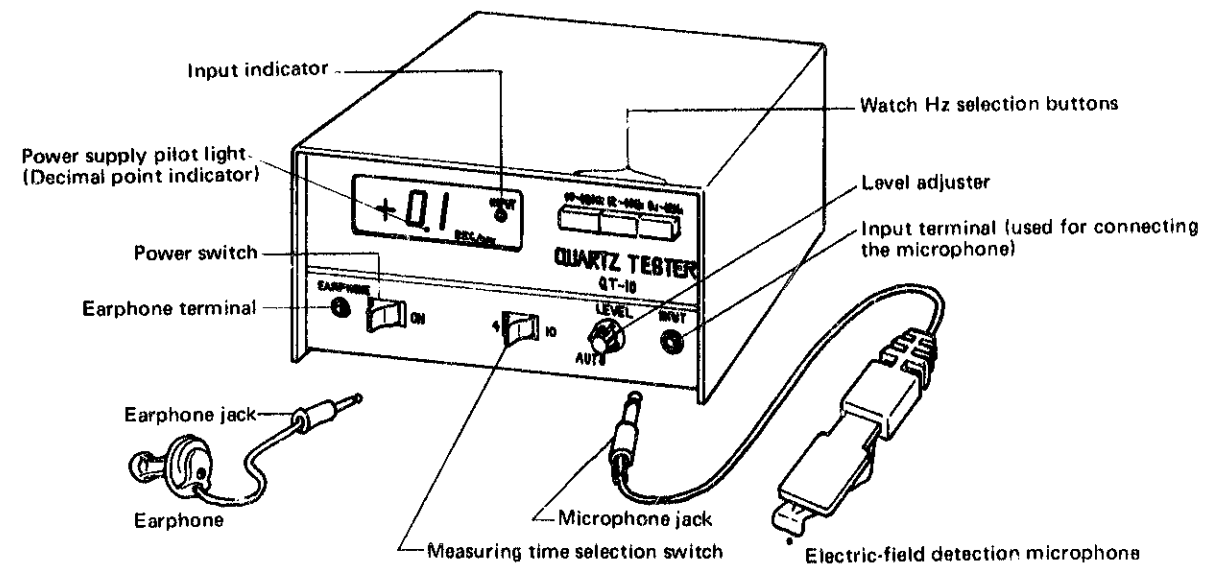

#### [Measuring time accuracy (daily rate)]

1. Insert the power supply cord plug into a power outlet.
2. Turn on the power switch. Make sure that the power supply pilot light is lit.
3. Attaching the microphone  
Insert the microphone jack into the input terminal.
4. Push the watch Hz selection button (White button, 12 ~ 40 Hz).

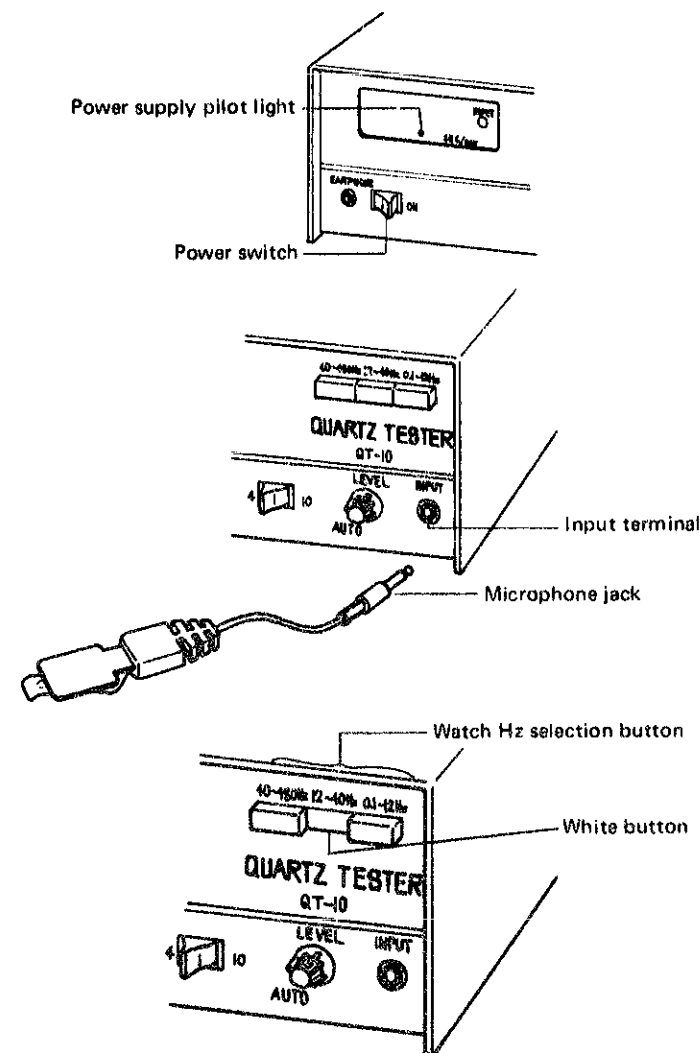

5. Turn the measuring time selection switch to the "4" or "10" position. As regards the Cal. 0680A, measurement is possible in either position.

6. Insert the earphone jack into the earphone terminal of the Quartz Tester.

7. Clip the microphone to the watch

- In order that the microphone's flat surface may be in contact with the panel side of the watch, put the watch between the clip of the microphone from the opposite side of the lock switch button of the watch. That is, nearest the hour digit. This is because the microphone selects the electric field of the liquid crystal panel. It may be impossible to measure time when the digits on the panel display change. The hour digit portion does not change quickly. Put conductive rubber sheet between the microphone and the case back to prevent the watch from being scratched.

- Put on the earphone and move the microphone slightly. Hold the watch and microphone firmly between the fingers to insure a good contact. The input indication light will be continuously lit if this procedure is followed. While the level adjuster is in the AUTO position, measurement is feasible, but whenever the input indication light blinks or goes off, adjust it by turning the level adjuster so that the indication light is continuously lit.

8. The daily rate is readable on the indication section.

- When the daily rate is excessive, there will be no indication.

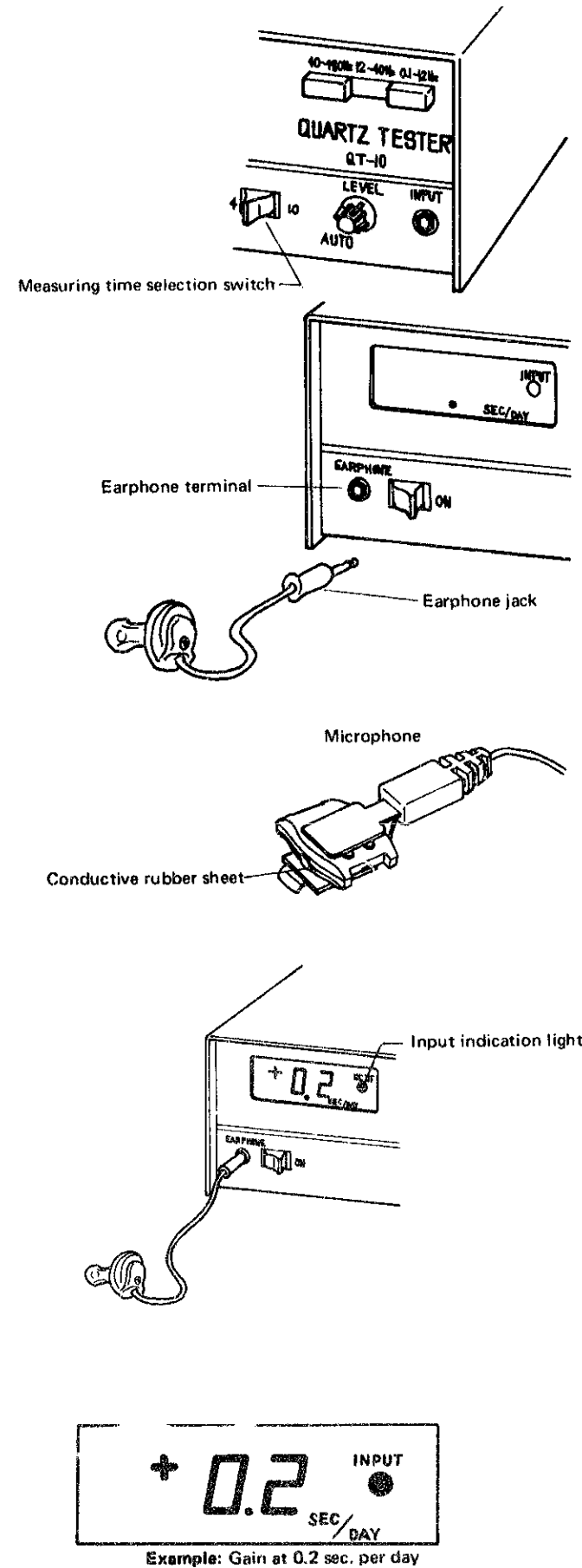

### III. DISASSEMBLING AND REASSEMBLING

#### 1. Disassembling and reassembling of case

##### (1) Structure of case

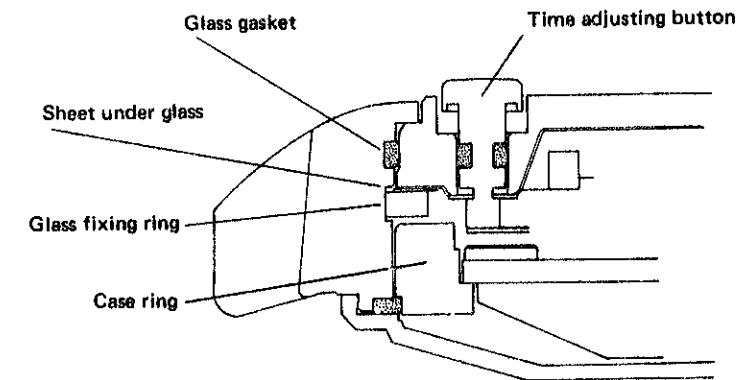

##### (2) Remarks for disassembling of case

- **Glass fixing ring**
  - When removing the glass fixing ring, insert the tweezers to the notch and remove the ring by bending it inward.
  - Be careful not to scratch inside surface of the glass by tweezers where instruction is printed.
- **Glass**
  - Give a push by finger and remove the glass.

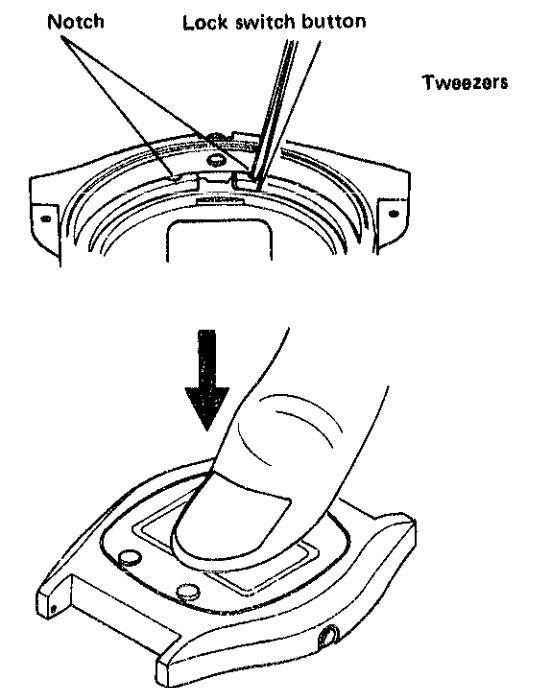

##### (3) Remarks for reassembling of case

- **Sheet under glass**
  - Assemble the sheet under glass like figure right (Fix the notch to the lock button).
- **When reassembling the movement**
  - Pull out the setting lever and set the movement to the case.
  - Be sure to check the setting lever and lock switch button are properly connected.
  - When casing, check the movement is set at the correct position by adjusting the display and the mask.

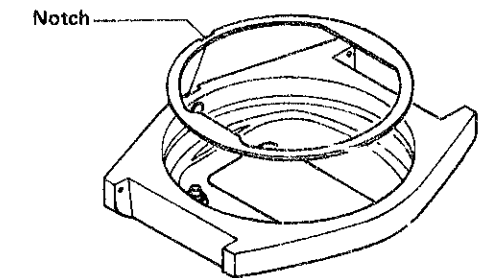

## 2. Disassembling and Reassembling of the movement and lubricating of the switch components

### (1) Procedures

Disassembling procedures Figs.: ① ~ ⑪  
 Reassembling procedures Figs.: ⑪ ~ ①  
 Lubricating  : Watch Oil, S-6,  
 normal quantity

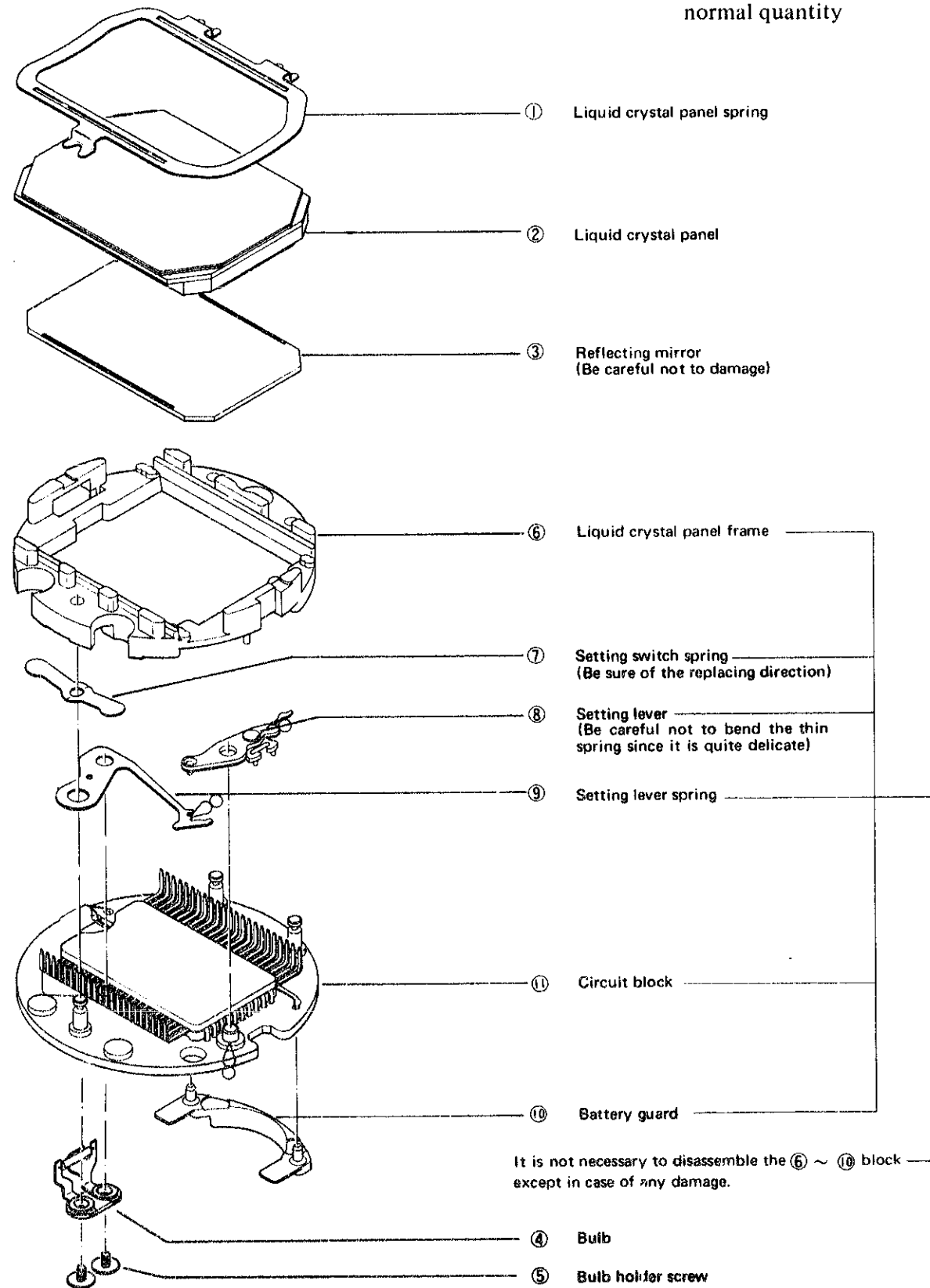

### (2) Remarks for disassembling and reassembling of movement

#### • Disassembling

Disassembling of the liquid crystal panel spring.

#### • Disassembling procedures

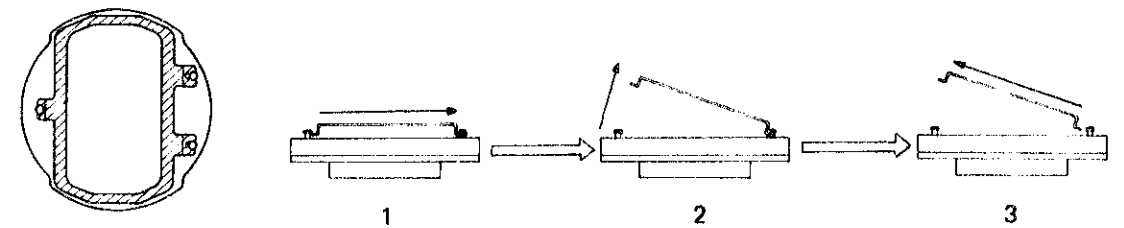

Liquid crystal panel

- Use fingercods to disassemble and reassemble the liquid crystal panel.

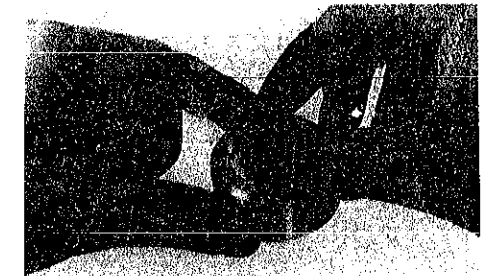

Liquid crystal panel frame

(Not necessary to remove it unless damaged.)

- In order to remove the liquid crystal panel frame, insert a pair of tweezers into the side of the guide pins (3 pcs.) for the liquid crystal panel frame, and gradually raise the frame as shown in the photo.

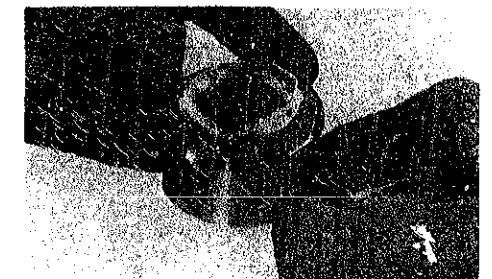

Setting lever (Not necessary to remove it unless damaged.)

- Don't pick up the thin spring with tweezers.

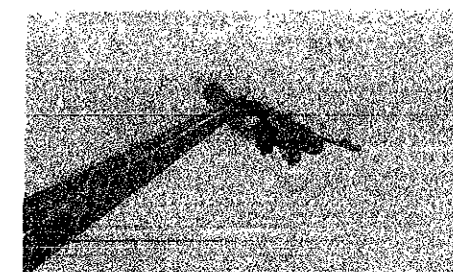

Correct

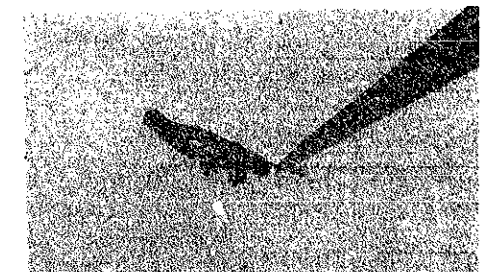

Incorrect

• **Reassembling**

Setting switch spring

- Make sure to assemble it in the correct direction.

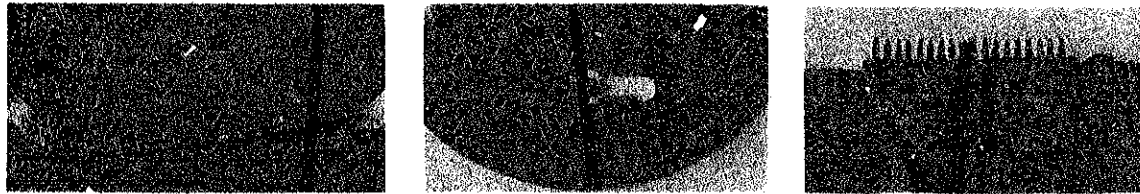

Liquid crystal panel frame

- Hold it horizontally and push in gradually.

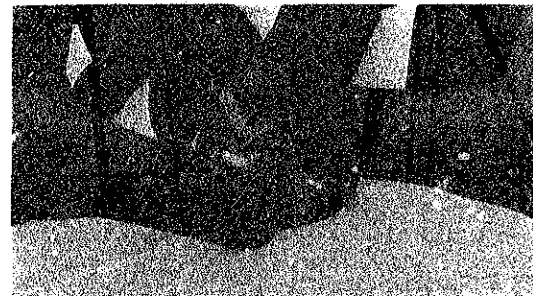

- Be careful not to bend the MOS IC terminal by pushing on the liquid crystal panel frame.

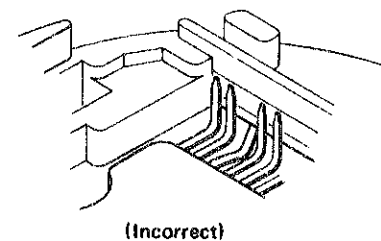
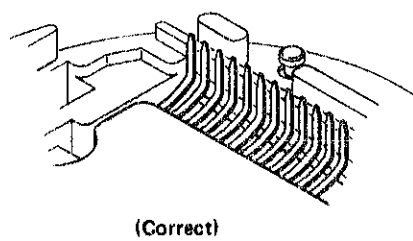

Reflecting mirror

- Assemble the reflecting mirror with the mirror side down.
- Place it correctly on the liquid crystal panel frame.

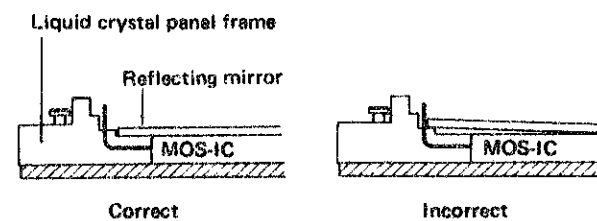

Liquid crystal panel

- Before reassembling the liquid crystal panel, check the height of contacts of MOS IC terminals. If there are terminals found to be too low, raise them with tweezers.

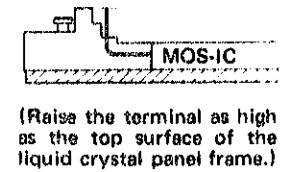
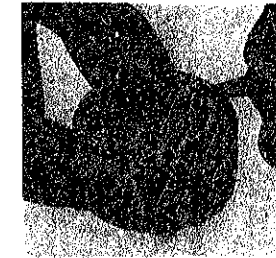

- Wipe off dust and lint with a brush from the MOS IC terminals and electrode of the liquid crystal panel.
- Reassemble the MOS IC terminals horizontally so as not to bend it.



Liquid crystal panel spring

- Reassembling

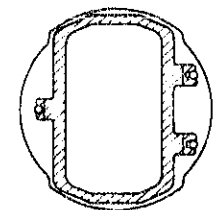
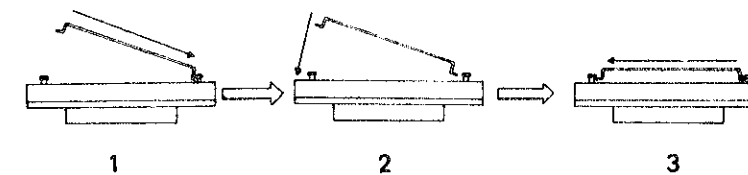

Be careful not to damage the edge of the liquid crystal panel with the liquid crystal panel spring.

- When the liquid crystal panel spring has been reassembled, insert the battery and make sure that all segments are lit. If there is any segment which is left unlighted, refer to

**B** Check contact of MOS-IC and Liquid crystal panel

of "Checking and Adjustment" on page 13 for repair.

3. Remarks for battery replacement

Incomplete digital figures may be indicated on the display panel after battery replacement. However, this is not a malfunction, the digital figures should be corrected according to the following procedures:



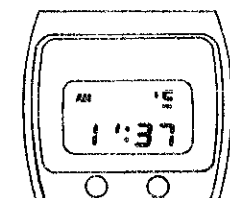



Try to depress the adjusting button to correct all digital figures.

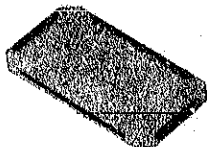
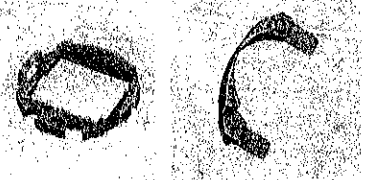

### 3. Cleaning

Since several parts of 0680A differ from conventional mechanical watches, use the following method when cleaning.

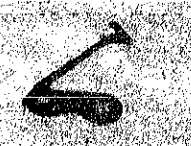
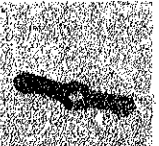
#### HOW TO CLEAN

Name of part	Cleaning	Drying	Solution	Remarks
(1) Liquid crystal panel 	DO NOT CLEAN			Wipe the electrode with a cloth moistened with benzine. The other parts should be cleaned with a soft dry brush only.
(2) Circuit block 	DO NOT CLEAN			Wipe dust and lint off the MOS-IC contacts with a soft dry bursh. For other contacts, use a cloth moistened with benzine.
(3) Reflecting mirror 	DO NOT CLEAN			Wipe the reflecting mirror with a soft brush or cloth moistened with alcohol if contaminated. Be careful not to scratch.
(4) Plastic parts Liquid crystal panel frame Battery guard 	Wash with a soft dry brush	Cool air	Alcohol, Benzine	
(6) Bulb 	Rinse	Cool air	Alcohol, Benzine	Refrain from using an ultra-sonic cleaner
(5) Parts other than above liquid crystal panel spring  Setting lever spring  Setting switch spring  Setting lever  Bulb holder screw 	Wash with a soft dry brush	Cool or hot air drying	Benzine, trichloroethylene	When cleaning the setting lever, be careful not to damage the thin spring.

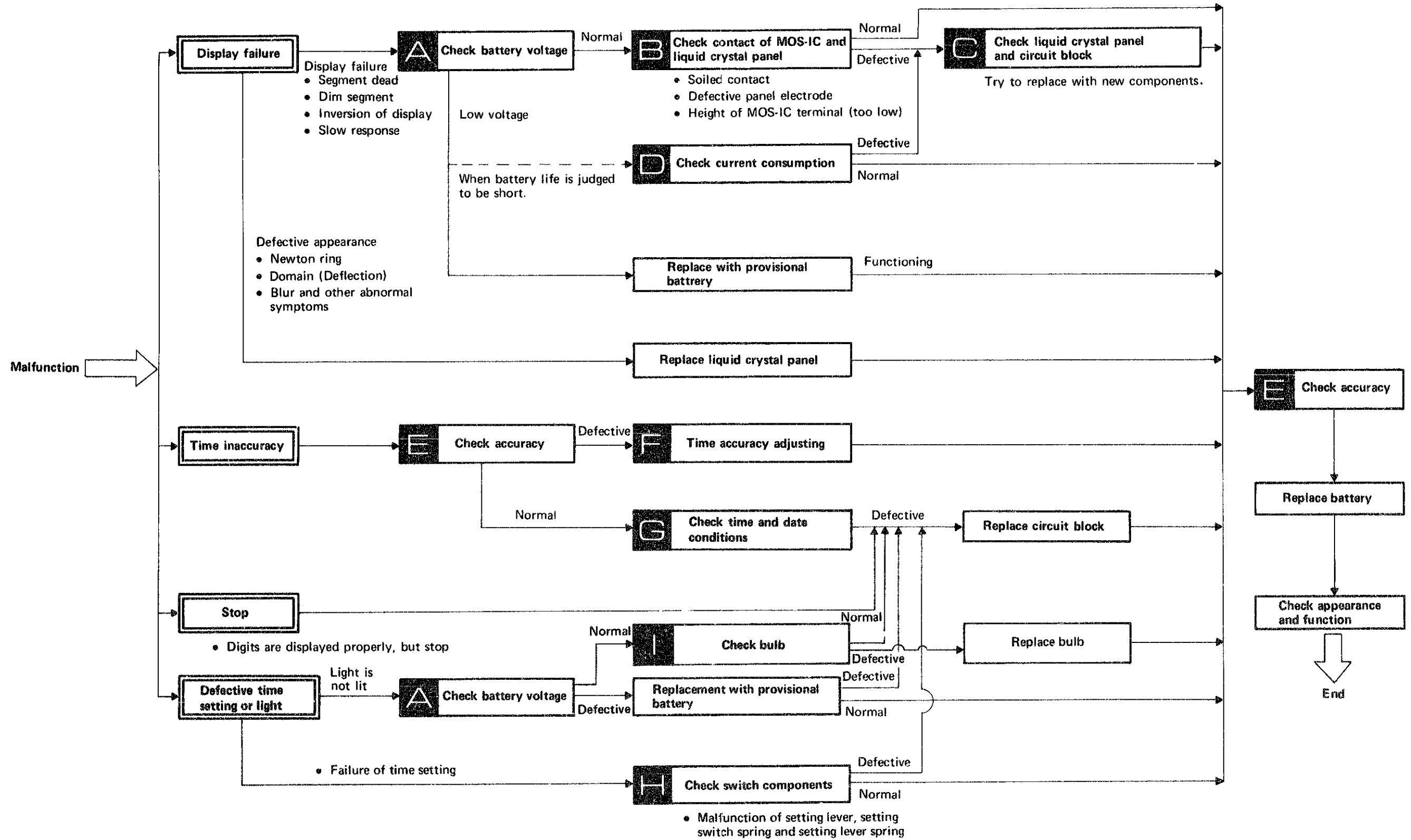

#### IV. CHECKING AND ADJUSTMENT

##### 1. Guide for checking and adjustment



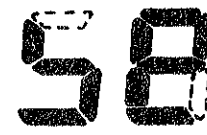
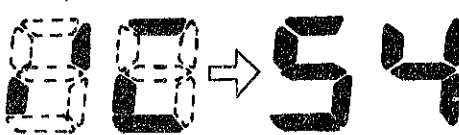

## 2. Explanation of malfunction

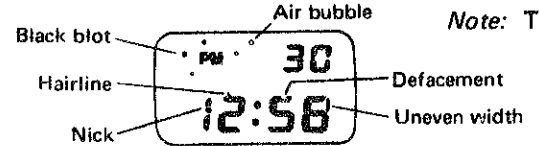
Symptom	Explanation
Segment dead	<ul style="list-style-type: none"> <li>The segments which are to be lighted are partially lit or not lighted at all. (They may sometimes light depending on button operation.)</li> </ul> <p><i>Example:</i> </p>
Inversion of display	<ul style="list-style-type: none"> <li>The segments which are to be lighted are turned off, while the segments which should not be lighted are turned on.</li> </ul> <p><i>Cause:</i> Common terminal is not connected to MOS-IC terminal.</p> <p><i>Example:</i> </p>
Slow response	<ul style="list-style-type: none"> <li>On/off operation of segments (to be checked by minute, hour or date setting) is slow.</li> </ul> <p><i>Remarks:</i> The response of the liquid crystal panel becomes slow when it is below 0°C but it becomes normal under normal temperatures.</p>
Newton ring	<ul style="list-style-type: none"> <li>The liquid crystal panel turns iridescent.</li> </ul> 
Deflection	<ul style="list-style-type: none"> <li>Some or all of segments show different contrast depending on the direction of view.</li> </ul> <p><i>Example:</i> </p>
Poor appearance of display	<p><i>Note:</i> The reflecting mirror is stained.</p> 
Time inaccuracy	<p>Though the Quartz Tester indicates the normal digit, a watch gains or losses excessively.</p> <ul style="list-style-type: none"> <li>The circuit block is usually suspected to be faulty. However, check the following before replacing the circuit block.             <ol style="list-style-type: none"> <li>Setting conditions of date, hour and minute:                 <ul style="list-style-type: none"> <li>Date: For more than 31 days;</li> <li>Hour: For more than 12 hours;</li> <li>Minute: For more than 60 min.</li> </ul> </li> </ol> </li> </ul>
Light will not turn up or dim.	<p>The light is not lit by pushing the light button while the normal time digits are displayed.</p> <p><i>Remarks:</i> On rare occasions the light will not go on and the digital display goes out while the light button is kept depressed.</p>

### 3. Segment (Electrode of Liquid Crystal Panel) and MOS-IC output terminal

A complete knowledge of how the segment (Electrode of Liquid Crystal Panel) works with the MOS-IC Output Terminal will provide the proper procedures for checking and adjusting.

#### 1. Segment

- Identification of digits

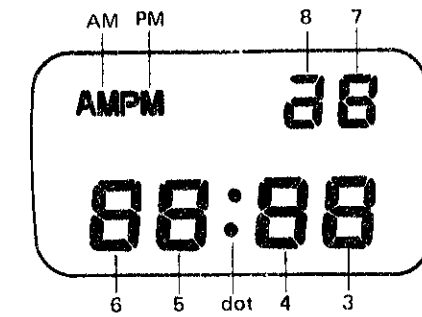

- Identification of segments  
One digit consists of seven (7) segments.

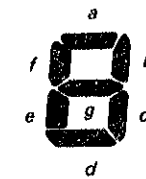

*Example:*  
The segment in mark ○ is called "4d".

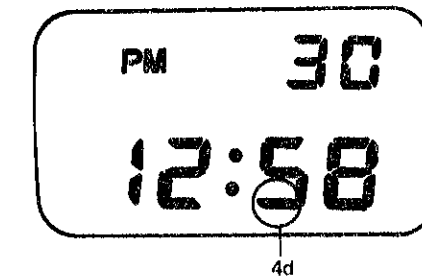

#### 2. Connection with MOS-IC output terminal

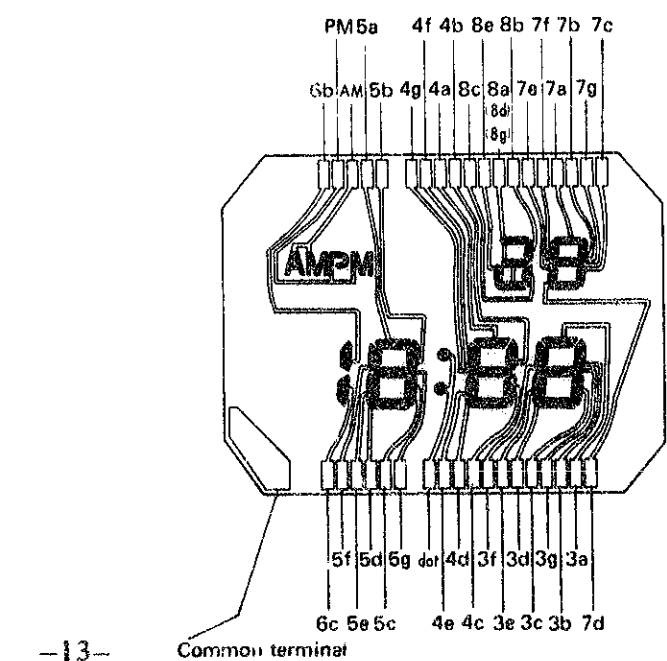
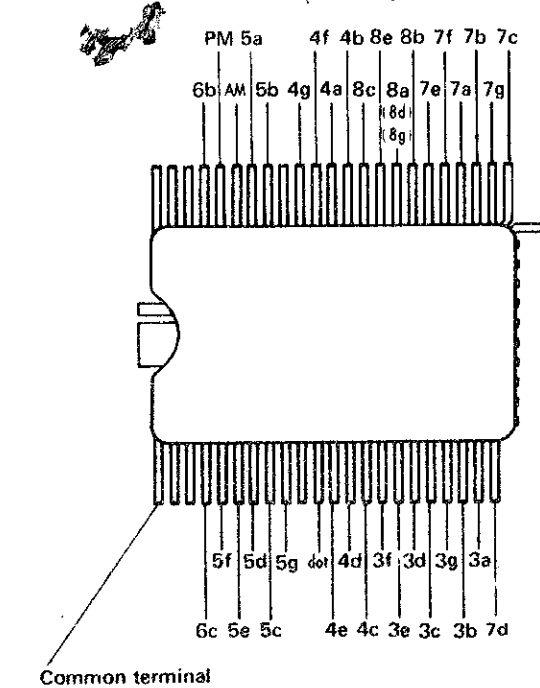

#### 4. Checking and adjustment

##### A Check battery voltage

Use the following procedures to check battery voltage.

- (1) **Set up the tester**  
Range to be used: DC 3 V

(2) **Measuring**

- Probe Red (+) ..... Battery surface (+)
- Probe Black (-) ..... Battery surface (-)

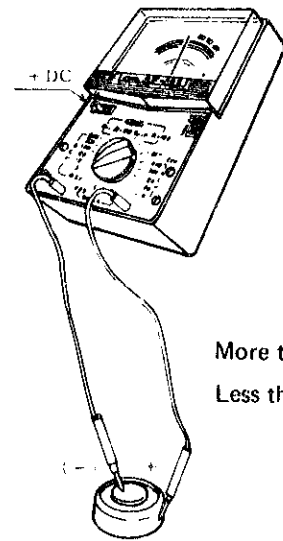

More than 1.5 V ... Normal  
Less than 1.5 V ... Defective

##### B Check contact of MOS-IC and liquid crystal panel

Set up the battery with the battery holding spring before checking.

**Remarks:** Do make sure to check the terms of (1) and (2) in "Remarks for battery replacement" on page 9.

After removing the liquid crystal panel, check the conductivity of the electrode of liquid crystal panel and MOS-IC output terminals. (See page 13 for "Segment and MOS-IC output terminal.")

- (1) **Check to see if there is any contamination on the liquid crystal panel electrodes and the MOS-IC output terminal.**

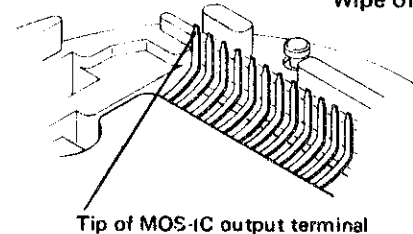
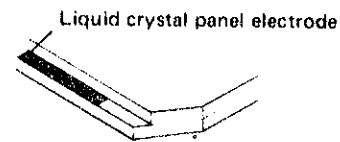

No foreign matter ... Normal  
Foreign matter ... Defective  
Wipe off any foreign matter.

- (2) **Check to see if the level of the MOS-IC output terminal is too low.**

- Raise, with tweezers, the MOS-IC output terminals connected to the segments which fail to light up or not.

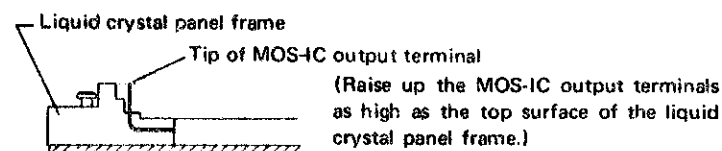

- After assembling the liquid crystal panel, check to see if the segments light up.

Light up ..... Normal  
Does not light up. Defective  
..... Proceed to



##### C Check liquid crystal panel and circuit block

After replacing the liquid crystal panel or the circuit block, check to see if the watch works correctly.

##### D Check current consumption

Check to see if the current consumption is normal.

First of all, pull out the lock switch button before applying the probes.  
Check current consumption:

- (1) When the lock switch button is pulled out.
- (2) When the lock switch button is normal position.

- Tester

Range to be used: DC 0.03 mA

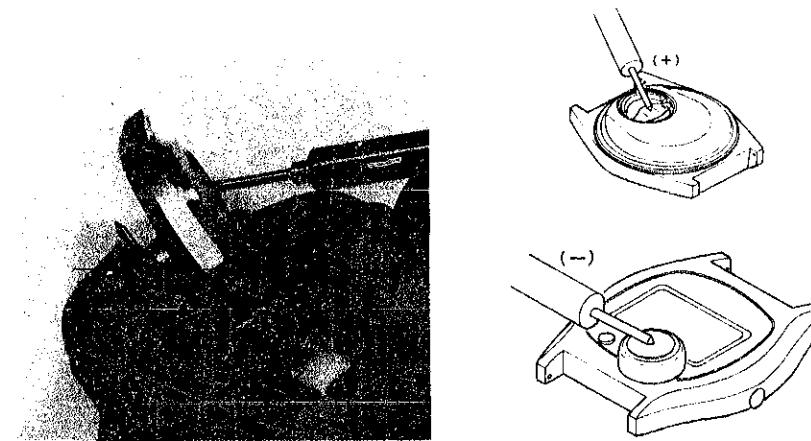

Probe Red (+) ..... Battery lead terminal (+)  
Probe Black (-) .... Battery surface (-)

##### E Check accuracy

- Use the electric-field detection microphone for QT-10.

(See "How to use Quartz Tester QT-10" on page 3.)

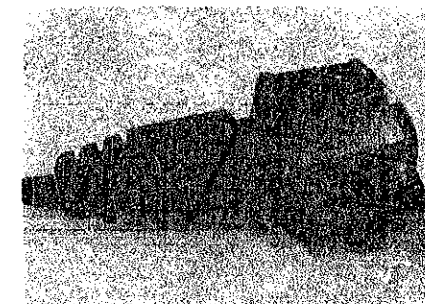

Be sure that the + side of the battery contacts the select button.

Less than 6  $\mu$ A: ..... Normal  
More than 6  $\mu$ A: ..... Defective

**F** Time accuracy adjusting

Time accuracy of Cal. 0680A is adjusted by turning the trimmer condenser.

• **Adjusting method**

The watch will gain or lose according to the direction in which the trimmer condenser is turned. Adjustment should therefore be made after ascertaining with the Quartz Tester whether the watch tends to gain or lose.



• **Note for handling the trimmer condenser**

Avoid excessive depressing and turning of the trimmer condenser.

• **Function of the Trimmer Condenser**

The trimmer condenser consists of a rotor electrode and a stator electrode as shown in the diagram.

Turning the shaft fixed to the rotor changes the overlapped area between the stator electrode and rotor electrode, which in turn changes the capacity of the trimmer condenser.

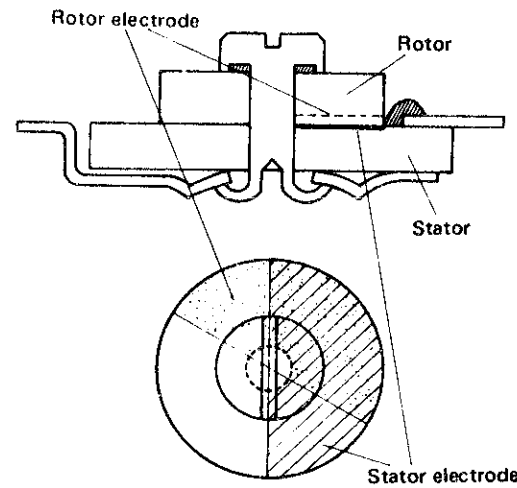

• **Change in the capacity of trimmer condenser and the adjusting accuracy rate.**

Turning the trimmer condenser changes its capacity as shown in the diagram.

The trimmer condenser has been so adjusted at the factory so as to let the watch gain when it is turned clockwise and vice versa. Whenever adjustment is needed, however, turn the trimmer condenser while examining the gain and loss by the Quartz Tester.

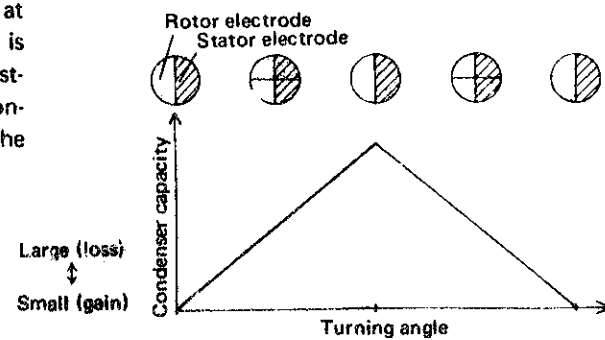

**G** Check time and date setting conditions

- (1) Check if the second dots blink exactly at every second, and if one minute is added after 60 blinks.
- (2) Check if the hour and minute setting is made correctly.

- Date Setting condition: More than 31 days.
- Hour setting condition: More than 12 hours.
- Minute setting condition: More than 60 minutes.

**H** Check setting mechanism

Check to see if the lock switch button and the time adjusting buttons work correctly.

(1) **Check to see if the lock switch button functions correctly**

- Check to see that the thin spring of the setting lever touches the unlock terminal when the lock switch button is pulled out, and that the thin spring of the setting lever is set apart from the unlock terminal when the lock switch button is pushed in.

**Remarks:**

- Make sure that there is no foreign matter (dust, lint, etc.) on the thin spring of the setting lever and unlock terminal contacts.

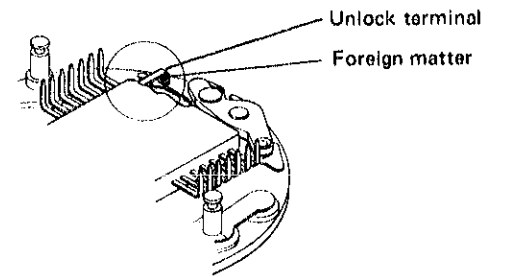

(2) **Check to see if the setting button functions correctly.**

- Check to see if the setting switch spring is touched to the pin of the circuit board as shown in the illustration. If it touches, correct it with tweezers.

**Remarks:**

- Make sure that there is no foreign matter (dust, lint) between the setting switch spring and the pin of the circuit board. Wipe off dust and lint if there is any.

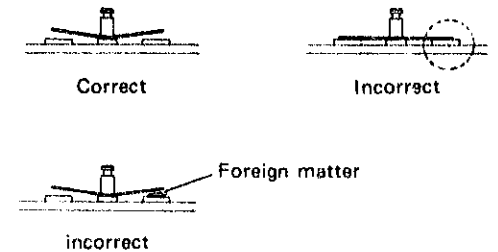

**I** Check bulb

Check the bulb is not burned out

(1) **Set the tester**

Range to be used: OHMS R x 1

(2) **Checking**

Contact the two probes of the tester to the lamp fixing screw

If the lamp is lit . . . . . normal  
 If the lamp is not lit . . . . . defective  
 (change the lamp)



## V. PACKING AND MAINTENANCE OF THE SPARE PARTS

### ● Packing and maintenance of the spare parts

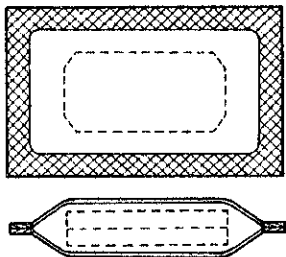
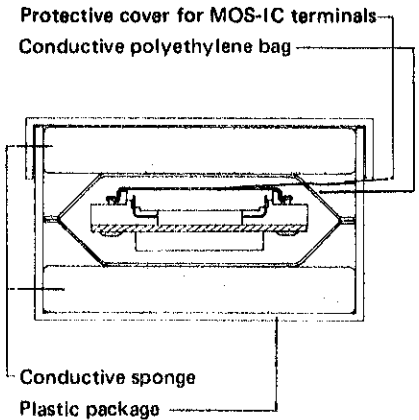
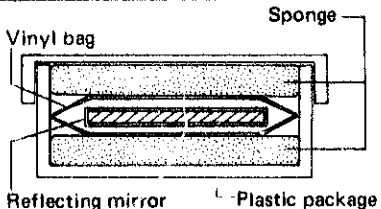
Parts name	Packing method	Remarks
Liquid crystal panel	<ul style="list-style-type: none"> <li>● Aluminum pack (airtight packing)</li> </ul>  <p>(The package protects the liquid crystal panel from sunlight and humidity.)</p>	<ul style="list-style-type: none"> <li>● Keep the liquid crystal panel in the following place to maintain the high quality.               <ol style="list-style-type: none"> <li>1. Dark place</li> <li>2. Low humidity</li> <li>3. Low temperature</li> </ol> </li> </ul>
Circuit block <ul style="list-style-type: none"> <li>● Circuit block</li> <li>● Setting lever</li> <li>● Setting lever spring</li> <li>● Setting switch spring</li> <li>● Liquid crystal panel frame</li> <li>● Protective cover for MOS-IC terminals</li> </ul>	 <p>Protective cover for MOS-IC terminals Conductive polyethylene bag</p> <p>Conductive sponge Plastic package</p>	<ul style="list-style-type: none"> <li>● MOS-IC is protected with the following three materials from static electricity.               <ol style="list-style-type: none"> <li>1. Protective cover for MOS-IC terminals</li> <li>2. Conductive polyethylene bag</li> <li>3. Conductive sponge</li> </ol> </li> <li>● The MOS-IC terminal is protected from being bent with the liquid crystal panel frame.</li> <li>● The tip of the MOS-IC terminal is smeared with silicon grease for rust prevention</li> </ul>
Reflecting mirror	 <p>Vinyl bag Sponge</p> <p>Reflecting mirror Plastic package</p>	<ul style="list-style-type: none"> <li>● Be careful not to break the reflecting mirror (glass).</li> </ul>
<ul style="list-style-type: none"> <li>● Setting lever</li> <li>● Setting switch spring</li> </ul>	<ul style="list-style-type: none"> <li>● Blister package</li> </ul>	<ul style="list-style-type: none"> <li>● Be careful not to bend.</li> </ul>
Liquid crystal panel frame Spring for liquid crystal panel Setting lever spring Battery guard Bulb	<ul style="list-style-type: none"> <li>● Vinyl bag</li> </ul>	