















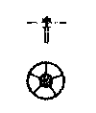

















Cal. 2406A











### Characteristics











Casing diameter: 19.00<sup>φ</sup> mm  
 Maximum height: 4.58 mm  
 Vibrations per hour: 28,800  
 Automatic and auxiliary hand winding with sweep second  
 Calendar (day & date)  
 Instant setting device for day & date calendar  
 Bilingual change-over system for day of week  
 "Diashock" Shock Resistant Device































































Catalog No.

Calibre No.	Jewels	Style Name	
<b>2406A</b>	<b>23j</b>		
PART NO.	LIST OF MATERIALS	PART NO.	LIST OF MATERIALS
112 240	Barrel & train-wheel bridge	817 240	Intermediate date wheel
122 240	Center wheel bridge	848 240	First reverser idler
161 240	Pallet cock	851 240	Second reverser idler
171 240	Balance cock	868 240	Day finger
191 240	Framework for automatic device	☆870 166	Day star with dial disk
201 240	Complete barrel with arbor & mainspring	☆870 240	
224 240	Center wheel & pinion with cannon pinion	873 240	Day jumper
225 240	Cannon pinion	☆884 247	Holding ring for dial
231 240	Third wheel & pinion	011 157	Lower hole jewel for 1st reverser idler
241 240	Fourth wheel & pinion	011 157	Upper hole jewel for 1st reduction wheel
245 240	Sweep second pinion	011 157	Lower hole jewel for 1st reduction wheel
251 240	Escape wheel & pinion	011 168	Lower hole jewel for sweep second pinion
261 240	Minute wheel	011 212	Diashock upper cap jewel
271 240	Hour wheel	011 212	Diashock lower cap jewel
282 240	Clutch wheel	011 422	Upper hole jewel for differential wheel
283 240	Winding pinion	011 422	Lower hole jewel for differential wheel
284 240	Crown wheel	011 505	Upper hole jewel for escape wheel
285 240	Ratchet wheel	011 505	Lower hole jewel for escape wheel
301 110	Jewelled pallet fork & staff	011 505	Upper hole jewel for pallet
310 240	Balance complete with stud	011 505	Lower hole jewel for pallet
315 240	Balance staff	011 521	Upper hole jewel for center wheel
331 110	Roller with jewel	011 521	Lower hole jewel for center wheel
341 240	Regulator	011 541	Upper hole jewel for 4th wheel
345 240	Stud holder	011 541	Lower hole jewel for 4th wheel
☆354 240	Winding stem	011 542	Upper hole jewel for 3rd wheel
☆354 241		011 542	Lower hole jewel for 3rd wheel
☆354 242		012 123	Stud screw
372 240	Joint stem (movement portion)	012 126	Center wheel bridge screw
373 250	Joint stem (case portion)	012 126	Minute wheel bridge screw
381 240	Click	012 133	Friction spring screw for sweep second pinion
382 030	Click spring	012 275	Bridge screw
☆383 240	Setting lever	012 275	Balance cock screw
☆383 241		012 275	Framework screw for automatic device
☆383 242		012 297	Crown wheel screw
☆383 243		012 421	Transmission wheel screw
384 240	Yoke (Clutch lever)	012 762	Dial screw
387 240	Minute wheel bridge	012 763	Pallet cock screw
388 240	Setting lever spring	012 764	Casing clamp screw
390 240	Setting lever axle	012 767	Setting lever spring screw
396 240	Friction spring for sweep second pinion	012 767	Day jumper screw
399 003	Casing clamp	012 767	Date driving wheel screw
464 240	Holding ring for setting wheel lever complete	012 767	Screw for setting wheel lever complete
481 240	Crown wheel ring	013 064	Tube for screw of setting wheel lever complete
491 180	Dial washer	013 065	Tube for yoke
493 070	Hour wheel ring		(Tube for barrel & train-wheel bridge screw)
499 240	Day finger ring	013 834	Click pin
505 240	Transmission wheel	013 836	Second reduction wheel pin
509 240	Oscillating weight with ball-bearing	013 837	Date dial guard pin
511 240	First reduction wheel	014 413	Diashock upper frame
514 240	Second reduction wheel	014 414	Diashock lower frame
531 240	Differential wheel	014 415	Diashock hole jewel with frame
556 240	Date finger	014 417	Diashock spring
☆801 240	Date dial		
☆801 244			
802 240	Date driving wheel		
803 240	Setting wheel lever complete		
808 240	Date dial guard		
810 240	Date jumper		

☆⇨ Please see remarks on the next page.

Items in light letters are not shown in photos.

Calibre No. <b>2406A</b>	Jewels <b>23j</b>	Style Name
-----------------------------	----------------------	------------

**Remarks :**

**Winding stem** — There are three types of winding stems. Select a suitable one by referring to the photographs on the front page and the shapes in the lower diagram.

- ☆354 240..... a size is **1.26 mm** and thread is provided completely on the crown portion.
- ☆354 241..... a size is **3.80 mm** and thread is provided only on the end of the crown portion.
- ☆354 242..... a size is **1.26 mm** and thread is provided only on the end of the crown portion.

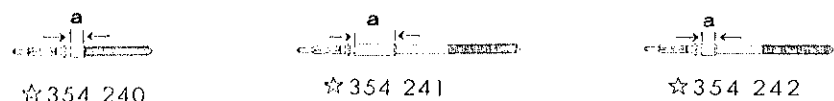

**Setting lever**

There are four types of setting levers. They are used according to the shapes of dial, structures of case and types of winding stem. Select a suitable one by the following procedures referring to the shapes indicated in Fig. 1.

☆383 240..... Used for watch with joint stem, or with ordinary winding stem other than one-piece or square-type water-resistant case.

☆383 241 }  
 ☆383 242 } ... Those setting levers are used for one-piece or square-type water-resistant case with ordinary winding stem. Select the setting lever whose tail can be set between the dial and the case as shown Fig. 2 when assembling the movement in the case by referring to the shapes in Fig. 1. If an incorrect setting lever for dial diameter is used, the winding stem can not be pulled out or the movement can not be set in the case. Attention must be paid to this point.

When part number of the setting lever is unknown, specify ① Cal. No. ② jewels ③ dial No. and ④ case No.

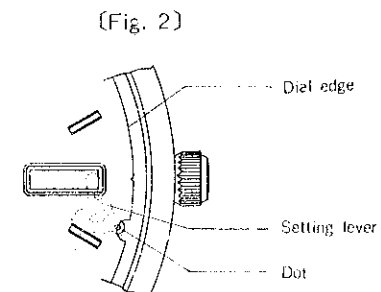
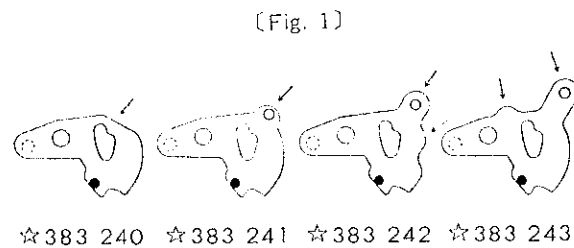

(Example of suitable setting lever)  
 Tail of the setting lever is located between the dial and the case.

**Date dial**

- ☆801 240..... Used when both the crown and the date frame are located at **3 o'clock** position.
- ☆801 244..... Used when the crown is located at **3 o'clock** position and the date frame at **6 o'clock** position.

If the date dial is required in any other type, specify ① Cal. No. ② jewels ③ the crown position ④ the date frame position and ⑤ dial No.

**Day star with dial disk**

- ☆870 166(English ↔ Japanese) ..... Used when the crown is located at **3 o'clock** position and the day frame at **6 o'clock** position.
- ☆870 240(English ↔ Japanese) ..... Used when both the crown and the day frame are located at **3 o'clock** position.

If the day star with dial disk is required in any other type, specify the number printed on the disk.

— continued on reverse page —

Calibre No. <b>2406A</b>	Jewels <b>23j</b>	Style Name
-----------------------------	----------------------	------------

**Remarks :** — continued —

**Holding ring for dial** — The holding ring for dial differs according to the design of the dial. Select the suitable one by the following procedures.

☆884 247..... Refer to the photograph on the front page and Fig. 1.

When ordering the other part than the above, specify the part number printed in the **12 o'clock** direction of the dial.

If the part number of the holding ring for dial is unknown, specify ① Cal. No. ② jewels ③ dial No. and ④ case No.

(Fig. 1)

(Fig. 2)

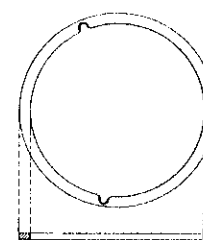

☆884 247

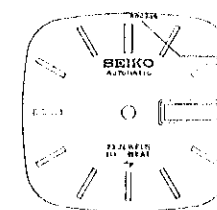

The part number of the holding ring for dial to be used for this dial.

# 2406A (2409, 2415, 2418 derived from this calibre)

## 2406A Calendar and Setting Mechanisms

### (1) Specifications

Casing diameter 19.00mm  
 Height 4.58mm  
 Vibrations per hour 28,800

(8 beats per second)

Automatic winding (with auxiliary hand winding mechanism)

Setting wheel lever system

Calendar (day, date, Bilingual change-over mechanism for day indication and Instant day and date setting mechanism)

### (2) Features

Thin and dress type automatic, multifunctional winding watch

Movement size is designed in two types for Ladies' and Gents' watch as 24 series calibres list below.

**High-Vibration watch with stabilized time accuracy**

By adopting a high-vibration mechanism (8 beats), exceptional timing accuracy is maintained. Winding capacity, which is the life of the automatic winding watch, has been ingeniously devised, creating a reliable timepiece.

**Simple day & date setting mechanism**

The day and date setting mechanism is also compactly designed around the second setting lever. This makes it extremely easy to disassemble and assemble the parts, and the regularity of the day and date mechanism maintained with steadiness.

**(3) Disassembling and Assembling**

Disassemble watch as in Fig. ① → ⑤⑨

Assemble watch as in Fig. ⑤⑨ → ①

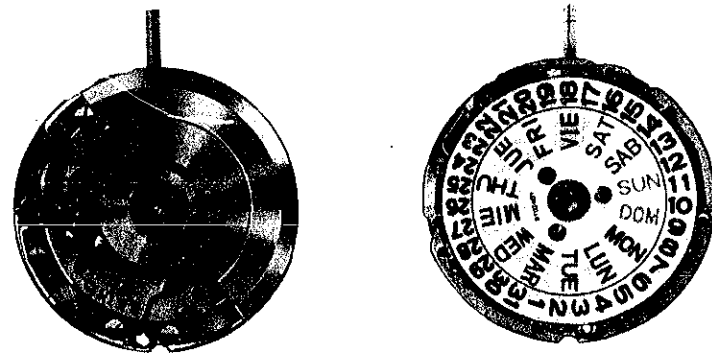

MOVEMENT

### (4) Lubrication

The following symbols in the illustrated figures indicate the types of oil, the quantities to be applied, and the lubricating points.

#### Types of oil

- SEIKO watch oil S-6
- SEIKO watch oil S-4
- SEIKO watch oil S-3
- Moebius synt-A-Lube
- Moebius synt-V-Lube

#### Oil quantity

- : Extremely small quantity
- : Normal quantity
- : Sufficient quantity

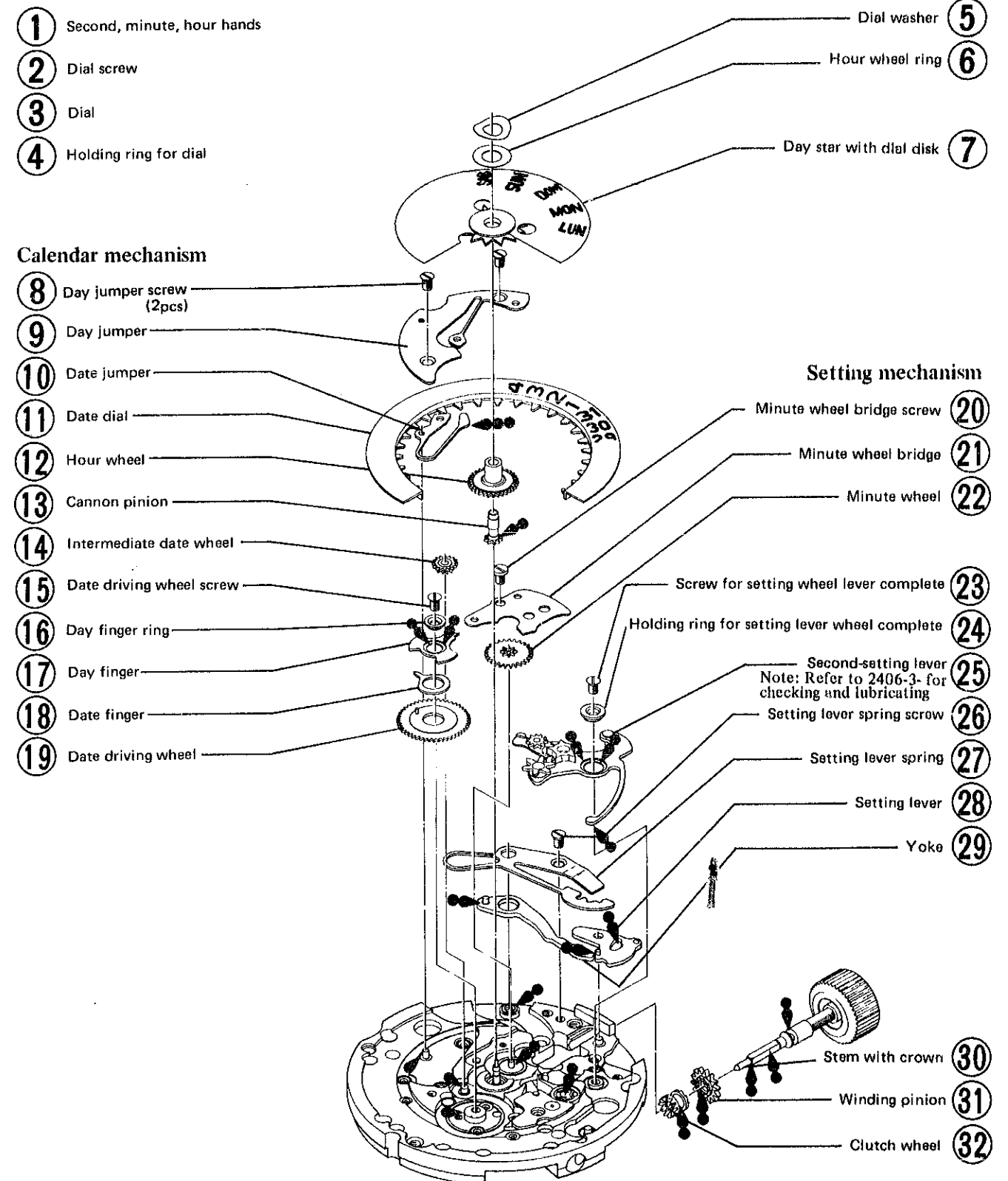

### 24 SERIES CALIBRES AND THEIR FEATURES

Calibre No.	Casing diameter (mm)	Height (mm)	Train wheel Mechanism		Calendar			Day date correcting	
			hour & minute hands	Sweep second	Date	Day	Bilingual change-over mechanism	Date correcting	Day correcting
2406	19.0	4.5		o	o	o	o	o	o
2415	19.0	4.5	o		o			o	
2409	24.0	4.5		o	o	o	o	o	o
2418	24.0	4.5	o		o			o	

# 2406A Automatic winding, Train wheel, Escapement and Governor Mechanisms

## Notes on disassembling and assembling

### How to remove hands

Since the dial is thin and easy to bend, use a bow-type hand remover when detaching hands.



### Dial washer

The bending should be 20/100 - 40/100mm (0.7 - 1.5 times thickness of dial)

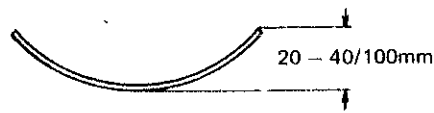

### Hour wheel ring

This is used when shake of hour wheel (day star with dial disk) is more than 8/100mm. (When shaking is more than 1/4 dial thickness or thickness of day star with dial disk).

### Yoke spring (Clutch lever spring)

Set yoke spring at position shown in diagram. When removing setting lever spring screw, be careful the screw will not spring out.

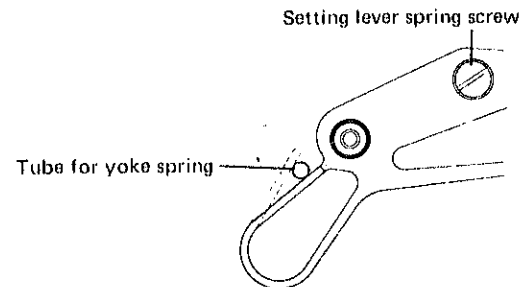

### Pushing in cannon pinion

Push in cannon pinion after assembling barrel and train wheel bridge to prevent shake of center wheel and pinion from becoming excessive.

### Assembling day finger and date finger

When assembling day finger, carefully note position of date driving wheel pin. Assemble date finger by placing bent surface upward.

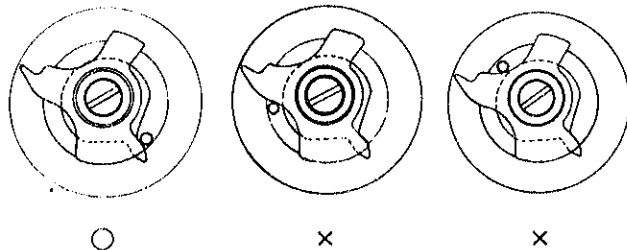

## Checking on second-setting lever

### 1) Structure of second-setting lever

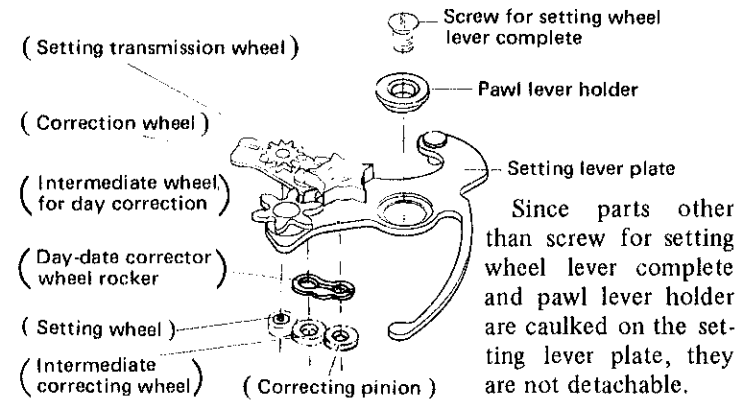

### 2) Lubricating points on second-setting lever

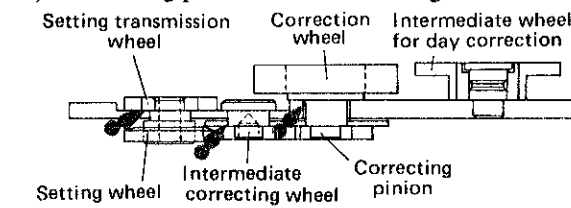

Apply oil from clearances between Second setting lever complete and Intermediate correcting wheel, Correcting pinion and Setting wheel.

### 3) Checking performance of day-date corrector wheel rocker

Before assembling second-setting lever, check day-date corrector wheel rocker to note whether or not it moves smoothly along the long hole when correction wheel is moved with a small brush or a pair of tweezers.

Note) If excessive oil is applied to day-date corrector wheel rocker, motion of day-date corrector wheel rocker will become defective due to adhesion of second-setting lever complete and day-date corrector wheel rocker.

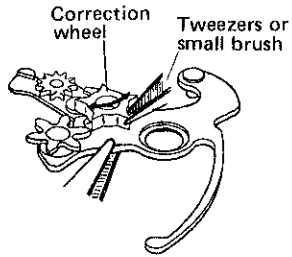

### 4) Precautions on assembling second-setting lever to plate

After setting second-setting lever pin in hole of setting lever and tightening screw for setting wheel lever complete, set second-setting lever by bending its tail portion in direction of arrow.

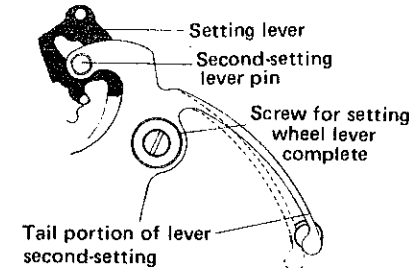

## Oscillating weight

- 1) Since groove of the oscillating weight screw has a curve, use a driver as shown on the right.
- 2) Be careful in pressing the oscillating weight screw here, since if forcibly pressed, the bearing axle may come off.

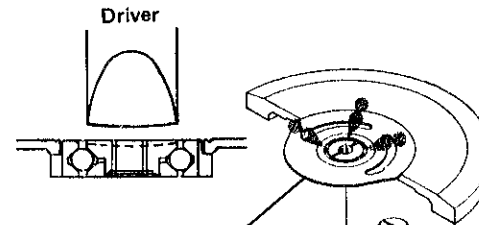

## Automatic winding mechanism

- 33 Oscillating weight
- 34 Framework screw for automatic device (2pcs)
- 35 Framework for automatic device
- 36 Differential wheel
- 37 First reduction wheel
- 38 Crown wheel screw
- 39 Crown wheel ring
- 40 Crown wheel
- 41 Barrel & train-wheel bridge screw (4 pcs)
- 42 Barrel & train-wheel bridge
- Do not detach transmission wheel and first reverser idler (If you have to disassemble, refer to the next page)
- (Second reduction wheel) When lubricating, refer to the next page.

## Train wheel mechanism

- 43 Third wheel & pinion
- 44 Sweep second wheel & pinion
- 45 Escape wheel
- 46 Friction spring screw for sweep second pinion
- 47 Friction spring for sweep second pinion
- 48 Sweep second pinion

## Escapement and Governor mechanism

- 55 Balance cock screw
- 56 Balance Complete
- 57 Pallet cock screw
- 58 Pallet cock
- 59 Pallet
- 49 Center wheel bridge screw
- 50 Center wheel bridge
- 51 Second reverser idler
- 52 Center wheel and pinion with cannon pinion
- 53 Ratchet wheel
- 54 Complete barrel with arbor

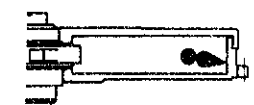

It is unnecessary to disassemble the complete barrel with arbor. When it is disassembled and washed inadvertently, use the SEIKO oil S-3.

## 2406A Setting Mechanism

### Note on disassembling and assembling

#### Assembling crown wheel and ratchet wheel

When assembling the crown wheel and the ratchet wheel, do not mistake their front with rear surfaces.

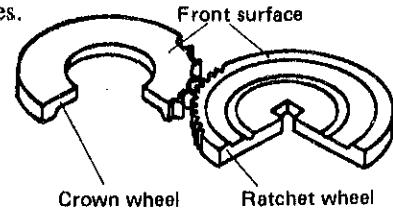

#### Framework for automatic device

Since the second reduction wheel is caulked on the framework for automatic device, they are not detachable from each other.

Apply oil from this crescent-shaped groove of second reduction wheel pin.

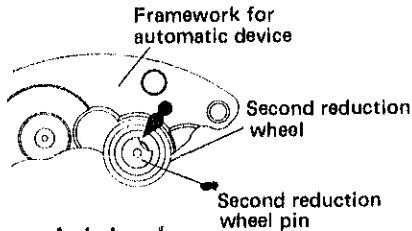

#### Lubricating Third wheel lower hole jewel

Since clearance between third wheel lower hole jewel and center wheel and pinion with cannon pinion is small, apply oil only in small quantity to third wheel lower hole jewel.

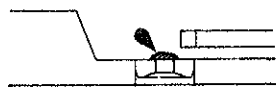

#### Disassembling Transmission wheel and First reverser idler

Do not detach transmission wheel and first reverser idler as they are difficult to assemble. Wash them together as they are, with the barrel and train wheel bridge.

If you have to disassemble, first place barrel and train wheel bridge on the reverting stake; and then insert first reverser idler in the hole of the reverting stake. Next, take them apart by loosening transmission wheel screw after inserting the tip of the screw-driver into the clearance between the teeth of transmission wheel and stopping its revolution.

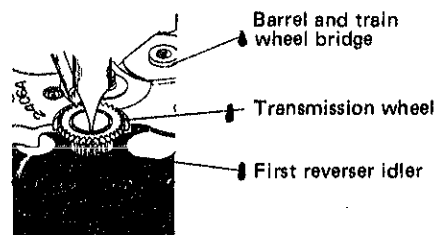

#### Lubrication

Lubricate them through clearance between barrel & train wheel bridge and first reverser idler.

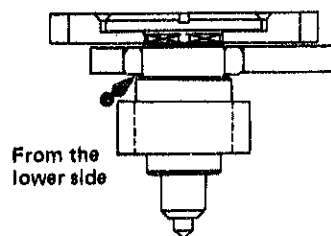

### Checking on locking and smooth idling of differential wheel

#### 1) Checking on differential wheel

Using a small brush or soft material, confirm locking and smooth idling for both the upper and lower wheels before assembling differential wheel.

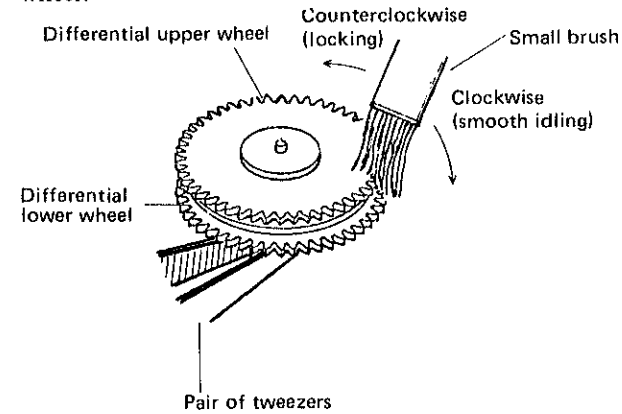

Facing the pinion lower side . . .  
Clockwise . . . Revolves smoothly (SMOOTH IDLING)

Counterclockwise . . . Stops after moving slightly (LOCKING)

#### 2) Checking on the differential wheel with oscillating weight smooth idling

Should oscillating weight revolve over 180° after the crown is wound 5 revolutions and released by 2.5 revolutions, this is a sign that some wheel motion is not functioning properly.

Check the following if this happens.

- o Check on malfunction of the differential wheel
- o Check if there is an insufficiency of shake in sections of automatic winding and train wheel

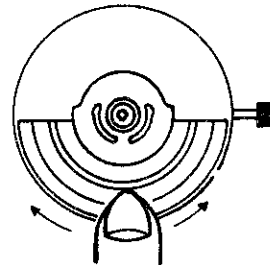

#### Checking on fault in locking

Turn differential wheel by moving oscillating weight clockwise and counterclockwise each 90° ten times alternately. At this time, should oscillating weight reverse over 45°, this indicates a malfunction in locking.

Clean differential wheel with benzine or S-clean.

It is not necessary to lubricate inside differential wheel which is self-greasing.

### Normal position of crown (winding the mainspring)

In the position with winding pinion and clutch wheel interlocked, the mainspring is wound manually. (Fig. 1)

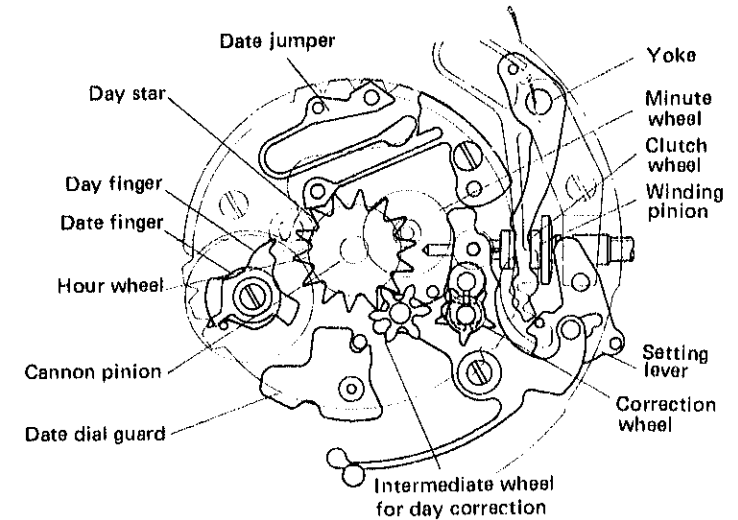

Fig. 1

### First click of crown (correction of day and date)

When clutch wheel and setting wheel are interlocked, and crown is rotated clockwise, day-date corrector wheel rocker moves toward day star with dial disk side, and permits day setting. (Fig. 2)

When crown is rotated counterclockwise, day-date corrector wheel rocker moves towards date dial, allowing date adjustment.

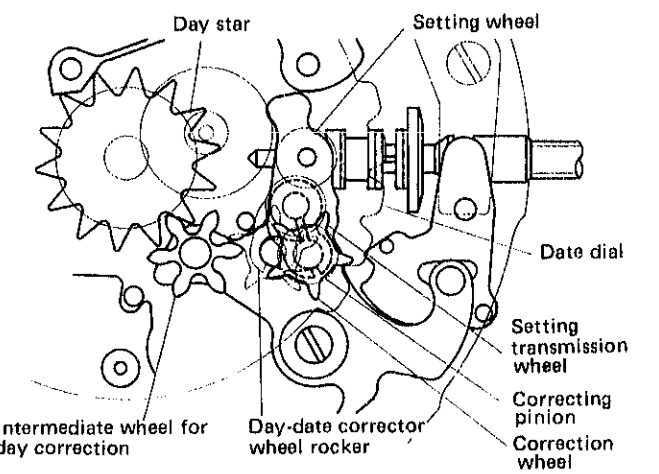
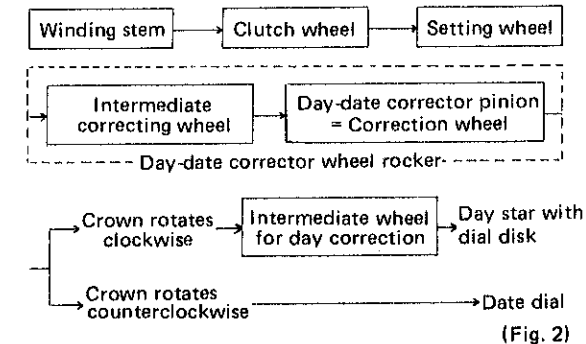

Fig. 2

### Second click of crown (setting time)

The second setting lever moves, pressed by setting lever and setting transmission wheel attached to setting wheel lever complete and interlocks with minute wheel. In this position, setting by hand is possible when crown is revolved. (Fig. 3)

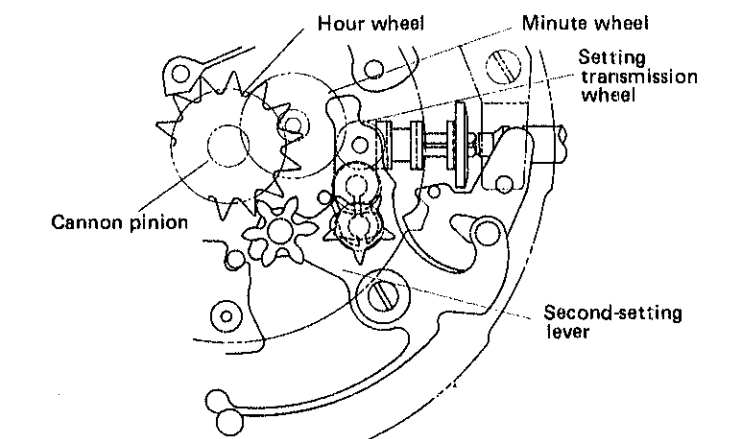
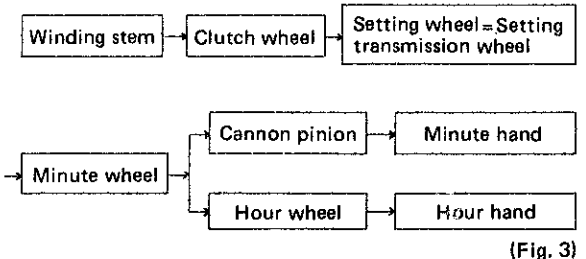

Fig. 3