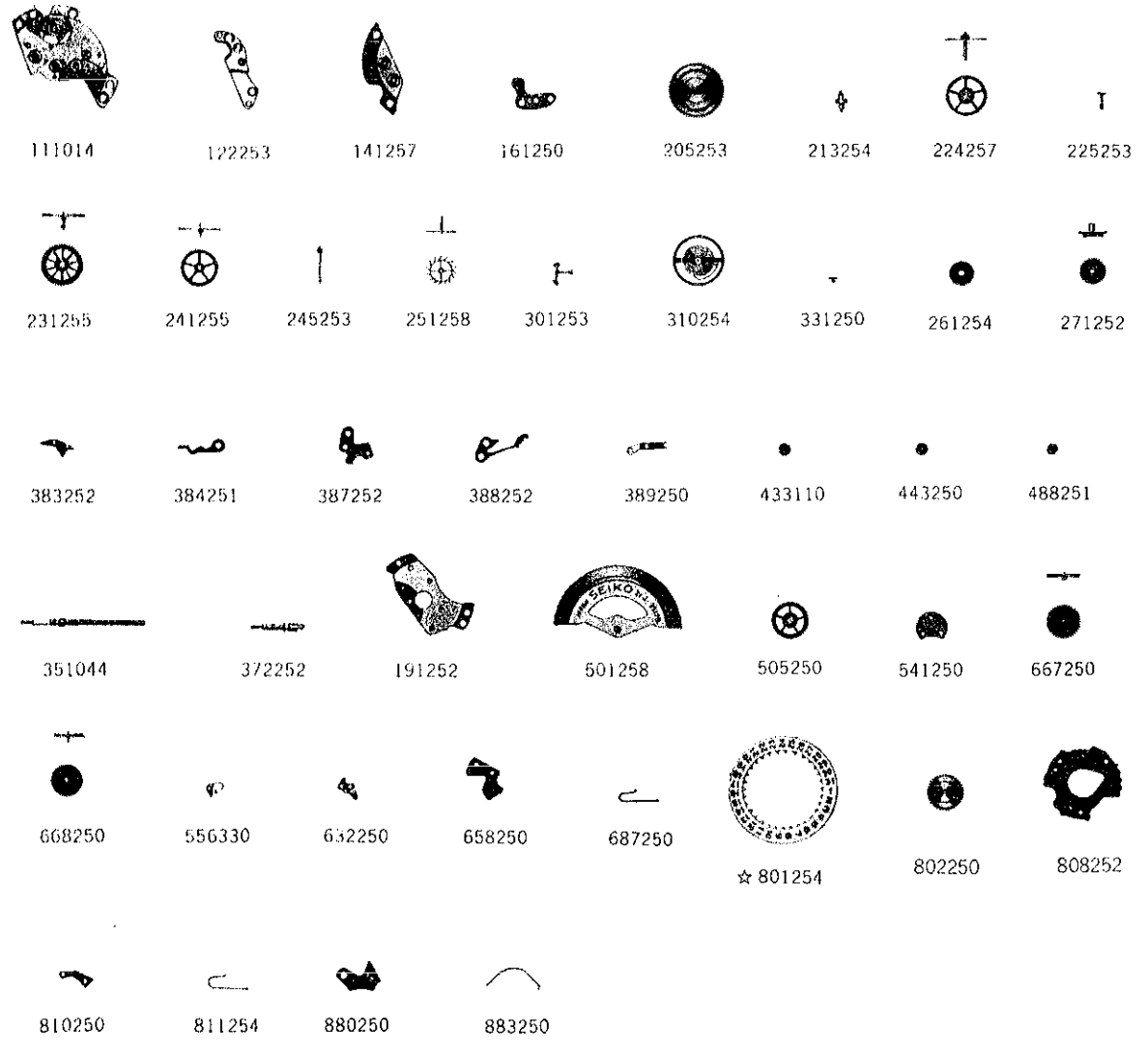

Calibre No. <b>2517B</b>		Jewels <b>21j</b>	Style Name
⇨ Basic Calibre 2501A 17J Catalog No. 25-01-1			
 <p>Cal. 2517B</p>		<b>Characteristics</b> Casing diameter: 17.20 <sup>φ</sup> mm Maximum height: 5.85 mm Vibrations per hour: 19,800 Automatic winding with sweep second Calendar (date) Pull & push instant date setting "Diashock" Shock Resistant Device	
			
<div style="display: flex; justify-content: space-between;"> <span>012219</span> <span>012301</span> <span>012727</span> <span>390252</span> <span>2/1</span> </div>			

Catalog No. 25-17-2

Calibre No. <b>2517B</b>		Jewels <b>21j</b>	Style Name
⇨ Basic Calibre 2501A 17J Catalog No. 25-01-1			
PART NO.	LIST OF MATERIALS	PART NO.	LIST OF MATERIALS
111014	Barrel bridge	011212	Diashock cap jewel
122253	Center wheel bridge	014417	Diashock spring
141257	Fourth wheel bridge	501258	Oscillating weight with pinion
161250	Pallet cock	505250	Transmission wheel
171250	Balance cock	541250	Oscillating weight axle
191252	Framework for automatic device	545030	Oscillating weight fork
205253	Complete barrel with arbor	667250	First locking wheel
213254	Barrel arbor	668250	Second locking wheel
224257	Center wheel & pinion with cannon pinion	556330	Date finger
225253	Cannon pinion	632250	Date corrector finger
231255	Third wheel & pinion	658250	Date corrector guard
241255	Fourth wheel & pinion	687250	Date corrector finger spring
245253	Sweep second pinion	☆ 801254	Date dial
251258	Escape wheel & pinion	802250	Date driving wheel
261254	Minute wheel	808252	Date dial guard
271252	Hour wheel	810250	Date jumper
281250	Setting wheel	811254	Date jumper spring
282250	Clutch wheel	880250	Date corrector
283250	Winding pinion	883250	Date corrector spring
284250	Crown wheel	012118	Barrel bridge screw, short
285250	Ratchet wheel	012118	Fourth wheel bridge screw
301253	Jewelled pallet fork & staff	012118	Balance cock screw
310254	Balance complete with stud	012118	Setting lever axle spring screw
315250	Balance staff	012120	Dial screw
331250	Roller with jewel	012121	Stud screw
341250	Regulator	012204	Pallet cock screw
345250	Stud holder	012219	Center wheel bridge screw
351044	Winding stem	012241	Framework screw for automatic device
372252	Joint stem (movement portion)	012252	Barrel bridge screw, long
373250	Joint stem (case portion)	012301	Date corrector spring screw
381030	Click	012407	Case screw
382030	Click spring	012501	Crown wheel screw
383252	Setting lever	012642	Click screw
384251	Yoke (Clutch lever)	012711	Screw for oscillating weight axle
385250	Yoke spring (Clutch lever spring)	012727	Minute wheel bridge screw
387252	Minute wheel bridge	012727	Date dial guard screw
388252	Setting lever spring	012727	Date corrector guard screw
389250	Setting lever axle spring	012744	Screw for oscillating weight fork
390252	Setting lever axle	011521	Upper hole jewel for center wheel
401030	Mainspring with slipping attachment (self-greasing)	011153	Lower hole jewel for center wheel
433110	Upper hole jewel with frame for escape wheel	011423	Lower hole jewel for 3rd wheel
443250	Upper hole jewel with frame for 3rd wheel	011423	Lower hole jewel for 4th wheel
443250	Upper hole jewel with frame for 4th wheel	011713	Lower hole jewel for sweep second pinion
481250	Crown wheel ring	011528	Lower hole jewel for escape wheel
488251	Upper hole jewel with frame for sweep second pinion	011505	Upper hole jewel for pallet
491180	Dial washer	011505	Lower hole jewel for pallet
014413	Diashock upper frame	011157	Upper hole jewel for transmission wheel
014414	Diashock lower frame	011157	Lower hole jewel for transmission wheel
014415	Diashock hole jewel with frame	013106	Tube for minute wheel bridge screw (Cylinder type)
		013113	Tube for bridge screw, short
		013175	Tube for minute wheel bridge screw (Recessed type)
		013176	Tube for bridge screw, long
<b>Remarks :</b>			
Date dial			
☆ 801254 .....Used when both the crown and the date frame are located at 3 o'clock.			
If the date dial is required in any other type, specify ① Cal. No. ② the crown position			
③ the date frame position and ④ the dial No.			

☆⇨ Please see remarks on the reverse page.  
As for all other parts not shown here, please refer to the basic calibre (Cal. No. 2501A 17J Catalog No. 25-01-1 Red page).

☆⇨ Please see remarks.  
Items in light letters are not shown in photos; those parts are interchangeable with the basic calibre (Cal. No. 2501A 17J Catalog No. 25-01-1 Red page).

Calibre No.	<b>2517B</b>	Jewels	<b>17j</b>	Style Name	
⇨ Basic Calibre 2501A 17J Catalog No. 25-01-1					



Cal. 2517B

**Characteristics**

Casing diameter : 17.20φmm  
 Maximum height : 5.85 mm  
 Vibrations per hour : 19,800  
 Automatic winding with sweep second  
 Calendar (date)  
 Pull & push instant date setting  
 "Diashock" Shock Resistant Device

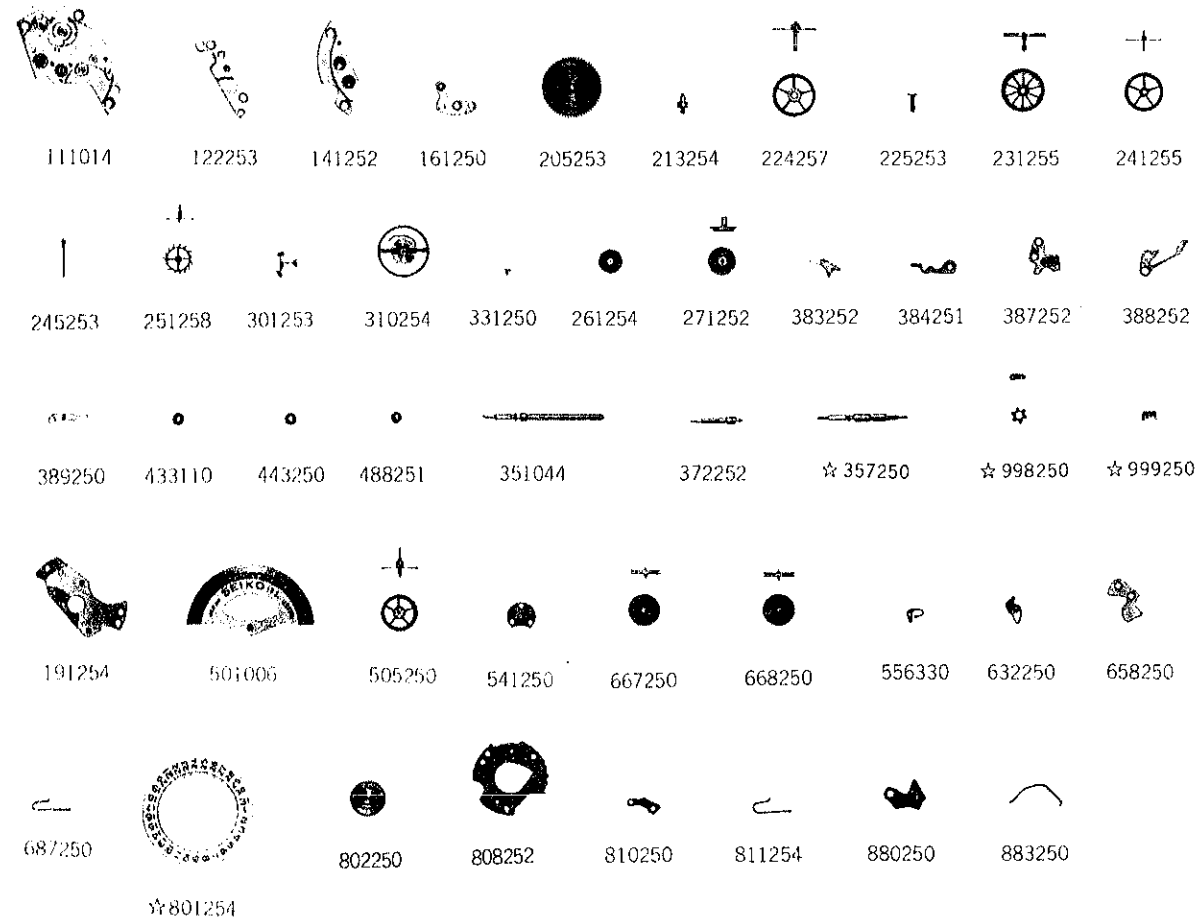

111014 122253 141252 161250 205253 213254 224257 225253 231255 241255  
 245253 251258 301253 310254 331250 261254 271252 383252 384251 387252 388252  
 389250 433110 443250 488251 351044 372252 ☆357250 ☆998250 ☆999250  
 191254 501006 505250 541250 667250 668250 556330 632250 658250  
 687250 802250 808252 810250 811254 880250 883250  
 ☆801254

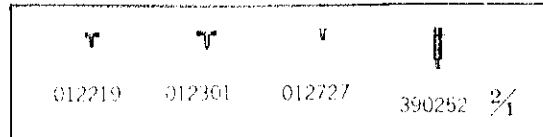

012219 012301 012727 390252 2/4

☆ ⇨ Please see remarks on the reverse page.  
 As for all other parts not shown here, please refer to the basic calibre (Cal. No. 2501A 17J Catalog No. 25-01-1 Red page).

Calibre No.	<b>2517B</b>	Jewels	<b>17j</b>	Style Name	
⇨ Basic Calibre 2501A 17J Catalog No. 25-01-1					

PART NO.	LIST OF MATERIALS	PART NO.	LIST OF MATERIALS
111014	Barrel bridge	014415	Diashock hole jewel with frame
122253	Center wheel bridge	011212	Diashock cap jewel
141252	Fourth wheel bridge	014417	Diashock spring
161250	Pallet cock	501006	Oscillating weight with pinion
171250	Balance cock	505250	Transmission wheel
191254	Framework for automatic device	541250	Oscillating weight axle
205253	Complete barrel with arbor	545030	Oscillating weight fork
213254	Barrel arbor	667250	First locking wheel
224257	Center wheel & pinion with cannon pinion	668250	Second locking wheel
225253	Cannon pinion	556330	Date finger
231255	Third wheel & pinion	632250	Date corrector finger
241255	Fourth wheel & pinion	658250	Date corrector guard
245253	Sweep second pinion	687250	Date corrector finger spring
251258	Escape wheel & pinion	☆801254	Date dial
261254	Minute wheel	802250	Date driving wheel
271252	Hour wheel	808252	Date dial guard
281250	Setting wheel	810250	Date jumper
282250	Clutch wheel	811254	Date jumper spring
283250	Winding pinion	880250	Date corrector
284250	Crown wheel	883250	Date corrector spring
285250	Ratchet wheel	012118	Barrel bridge screw, short
301253	Jewelled pallet fork & staff	012118	Fourth wheel bridge screw
310254	Balance complete with stud	012118	Balance cock screw
315250	Balance staff	012118	Setting lever axle spring screw
331250	Roller with jewel	012120	Dial screw
341250	Regulator	012121	Stud screw
345250	Stud holder	012204	Pallet cock screw
☆351044	Winding stem	012219	Center wheel bridge screw
357250	Joint stem (movement portion)	012241	Framework screw for automatic device
372252	Joint stem (case portion)	012252	Barrel bridge screw, long
373250	Click	012301	Date corrector spring screw
381030	Click spring	012407	Case screw
382030	Setting lever	012501	Crown wheel screw
383252	Yoke (Clutch lever)	012642	Click screw
384251	Yoke spring (Clutch lever spring)	012711	Screw for oscillating weight axle
385250	Minute wheel bridge	012727	Minute wheel bridge screw
387252	Setting lever spring	012727	Date dial guard screw
388252	Setting lever axle spring	012727	Date corrector guard screw
389250	Setting lever axle	012744	Screw for oscillating weight fork
390252	Mainspring with slipping attachment (self-greasing)	011521	Upper hole jewel for center wheel
401030	Upper hole jewel with frame for escape wheel	011153	Lower hole jewel for center wheel
433110	Upper hole jewel with frame for 3rd wheel	011423	Lower hole jewel for 3rd wheel
443250	Upper hole jewel with frame for sweep second pinion	011713	Lower hole jewel for sweep second pinion
481250	Crown wheel ring	011528	Lower hole jewel for escape wheel
488251	Upper hole jewel with frame for sweep second pinion	011505	Upper hole jewel for pallet
491180	Dial washer	011505	Lower hole jewel for pallet
☆998250	Indicator wheel	013106	Tube for minute wheel bridge screw (Cylinder type)
☆999250	Indicator wheel spring	013113	Tube for bridge screw, short
014413	Diashock upper frame	013175	Tube for minute wheel bridge screw (Recessed type)
014414	Diashock lower frame	013176	Tube for bridge screw, long

**Remarks :** ☆357250 (Winding stem)  
 ☆998250 (Indicator wheel)  
 ☆999250 (Indicator wheel spring) } These parts are available only for watches with rotating dial ring.  
 ☆801254 (Date dial) ..... Used when both the crown and the date frame are located at 3 o'clock.  
 If the date dial is required in any other type, specify ① Cal. No. ② the crown position  
 ③ the date frame position and ④ the dial No.

☆ ⇨ Please see remarks.  
 Items in light letters are not shown in photos; those parts are interchangeable with the basic calibre (Cal. No. 2501A 17J Catalog No. 25-01-1 Red page).

Catalog No. 25-17-3

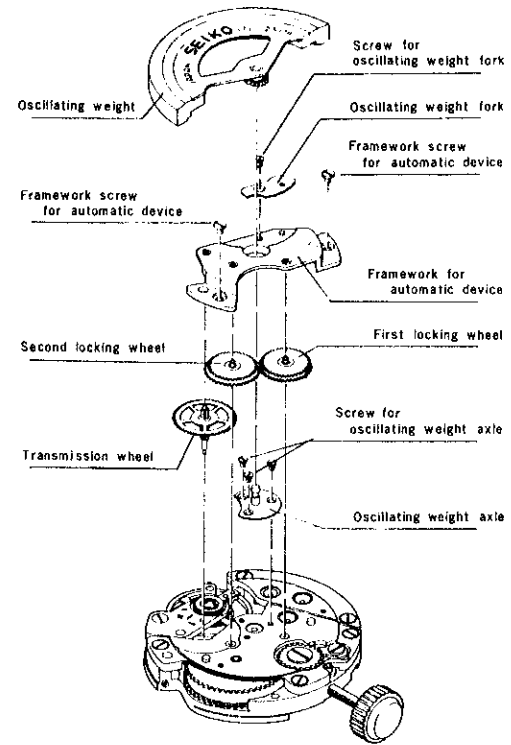

Fig. 1

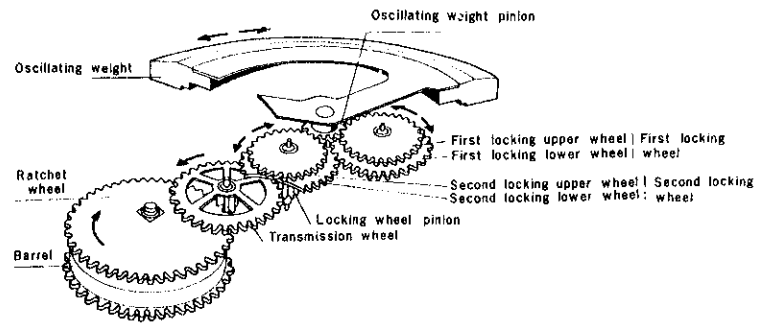

Fig. 2 Structure of Automatic Winding Gear Train

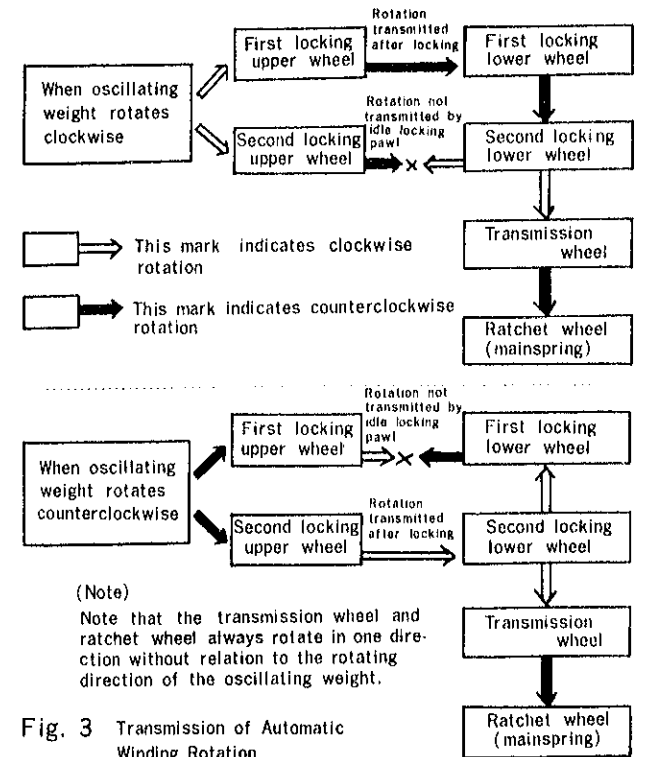
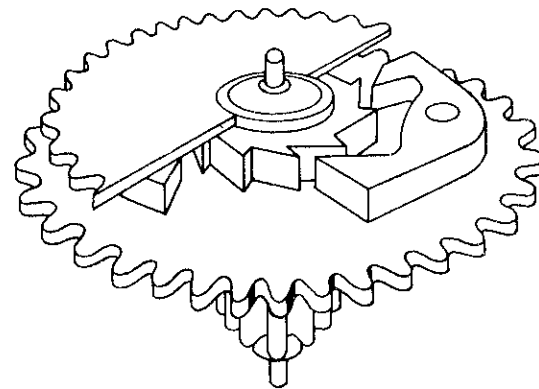

Fig. 3 Transmission of Automatic Winding Rotation

Structure of (first) locking wheel



(Note) Regarding the second locking wheel, directions of locking pawl and ratchet wheel are reversed.

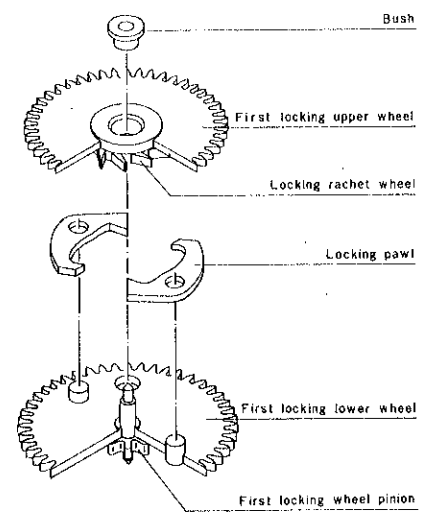

Fig. 4

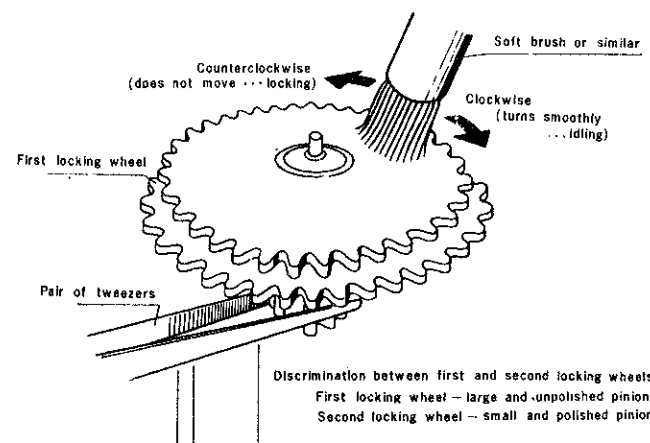

Fig. 5 Action of (First) Locking Wheel

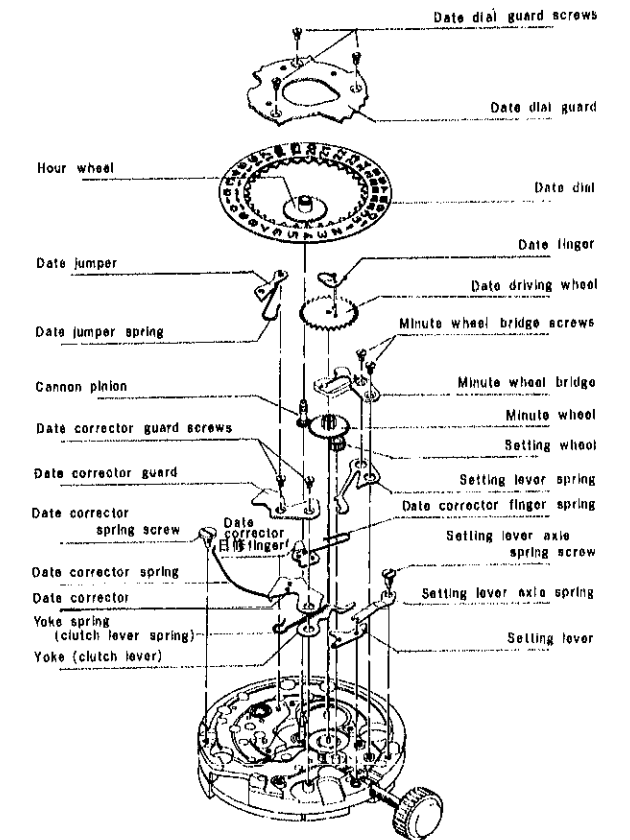

Fig. 6

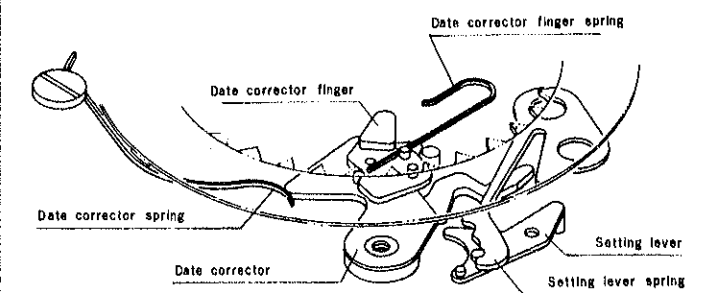

Fig. 7

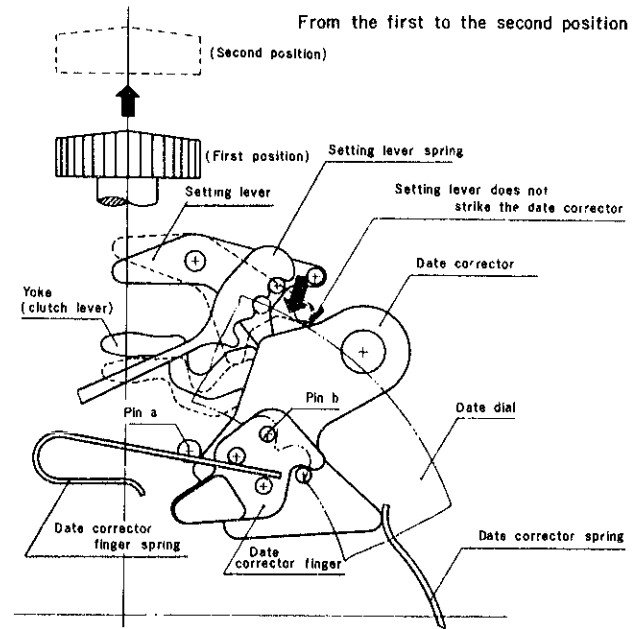

Fig. 8

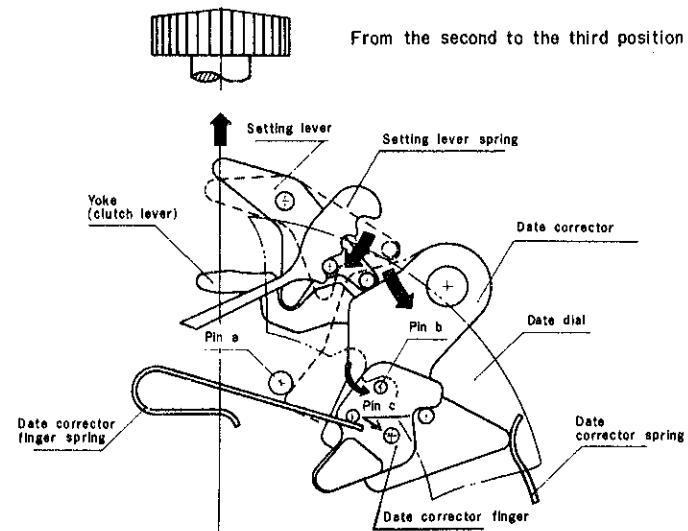

Fig. 9

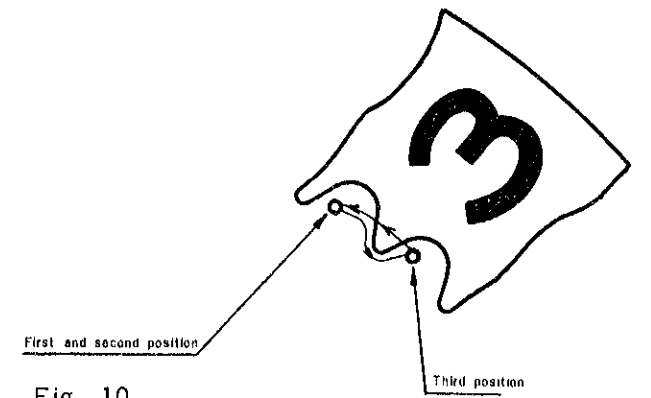

Fig. 10

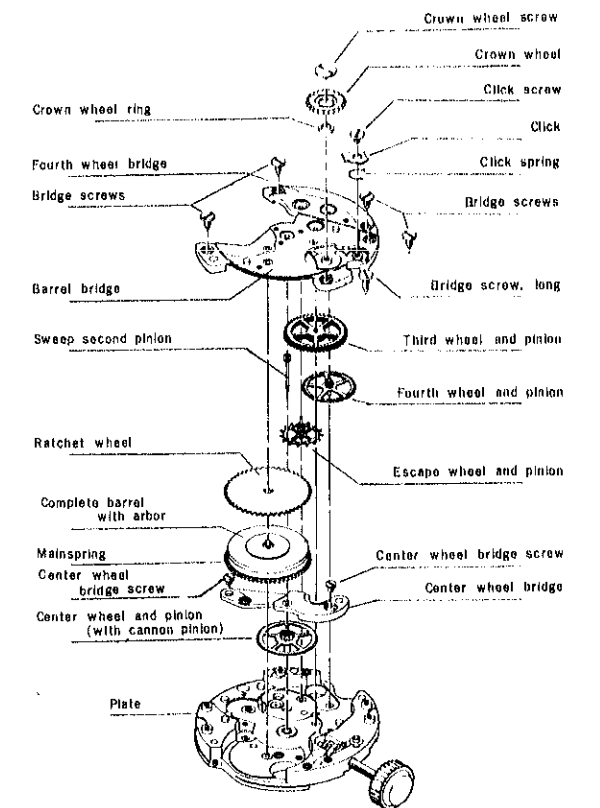
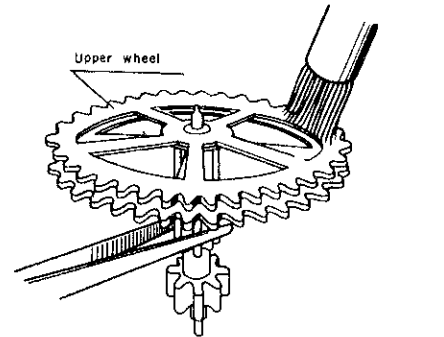
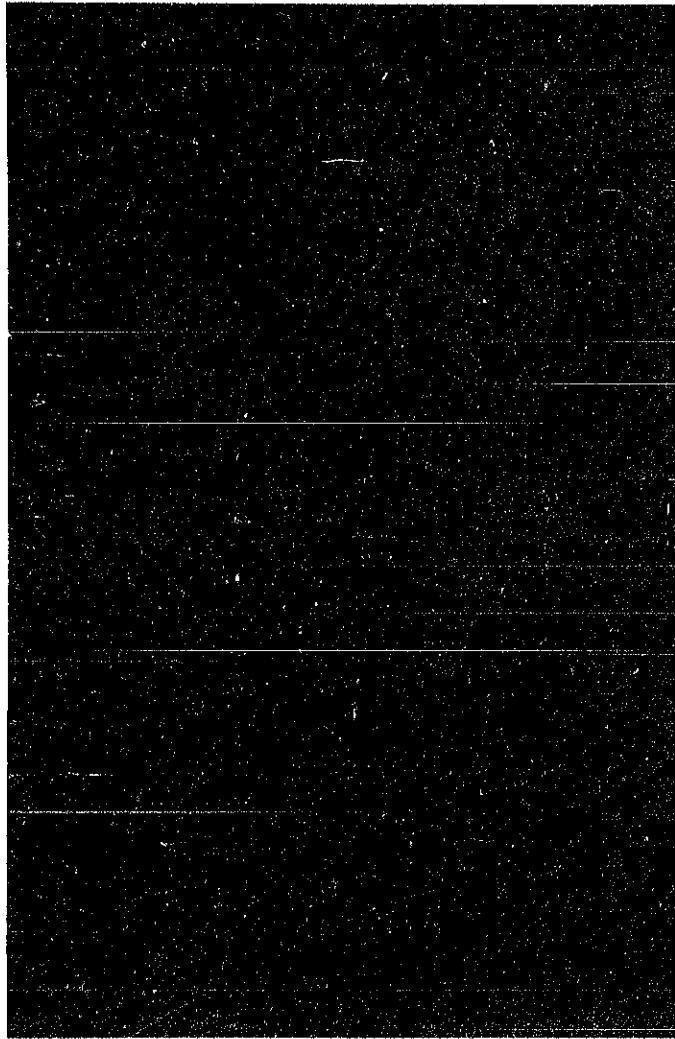
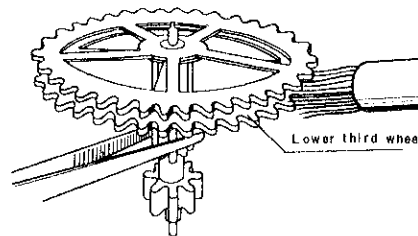

Fig. 11 Force Transmission Mechanism



Turn the upper wheel while holding the pinion with a pair of tweezers  
...Does not turn.



Turn the lower wheel while holding the pinion with a pair of tweezers  
...Turns smoothly.

Fig. 13

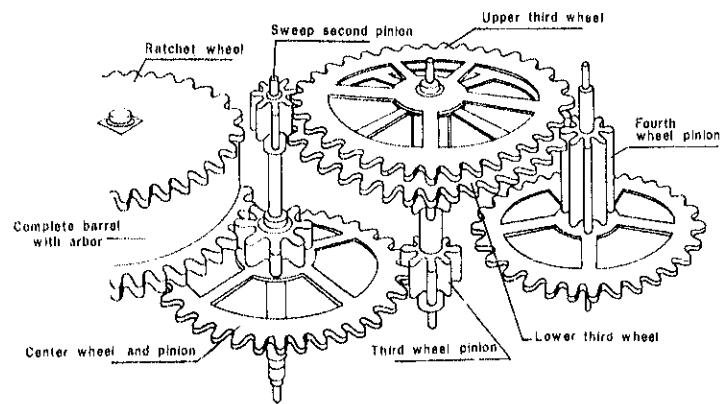

Fig. 12

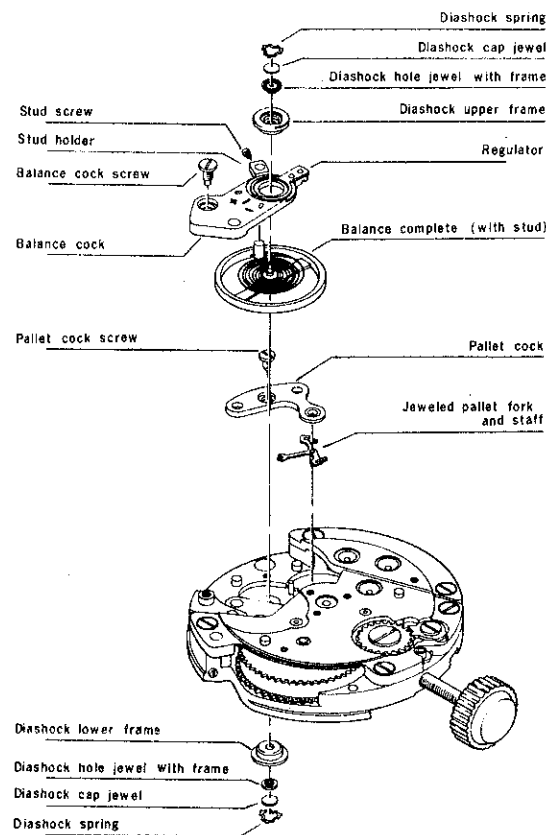
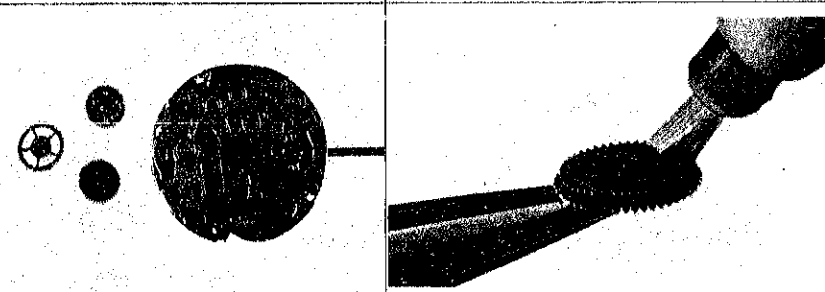

Fig. 14

	1	2
<b>Disassembly</b>	<p><b>OSCILLATING WEIGHT</b></p> <ol style="list-style-type: none"> <li>1) Remove screw for oscillating weight fork</li> <li>2) Remove oscillating weight fork</li> <li>3) Remove oscillating weight</li> </ol>	<p><b>FRAMEWORK FOR AUTOMATIC DEVICE</b></p> <ol style="list-style-type: none"> <li>1) Remove framework screws for automatic device (2 pcs)</li> <li>2) Remove framework</li> </ol>
<b>Remark</b>	<p>Check height of oscillating weight from surface of plate before removing it and confirm that oscillating weight does not touch the plate or case back. When removing oscillating weight in a condition that force of mainspring is left applied, sometimes the jewel may be broken. Disassembly should be started after teeth of the click and crown wheel are interlocked.</p>	
<b>Method</b>	<p><b>19 CONFIRMATION OF OSCILLATING WEIGHT ROTATING CONDITION</b></p> <ol style="list-style-type: none"> <li>1) Wind crown slowly after placing movement horizontally, facing oscillating weight upward</li> <li>2) Then, confirm whether or not oscillating weight rotates (escape checking); if it rotates, then escaping is defective.</li> <li>3) When mainspring is considerably wound, turn the oscillating weight by approximately 90 several times with a finger, then release oscillating weight and check reversing angle (lock checking).</li> <li>4) Fully wind and place movement vertically: rotate the movement slowly to check whether or not oscillating weight rotates together with movement. (following rotation check)</li> </ol>	
<b>Photo</b>		
<b>Method</b>	<p><b>18 OSCILLATING WEIGHT</b></p> <ol style="list-style-type: none"> <li>1) Lubricate oscillating weight axle (watch oil S-4 or Moebius grease "Remontoires")</li> <li>2) Set oscillating weight</li> <li>3) Lubricate a portion of oscillating weight fork where it contacts the oscillating weight (watch oil S-4 or Moebius grease "Remontoires")</li> <li>4) Set oscillating weight fork on framework for automatic device and fasten its screw</li> <li>5) Fasten screw for oscillating weight</li> <li>6) Check for end shake and height of oscillating weight</li> </ol>	<p><b>17 FRAMEWORK FOR AUTOMATIC DEVICE</b></p> <ol style="list-style-type: none"> <li>1) Set framework for automatic device</li> <li>2) Fasten framework screws for automatic device (2 pcs)</li> <li>3) Check end shakes of first and second locking wheel</li> <li>4) Lubricate upper pivot of transmission wheel (watch oil S-4)</li> </ol>
<b>Assembly</b>	<p>When oscillating weight rotates in case above, this indicates defective escaping of locking wheel, requiring cleaning. Reversely rotating over 90° indicates defective locking of the locking wheel, requiring replacing.</p> <p>If oscillating weight rotates together with movement, check escapement of locking wheel, and height and end shake of oscillating weight.</p>	
<b>Remark</b>	<p>Height of oscillating weight is satisfactorily positioned when the clearance with framework is between minimum 0.2mm and maximum 0.4mm.</p> <p>When tightening framework screws for automatic device, do so after confirming correct interlock of locking wheel and locking wheel pivot. Correctly lubricate upper pivot with only a small quantity of oil.</p>	

2517B Disassembly and assembly—continued

2517B Disassembly and assembly—continued

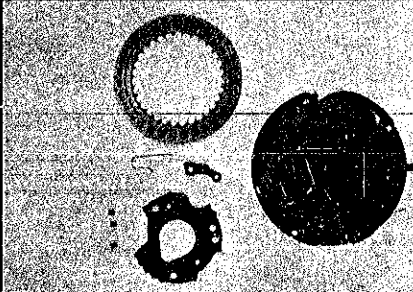
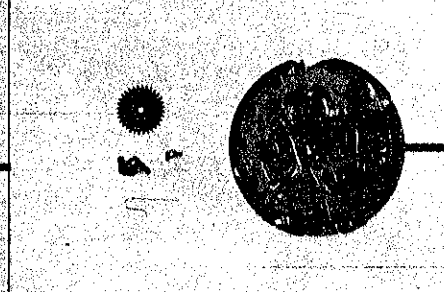
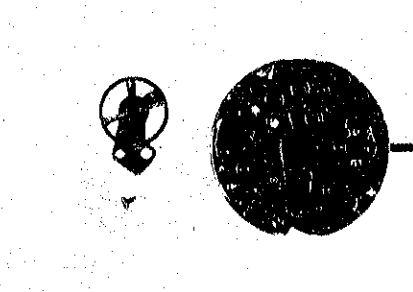

Disassembly	<b>3</b>	<b>LOCKING WHEEL AND TRANSMISSION WHEEL</b>		
	Method		1) Remove second locking wheel 2) Remove first locking wheel 3) Remove transmission wheel	
	Remark		Discriminating features of differential wheels are— Outer diameter of pinion is large and teeth are thin...First locking wheel Outer diameter of pinion is small and teeth are thick...Second locking wheel	
Photo				
Assembly	<b>16</b>	<b>LOCKING WHEEL AND TRANSMISSION WHEEL</b>		
	Method		1) Set transmission wheel 2) Lubricate upper and lower pivots of first and second locking wheels (Moebius Synt-A-Lube) 3) Set first locking wheel 4) Set second locking wheel	
	Remark		Set second locking wheel on the nearer portion to transmission wheel.	
	<b>15</b>	<b>CHECK OF LOCKING WHEEL</b>		
Method		Check escaping and locking conditions of locking wheel by turning it with a very soft paint brush while holding the locking wheel pinion with tweezers.		
Remark		As shown in above photo, when checking escape of locking wheel, turn locking upper wheel in escape direction with a small paint brush while holding pinion with tweezers. If rotation is sluggish, escape is defective. Concerning the direction of escape, first locking wheel is right rotation (clockwise) and second locking wheel is left rotation (counterclockwise). (For the locking test, turn locking wheel in reverse direction. If it turns reversely above 45°, this is defective locking.)		
	<b>14</b>	<b>LUBRICATION</b>		
Method		Refer to p. 2517-14		

Disassembly	<b>4</b>	<b>DATE DIAL GUARD DATE JUMPER</b>	<b>5</b>	<b>DATE DRIVING WHEEL (WITH DATE FINGER &amp; SPRING)</b>	<b>6</b>	<b>BALANCE COCK</b>	
	Method		1) Remove date dial guard screws (3 pcs) 2) Remove date dial guard 3) Remove date jumper 4) Remove date dial 5) Remove date jumper spring		1) Unwind mainspring 2) Remove balance cock screw 3) Remove balance cock		
	Remark		When removing date dial, pay attention to date jumper spring because it easily leaps off.		When detaching date finger spring, pay attention to avoid bending the spring welded portion while holding it up. Also handle the date corrector finger spring carefully because it springs up easily. Since the date jumper spring and date corrector finger spring are similar size and shaped, previously confirm their shapes.		Before removing balance cock, confirm state of playing of hairspring between regulator key stud and pin portion to be realized while assembling. When removing the balance cock with balance, be careful not to deform shape of hairspring.
Photo							
Assembly	<b>13</b>	<b>DATE DIAL GUARD DATE JUMPER</b>	<b>12</b>	<b>DATE DRIVING WHEEL DATE CORRECTOR FINGER</b>	<b>11</b>	<b>BALANCE COCK</b>	
	Method		1) Set date jumper spring 2) Set date dial 3) Set date jumper 4) Set date dial guard 5) Fasten date dial guard screws (3 pcs) 6) Lubricate on the side cannon pinion (watch oil S-4 or Moebius grease "Remontoires") 7) Set hour wheel 8) Make test run of date dial (5 rotations) 9) Check for date driving and date correcting conditions		1) Set date corrector finger 2) Set date corrector finger spring 3) Lubricate tube for date driving wheel screw (Moebius Synt-A-Lube) 4) Set date driving wheel 5) Set date finger		1) Set balance cock with balance 2) Fasten balance cock screw 3) Check for proper end shake of balance 4) Check for state of hairspring and action of escapement 5) Adjust height of stud head
	Remark		Inspect for dust on date dial guard and date dial guide portion of plate. When change of date dial is defective, apply a small quantity of Moebius Synt-A-Lube to contacting side surface of date jumper. Never allow height of date dial guard screw to project above date dial guard.		Correctly insert date corrector finger spring into recessed portion of minute wheel bridge; further, make sure not to confuse with date jumper spring. Carefully assemble date finger to prevent deforming it.		Do not change the condition of hairspring and shape of hairspring.

2517B Disassembly and assembly—continued

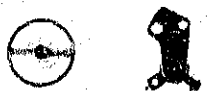
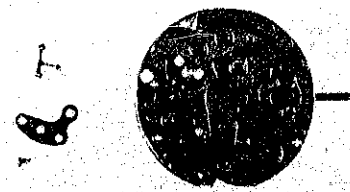
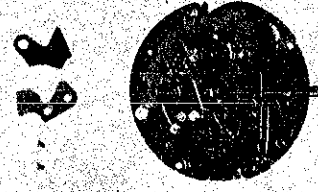
2517B Disassembly and assembly—continued

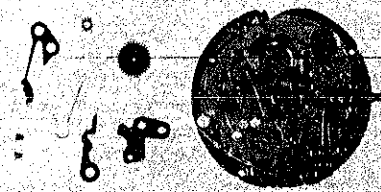
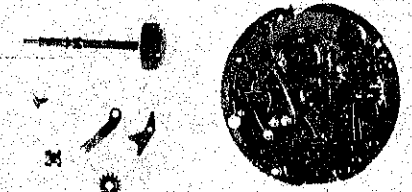
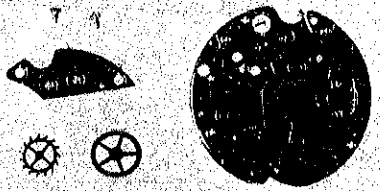
Disassembly	<b>7</b>	<b>BALANCE</b>	<b>8</b>	<b>JEWELLED PALLET FORK &amp; STAFF</b>	<b>9</b>	<b>DATE CORRECTOR</b>
	<ol style="list-style-type: none"> <li>1) Remove stud after loosening stud screw</li> <li>2) Remove balance by turning regulator key with driver</li> </ol>		<ol style="list-style-type: none"> <li>1) Remove pallet cock screw</li> <li>2) Remove pallet cock</li> <li>3) Remove pallet</li> </ol>		<ol style="list-style-type: none"> <li>1) Remove date corrector guard screws (2 pcs)</li> <li>2) Remove date corrector guard</li> <li>3) Remove date corrector</li> </ol>	
	Pay attention not to deform shape of hairspring.				Do not remove date corrector spring and date corrector spring screw.	
Photo						
Assembly	<b>10</b>	<b>BALANCE</b>	<b>9</b>	<b>JEWELLED PALLET FORK &amp; STAFF</b>	<b>8</b>	<b>DATE CORRECTOR</b>
	<ol style="list-style-type: none"> <li>1) Check shape of hairspring</li> <li>2) Place balance on balance cock</li> <li>3) Insert hairspring between regulator key and regulator pin, and insert stud into stud holder</li> <li>4) Turn regulator key</li> <li>5) Fasten stud screw</li> </ol>		<ol style="list-style-type: none"> <li>1) Lubricate jeweled pallet fork (Moebius Synt-A-Lube)</li> <li>2) Set pallet and cock</li> <li>3) Fasten pallet cock screw</li> <li>4) Lubricate pallet upper and lower pivots</li> <li>5) Confirm engaging degree of pallet jewel</li> </ol>		<ol style="list-style-type: none"> <li>1) Set date corrector</li> <li>2) Set date corrector guard</li> <li>3) Fasten date corrector guard screws (2 pcs)</li> <li>4) Check for date corrector end shake and its action</li> </ol>	
	When inserting stud into stud holder and inserting hairspring between regulator key and regulator pin, make sure not to deform shape of hairspring.		Engagement of jeweled pallet fork should be 1/4-1/5 of jewel width for the first lock and approximately 1/2 of the first lock quantity for the second lock.		When date corrector shows defective action, sometimes it is due to improper lubrication of setting lever, so carefully check it.	

Disassembly	<b>10</b>	<b>YOKE (CLUTCH LEVER) AND MINUTE WHEEL</b>	<b>11</b>	<b>WINDING STEM AND SETTING LEVER</b>	<b>12</b>	<b>FOURTH WHEEL BRIDGE</b>
	<ol style="list-style-type: none"> <li>1) Remove minute wheel bridge screw (2 pcs)</li> <li>2) Remove minute wheel bridge</li> <li>3) Remove setting lever spring</li> <li>4) Remove minute wheel and setting wheel</li> <li>5) Remove yoke spring (clutch lever spring) and yoke (clutch lever)</li> </ol>		<ol style="list-style-type: none"> <li>1) Remove setting lever axle spring screw</li> <li>2) Remove setting lever axle spring</li> <li>3) Remove setting lever</li> <li>4) Remove winding stem</li> <li>5) Remove clutch wheel and winding wheel</li> </ol>		<ol style="list-style-type: none"> <li>1) Remove fourth wheel bridge screws (2 pcs)</li> <li>2) Remove fourth wheel bridge</li> <li>3) Remove fourth wheel and pinion</li> <li>4) Remove escape wheel and pinion</li> </ol>	
	Be careful not to deform yoke spring.					
Photo						
Assembly	<b>7</b>	<b>YOKE (CLUTCH LEVER) AND MINUTE WHEEL</b>	<b>6</b>	<b>WINDING STEM AND SETTING LEVER</b>	<b>5</b>	<b>FOURTH WHEEL BRIDGE</b>
	<ol style="list-style-type: none"> <li>1) Set yoke, clutch lever spring</li> <li>2) Set setting wheel and minute wheel</li> <li>3) Set setting lever spring</li> <li>4) Set minute wheel bridge</li> <li>5) Fasten minute wheel bridge screw (2 pcs)</li> <li>6) Check for end shake of minute wheel and conditions of crown extracting and depressing</li> <li>7) Check for conditions of free running and hand setting</li> </ol>		<ol style="list-style-type: none"> <li>1) Set winding wheel and clutch wheel</li> <li>2) Set winding stem after lubricating it (watch oil S-4 or Moebius grease "Remontoires")</li> <li>3) Set setting lever</li> <li>4) Set setting lever axle spring</li> <li>5) Fasten setting lever axle spring screw</li> <li>6) Lubricate tube for yoke, setting lever, winding wheel, clutch wheel, setting wheel, and tube for minute wheel pin (watch oil S-4 or Moebius grease "Remontoires")</li> </ol>		<ol style="list-style-type: none"> <li>1) Set escape wheel and pinion after lubricating upper and lower pivots (Moebius Synt-A-Lube)</li> <li>2) Set fourth wheel and pinion after lubricating upper and lower pivots (Moebius Synt-A-Lube)</li> <li>3) Set fourth wheel bridge</li> <li>4) Fasten fourth wheel bridge screws (2 pcs)</li> <li>5) Check for end shake and rotating condition of each wheel</li> </ol>	
	Do not adjust to heavy hand setting (make the turn smoothly by suitable pinion folding)		Lubricating portions of setting lever are as follows.		When rotating condition is not smooth on any wheel, recheck for oil quantity and end shake.	
Remark						



	13 BARREL BRIDGE	14 TRAIN-WHEEL BRIDGE	15 CROWN WHEEL
<b>Disassembly Method</b>	<ol style="list-style-type: none"> <li>Remove barrel bridge screws (2 pcs) and bridge screw, long (1 pce.)</li> <li>Remove barrel bridge</li> <li>Remove setting lever axle</li> <li>Remove ratchet wheel</li> <li>Remove complete barrel with arbor</li> <li>Remove third wheel and pinion</li> <li>Remove sweep second pinion</li> </ol>	<ol style="list-style-type: none"> <li>Remove cannon pinion</li> <li>Center wheel bridge screw (2 pcs)</li> <li>Remove center wheel bridge</li> <li>Remove center wheel and pinion</li> </ol>	<ol style="list-style-type: none"> <li>Remove crown wheel screw</li> <li>Remove crown wheel Remove crown wheel ring</li> </ol>
<b>Remark</b>	It is not necessary to remove oscillating weight axle.	Pull out cannon pinion vertically. If it is pulled out on an inclined position, occasionally the center wheel arbor may bend or break.	Crown wheel screw is a left-handed screw. Do not remove click.
<b>Photo</b>			
	4 BARREL BRIDGE	3 TRAIN-WHEEL BRIDGE	2 CROWN WHEEL
<b>Assembly Method</b>	<ol style="list-style-type: none"> <li>Lubricate sweep second pinion and set it (Moebius Synt-A-Lube)</li> <li>Set third wheel and pinion after lubricating upper and lower pivots (watch oil S-4)</li> <li>Set complete barrel with arbor after lubricating upper and lower pivots (watch oil S-4 or Moebius grease "Remontoires")</li> <li>Set ratchet wheel</li> <li>Set setting lever axle</li> <li>Set barrel bridge</li> <li>Tighten barrel bridge screws (3 pcs); one is long screw</li> <li>Check for end shake and inspect rotating condition of each wheel</li> </ol>	<ol style="list-style-type: none"> <li>Set center wheel and pinion after lubricating upper and lower pivots</li> <li>Set center wheel bridge</li> <li>Tighten center wheel bridge screw (2 pcs)</li> <li>Turn over movement and lubricate on lower stem</li> <li>Push in cannon pinion</li> <li>Check for end shake of center wheel and pinion</li> <li>Lubricate the lower hole jewel of transmission wheel</li> </ol>	<ol style="list-style-type: none"> <li>Set crown wheel ring</li> <li>Lubricate on the side of crown wheel ring (watch oil S-4 or Moebius grease "Remontoires")</li> <li>Set crown wheel</li> <li>Tighten crown wheel screw</li> <li>Confirm rotating condition of crown wheel</li> </ol>
<b>Remark</b>	Before tightening bridge screws, confirm rotating condition of each wheel.	Push in cannon pinion vertically. Initially perform lubrication of transmission wheel lower pivot, because this becomes impossible after completing assembly. Lubricate them. (watch oil S-4)	

	16 DIASHOCK
<b>Disassembly Method</b>	<ol style="list-style-type: none"> <li>Detach Diashock spring</li> <li>Remove hole jewel with frame left attaching cap jewel</li> </ol>
<b>Remark</b>	
<b>Photo</b>	
	1 DIASHOCK
<b>Assembly Method</b>	<ol style="list-style-type: none"> <li>Place cap jewel with flat surface upward</li> <li>Put drop of oil on its center, holding cap jewel with tweezers</li> <li>Set Diashock hole jewel with frame over oiled cap jewel</li> </ol>
<b>Remark</b>	

Identification of locking wheel and lubrication method

There are three types of I, II and III locking wheels used in the 25-series automatic watch, the lubrication method different for each type. When repairing watches, the type must be correctly identified to perform appropriate lubrication.

Type Item	I	II	III
<b>Rear-view Shape</b>	<p>Moebius Synt-A-Lube</p> <p>○Tip of pawl visible through viewing hole</p> <p>○Pivot diameter smaller than type II locking wheel</p>	<p>Moebius Synt-A-Lube</p> <p>○Tip of pawl visible through viewing hole</p> <p>○Pivot diameter larger than type I locking wheel</p>	<p>○Pawl not visible through viewing hole</p>
<b>Lubrication method</b>	Lubricate ratchet of locking wheel by inserting an oiling stick through pawl viewing hole. (small quantity of Moebius Synt-A-Lube)		<b>Lubrication unnecessary</b>
<b>Parts number of</b>	First locking wheel, 667031	First locking wheel, 667032	First locking wheel, 667250
<b>Locking wheel correspond</b>	Second locking wheel, 668031	Second locking wheel, 668032	Second locking wheel, 668250

Table 1 Identification of Locking Wheel and Lubrication Method