

SEIKO

QUARTZ

Cal. 2633A

PARTS LIST

Cal. 2633A

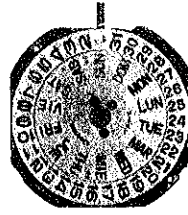
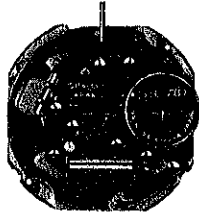

131 264



231 260



☆241 260



261 260



☆270 260



☆271 269



281 260



282 260



☆354 260



☆354 262



372 261



373 250



383 260



384 260



389 260



391 260



☆397 263



436 260



☆470 095



491 180



495 260



499 260



556 260



560 260



701 260



706 260



719 260



☆801 262



802 260



808 260



810 260



817 260



868 260

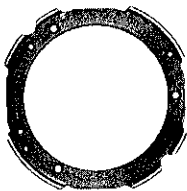

☆884 262



963 260



☆4001 260



☆4002 261



4146 260



4216 261



4219 260



4239 260



4242 261



4270 260



4455 260



011 409

☆SEIKO SB-AP



012 151



012 159



012 452



012 768



012 770



012 781



017 125



017 126



017 127



017 128



017 129



017 130



017 131



017 936

2/1

Cal. 2633A

Characteristics:

Casing diameter: ϕ 25.40 mm
 Maximum height: 3.56 mm without battery
 Jewels: 2 j
 Frequency of quartz crystal oscillator: 32,768 Hz (Hz=Hertz Cycle per second)
 Driving system: Step motor system (2 poles)
 Regulation system: Trimmer condenser
 Second setting device
 Calendar (day & date)
 Instant setting device for day & date calendar
 Bilingual change-over system for day of the week
 Battery life indicator: Second hand moves in two-second interval.

PART NO.	PART NAME	PART NO.	PART NAME
131 264	Third wheel bridge	☆4001 260	Circuit block
231 260	Third wheel & pinion	(☆4001 270)	
☆241 260	Fourth wheel & pinion (4.54 mm)	☆4002 261	Coil block
☆241 264	Fourth wheel & pinion (4.81 mm)	4146 260	Step rotor
261 260	Minute wheel	4216 261	Insulator for battery
☆270 260	Center minute wheel with cannon pinion (2.58 mm)	4219 260	Insulator for battery connection
☆270 264	Center minute wheel with cannon pinion (2.85 mm)	4239 260	Rotor stator
☆271 269	Hour wheel (1.69 mm)	4242 261	Plus terminal of battery connection
☆271 270	Hour wheel (1.91 mm)	4270 260	Battery connection
281 260	Setting wheel	4455 260	Reset lever
282 260	Clutch wheel	011 409	Upper hole jewel for step rotor
☆354 260	Winding stem (13.85 mm)	011 409	Lower hole jewel for step rotor
☆354 262	Winding stem (19.55 mm)	012 151	Third wheel bridge screw
372 261	Joint stem (Movement portion)	012 151	Circuit block screw A
373 250	Joint stem (Case portion)	012 151	Coil block screw (Screw for plus terminal of battery connection)
383 260	Setting lever	012 159	Circuit block screw B
384 260	Yoke (Clutch lever)	012 452	Case screw
389 260	Setting lever axle spring	012 768	Setting lever axle spring screw
391 260	Second setting lever	012 768	Holding ring screw for dial
☆397 263	Lever for unlocking stem	012 770	Date driving wheel screw
436 260	Lower end-piece for third wheel	012 781	Date dial guard with day corrector screw
☆470 095	Day star with dial disk	017 125	Tube for circuit block A
491 180	Dial washer	017 126	Tube for circuit block B
495 260	Spacer for third wheel bridge	017 127	Tube for circuit block C
499 260	Day finger ring	017 128	Second setting lever pin
556 260	Date finger	017 129	Tube for third wheel bridge screw A
560 260	Friction spring for fourth wheel and pinion	017 130	Tube for third wheel bridge screw B
701 260	Fifth wheel & pinion	017 131	Tube for coil block screw
706 260	Sixth wheel & pinion	017 936	Eccentric dial pin
719 260	Day corrector	☆SEIKO SB-AP	Silver oxide battery
☆801 093	Date dial	☆Maxell SR926SW	Silver oxide battery
☆801 094			
☆801 095			
☆801 096			
☆801 262			
☆801 266			
802 260	Date driving wheel		
808 260	Date dial guard (with day corrector)		
810 260	Date jumper		
817 260	Intermediate date wheel		
868 260	Day finger		
☆884 262	Holding ring for dial		
963 260	Snap for day star with dial disk		





☆ Please see remarks on the reverse page.
 Part numbers in light letters are not shown in photos.

Cal. 2633A

Remarks:

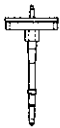
Fourth wheel and pinion, Center minute wheel with cannon pinion and Hour wheel

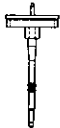
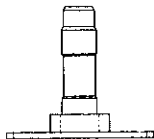
Combination:

Type	Fourth wheel and pinion	Center minute wheel with cannon pinion	Hour wheel
a			
	☆241 260	☆270 260	☆271 269
b			
	☆241 264	☆270 264	☆271 270

Winding stem.....Refer to the photograph on the front page.

☆354 260.....Short winding stem (Thread is provided completely on the crown portion.)

☆354 262.....Long winding stem (Thread is provided only on the end of the crown portion.)

If the combination of the winding stem and case is unknown, check the case number and refer to "SEIKO Quartz Casing Parts List" to choose a corresponding winding stem.

Lever for unlocking stem

☆397 263.....When adjusting the length of the lever for unlocking stem by cutting its tail, be sure that the tail partly comes out of the brim of the dial as shown in the illustration.

If the tail is hidden from view by the dial, it will be difficult to disassemble the winding stem.

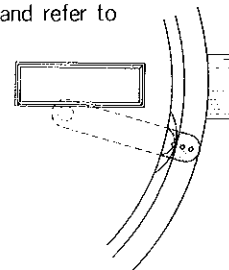

Day star with dial disk

☆470 095(English↔Spanish, black figures on white background).....Used when both the crown and the calendar frame are located at **3** o'clock position.

If any other type of day star with dial disk is required, specify the number printed on the disk.

Date dial

☆801 093(White figures on black background)
 ☆801 094(Black figures on gold background)
 ☆801 262(Black figures on white background) } Used when both the crown and the calendar frame are located at **3** o'clock position.

☆801 095(White figures on black background)
 ☆801 096(Black figures on gold background)
 ☆801 266(Black figures on white background) } Used when the crown are located at **3** o'clock and the calendar frame at **6** o'clock position.

If any other type of date dial is required, specify ① Cal. No. ② Jewels ③ The crown position ④ The calendar frame position and ⑤ Dial No.

Holding ring for dial

The type of a holding ring for dial is determined based on the design of cases and dials. If the shape of holding ring for dial is different from the photograph, check the case number and refer to "SEIKO Quartz Casing Parts List" to choose a corresponding holding ring for dial.

Circuit block ☆4001 260(4001 270).....4001 270 can be used as 4001 260.

Coil block ☆4002 261.....The parts that have the same parts No. as 4002 261 are interchangeable, even if the color of that parts is different.

Battery

☆SEIKO SB-AP }The applied battery for this calibre might be added the substitutive in the future. In that case, please refer to separate "BATTERIES FOR SEIKO QUARTZ WATCHES".
 ☆Maxell SR926SW }

TECHNICAL GUIDE

SEIKO

QUARTZ

CAL. 2633A

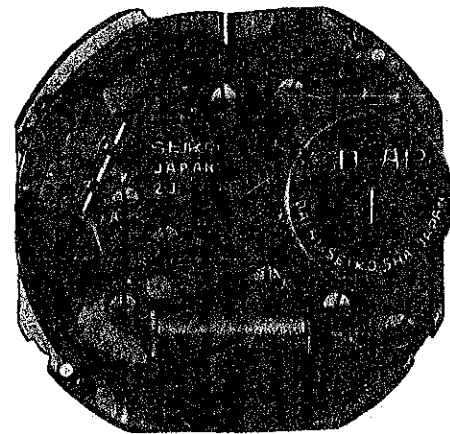
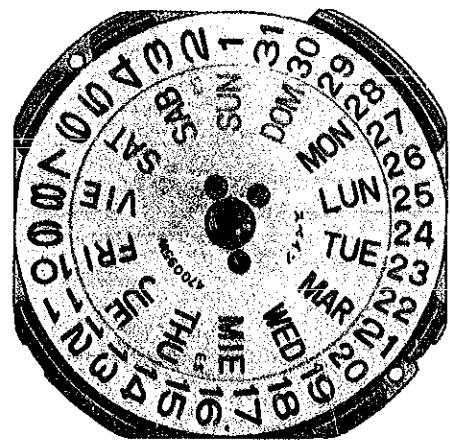

CONTENTS

I. SPECIFICATIONS	1
II. DISASSEMBLING, REASSEMBLING AND LUBRICATING	2
(1) Calendar and setting mechanism	2
(2) Electronic circuit and gear train mechanism	4
III. CHECKING AND ADJUSTMENT	6
(1) Guide table for checking and adjustment	6
(2) Procedures for checking and adjustment	7
A: Check output signal	7
B: Check battery voltage	7
C: Check battery conductivity	7
D: Check circuit block conductivity	7
E: Check reset and second setting conditions	8
F: Check coil block	9
G: Check output signal	9
H: Check accuracy	9
I: Check battery life indicator	9
J: Check current consumption	9

SEIKO QUARTZ Cal. 26 SERIES

SEIKO Quartz Cal. 26 series are the compact, thin and multifunctional quartz crystal analogue watches with a wide choice of styles both for men and ladies.

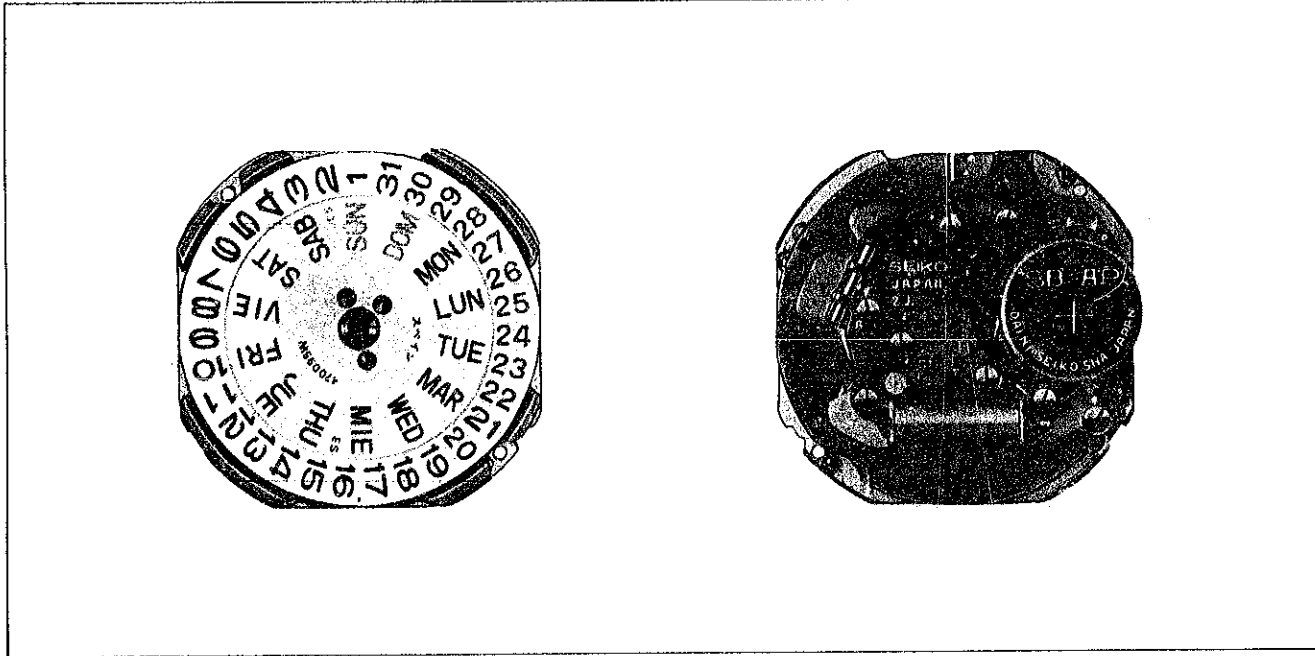

I. SPECIFICATIONS

Cal. No.		2620 A	2622 A	2623 A	2633 A	2639 A
Item						
Time indication		2 hands	3 hands	3 hands	3 hands	2 hands
Additional mechanism	Date	—	○	○	○	○
	Day	—	—	○	○	—
	Bilingual change-over system for the day of the week	—	—	○	○	—
	Instant day setting device	—	—	○	○	—
	Instant date setting device	—	○	○	○	○
	Second setting device (Stops at every second)	—	○	○	○	—
	Battery life indicator	—	○	○	○	—
	Electronic circuit reset switch	○	○	○	○	○
Crystal oscillator	32,768 Hz (Hz = Hertz . . . Cycle per second)					
Loss/gain	Loss/gain at normal temperature Monthly rate: less than 15 seconds (Annual rate: less than 3 minutes)					
Casing diameter	φ17.6mm (16.00mm between 3 o'clock and 9 o'clock sides)			φ25.4mm (23.4mm between 3 o'clock and 9 o'clock, 6 o'clock and 12 o'clock sides)		
Height (excluding battery portion)	3.0mm	3.2mm	3.5mm		3.2mm	
Operational temperature range	-10°C ~ +60°C (14°F ~ 140°F)					
Driving system	Step motor system (2 poles)					
Regulation system	Trimmer condenser					
Battery power	SEIKO SB-DL • Battery life: Approx. two years • Voltage: 1.55V Maxell SR726SW • Battery life: Approx. one year • Voltage: 1.55V	SEIKO SB-D1 • Battery life: Approx. three years • Voltage: 1.55V U.C.C. 384, 392 or Maxell SR-41SW • Battery life: Approx. two years • Voltage: 1.55V		SEIKO SB-AP Maxell SR926SW • Battery life: Approx. tow years • Voltage: 1.55V		
Jewel	2 jewels					

II. DISASSEMBLING, REASSEMBLING AND LUBRICATING (Cal. 2633A)

Disassembling and reassembling

Disassembling procedures Figs. ① ~ ⑤⑩
 Reassembling procedures Figs. ⑤⑩ ~ ①

Lubricating

Types of oil
 ● Moebius A
 ○ SEIKO Watch Oil S-6

Oil quantity
 ● Liberal
 ● Normal
 ● Extremely small

(1) Calendar and setting mechanism

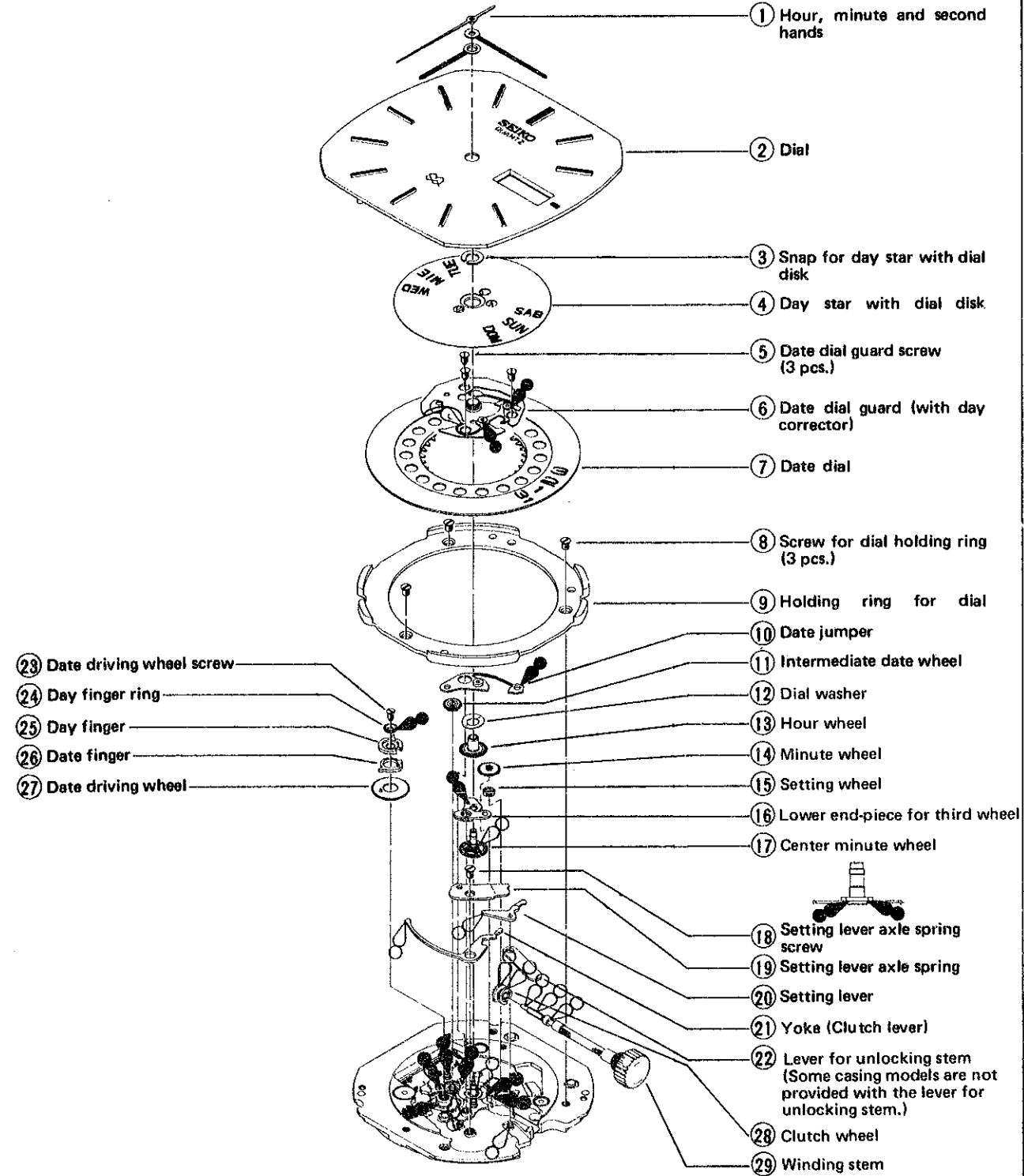

Remarks for disassembling and reassembling

- How to disassemble and reassemble the hands ①
 When disassembling or reassembling, always pull the crown out to the second click position. The second hand must be placed just in line with a second mark. (Either odd or even second mark will do.)
- How to disassemble and reassemble the dial ②
 After turning the eccentric dial pin between 90° and 150°, it is possible to remove and replace the dial.

How to turn the eccentric dial pin

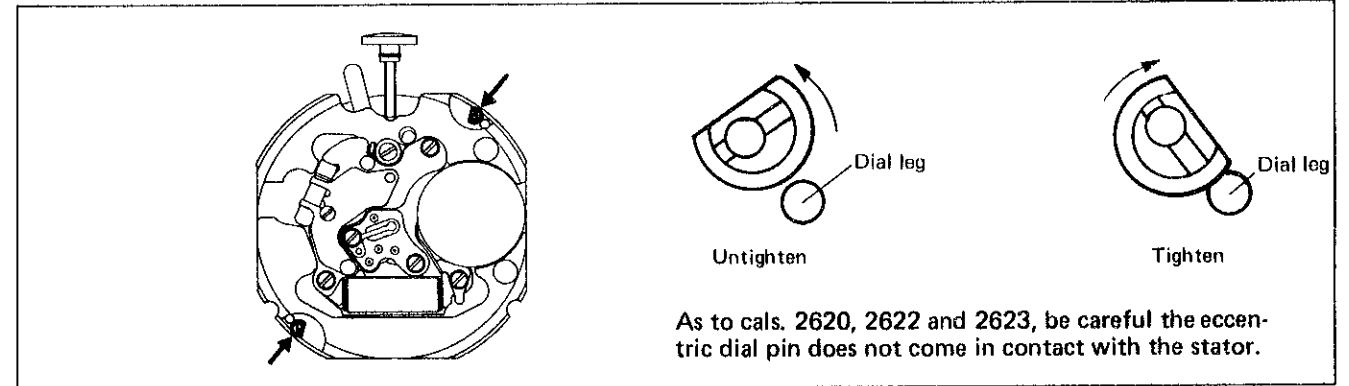

• Date dial guard ⑥

Handle the day corrector together with the date dial guard except when its replacement is required.

• How to reassemble the day corrector

1. Hook the day corrector on the pins for the date dial guard in the order of A and B.
2. Place the day corrector spring portion C (arrow-marked) under the backside of the date dial guard.

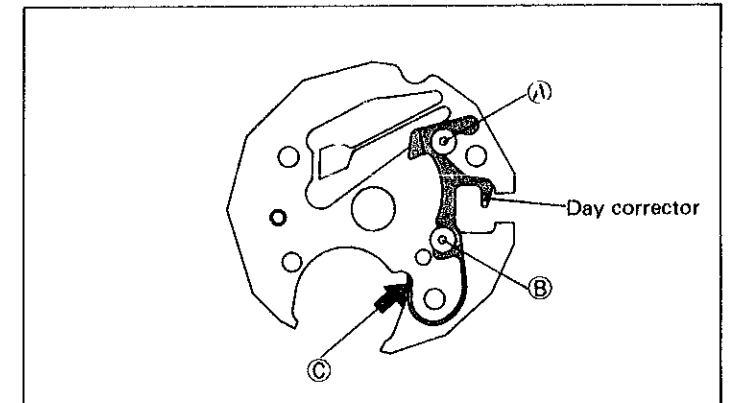

• How to reassemble the date finger and the day finger ②⑤, ②⑥

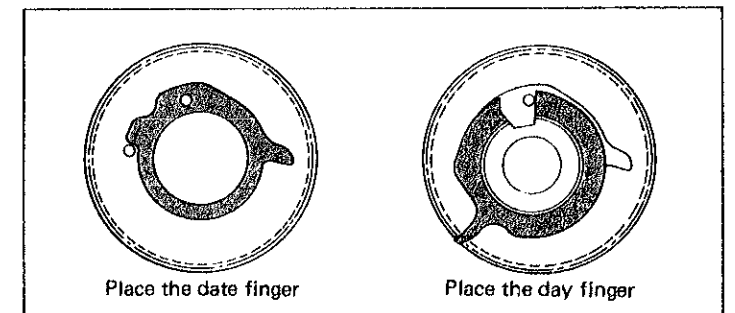

• How to remove the winding stem ②⑨

• From the circuit block side

A part of the setting lever is seen in the hole of the main plate (arrow-marked) in the second click position of the crown. Push it down to remove the winding stem.

• From the dial side

A part of the lever for unlocking stem is seen at the outer circumference of the dial. Push it down to remove the winding stem.

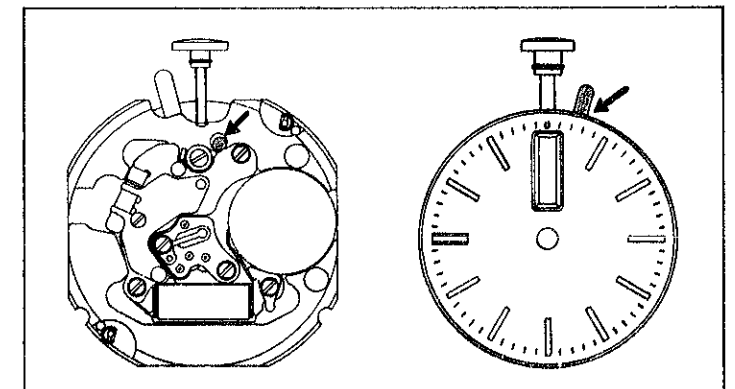

(2) Electronic circuit and gear train mechanism

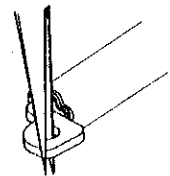

How to hold the coil block

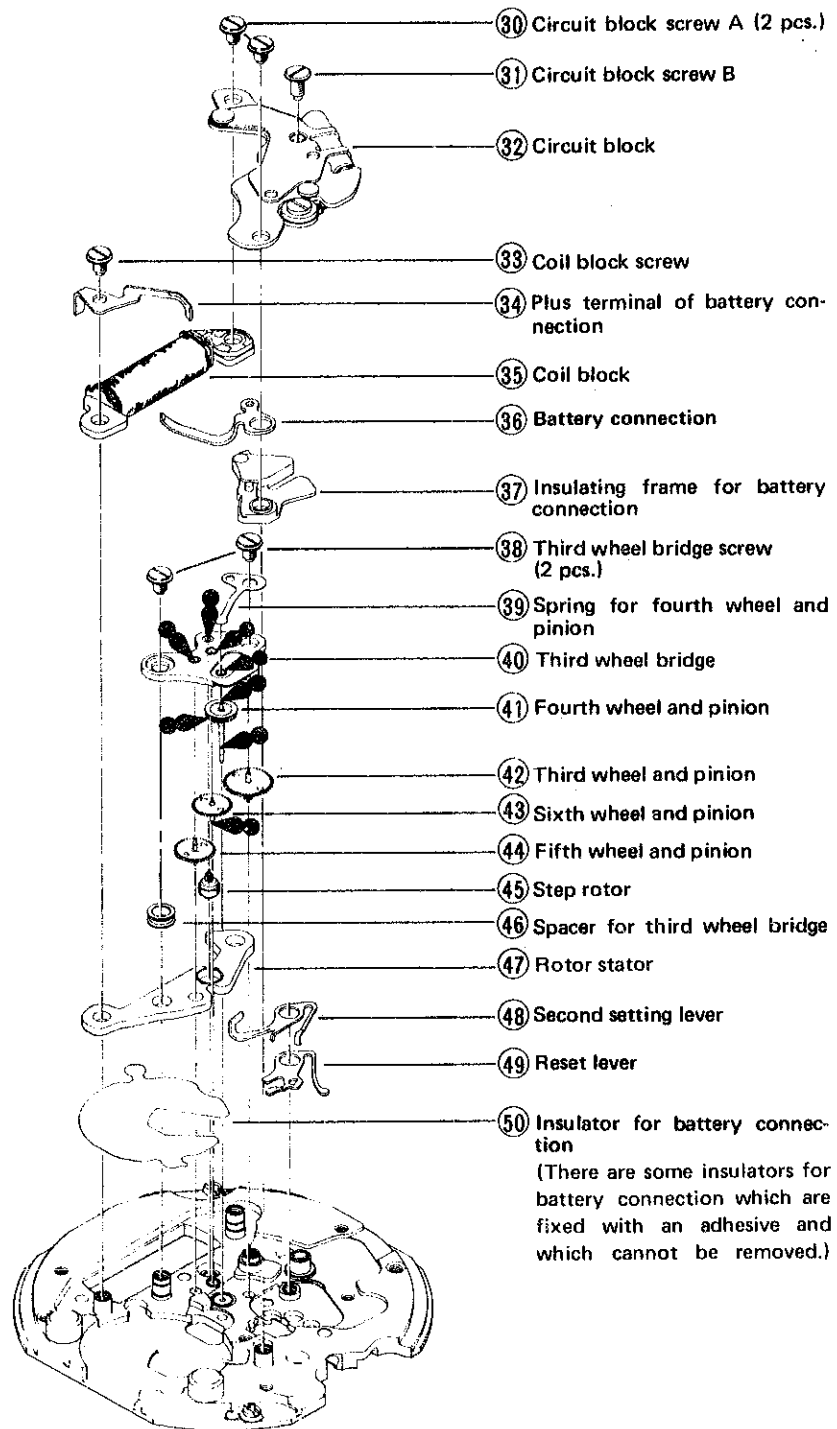

(Difference between Cal. 2633A and other 26 series in disassembling and reassembling)

1) The calendar setting mechanism
 Cal. 2620 . . . The parts of ③ ~ ⑪ and ⑳ ~ ㉓ are not used. But the minute wheel bridge is used.
 Cal. 2622, 2639 . . . The parts of ③ ④ and ⑳ ~ ㉓ are not used. These calibres do not use the day star with dial disk and therefore the date dial guard is not fitted with the day corrector. These calibres are not provided with the dial washer.

2) Electronic circuit and gear train mechanism
 Cal. 2620, 2639 . . . The spring for fourth wheel and pinion is not used. See the Parts Catalogue for the detailed difference of parts.

• How to reassemble the gear train, reset lever and second setting lever ④1 ~ ④9

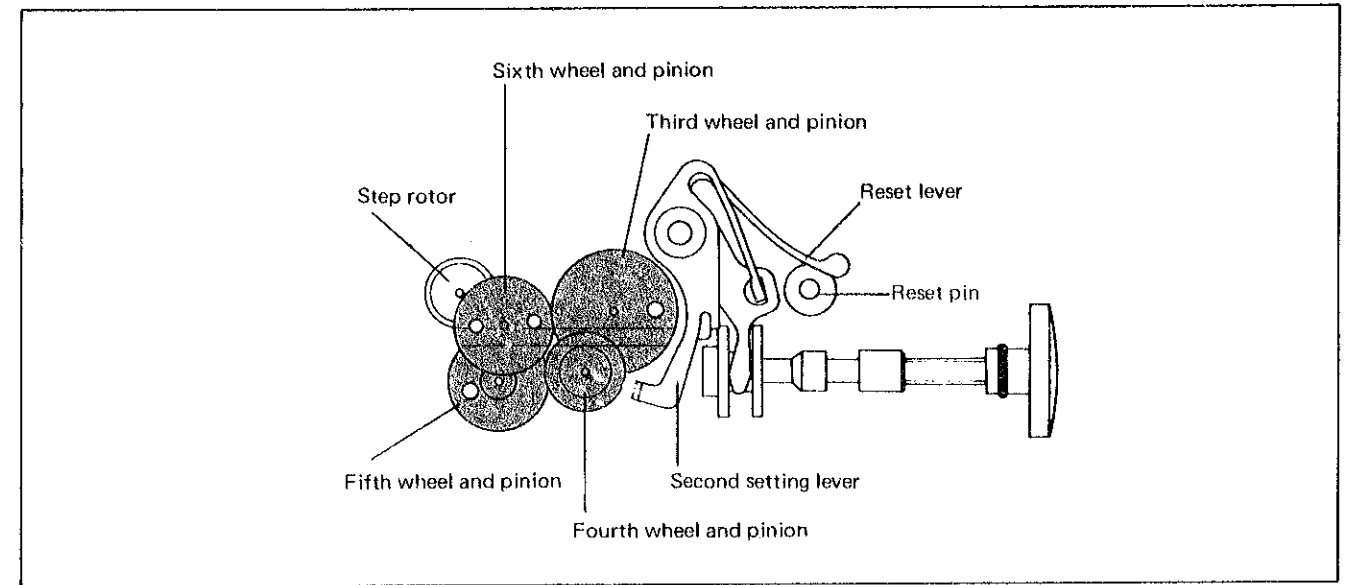

• Functions of the gear train, reset lever and second setting lever ④1 ~ ④9

• When the crown is pulled out to the second click position, make sure that the second setting lever sets securely the fourth wheel and pinion and at the same time the reset lever touches the reset pin.

• Normal and first click positions of the crown

• Second click position of the crown

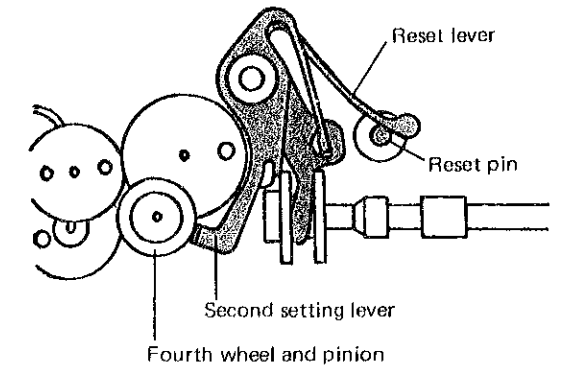
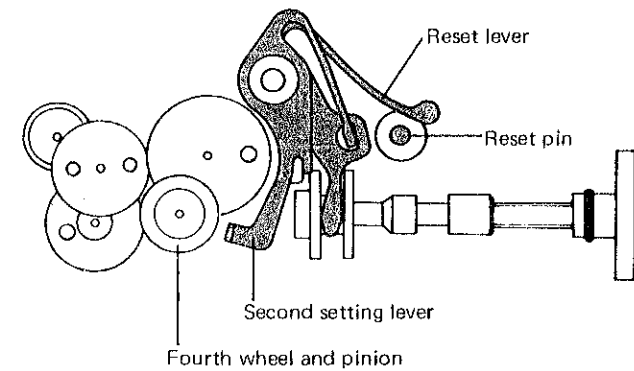

• List of screws used

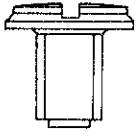
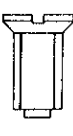
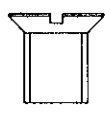
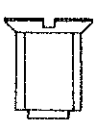
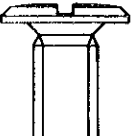
				
Third wheel bridge screw Circuit block screw A Coil block screw	Date driving wheel screw	Setting lever axle spring screw Screw for dial holding ring	Date dial guard screw	Circuit block screw B





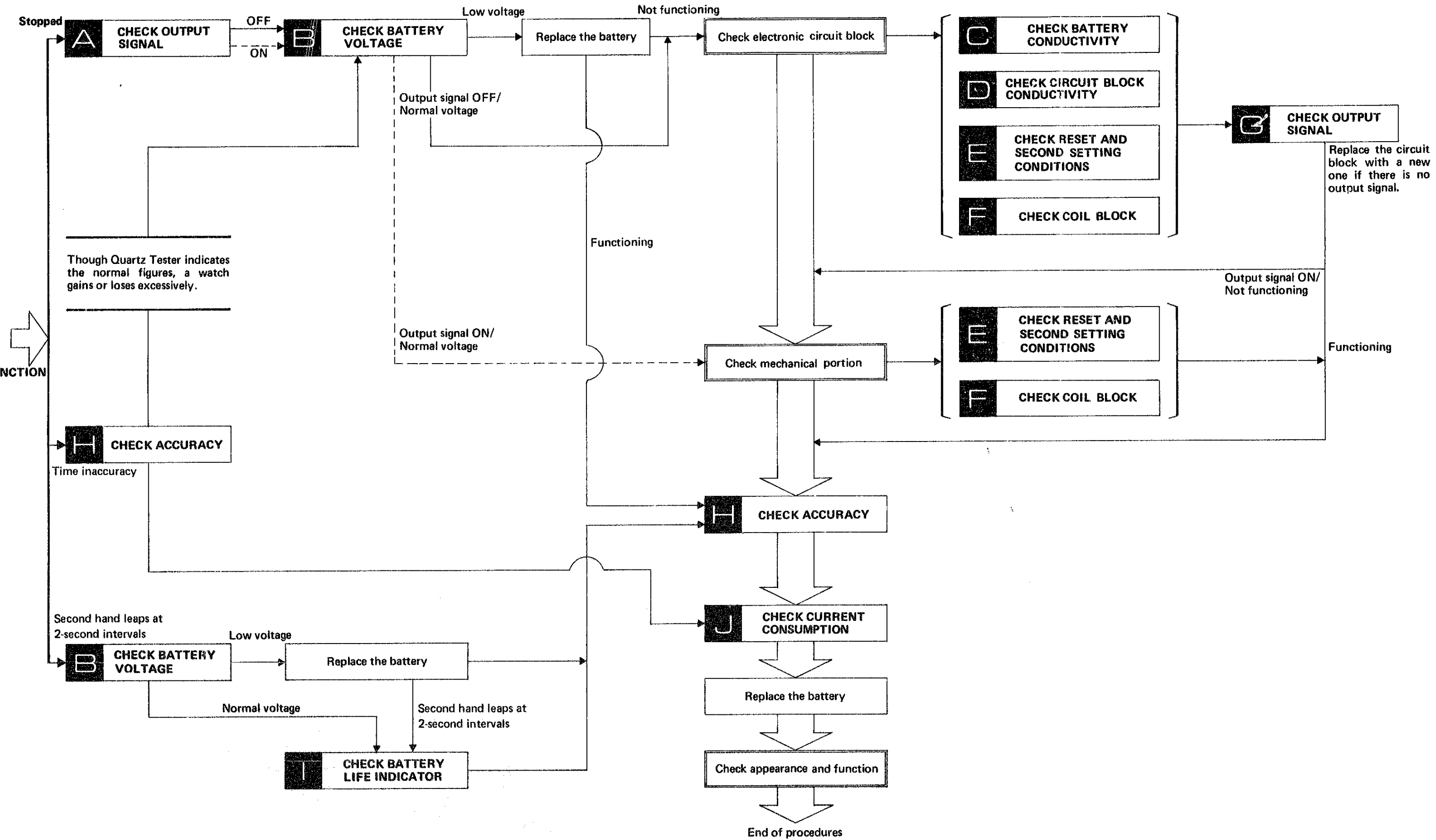

III. CHECKING AND ADJUSTMENT

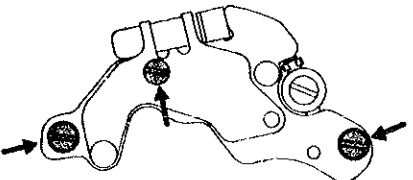
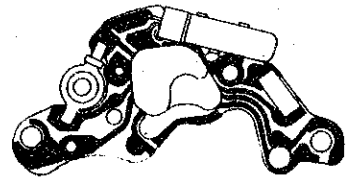
(1) Guide table for checking and adjustment

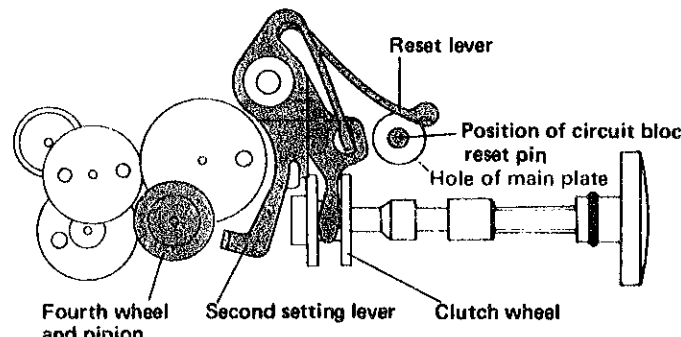

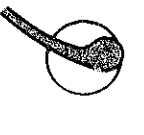
(2) Procedures for checking and adjustment

	Procedures	Results	Adjustment and Repair
CHECK OUTPUT SIGNAL	<p>A</p> <p>Check output signal</p>	<p>One-second blinking</p> <p>No one-second blinking</p>	<p>Proceed to B</p> <p>Proceed to B</p>
CHECK BATTERY VOLTAGE	<p>B</p> <p>Check battery voltage</p>	<p>More than 1.55V</p> <p>Less than 1.55V</p>	<p>In procedure A if one-second blinking is found, proceed to Check mechanical portion.</p> <p>In procedure A if one-second blinking is not found, proceed to Check electronic circuit block.</p> <p>Proceed to Replace the battery.</p> <p>If a watch operates after battery replacement, proceed to C.</p> <p>If a watch does not operate after battery replacement, proceed to Check electronic circuit block.</p>
CHECK BATTERY CONDUCTIVITY	<p>C</p> <p>Check battery conductivity</p> <p>1. Make sure that the coil block screw is tightened firmly.</p> <p>2. Check for any contamination on the connecting portion of battery, the battery connection, the plus terminal of battery connection and holding spring for battery.</p> 	<p>No loosened screw</p> <p>Loosened screw</p> <p>Uncontaminated</p> <p>Contaminated</p>	<p>Proceed to C 2.</p> <p>Retighten the screws.</p> <p>Proceed to D.</p> <p>Wipe off carefully.</p>
CHECK CIRCUIT BLOCK CONDUCTIVITY	<p>D</p> <p>Check circuit block conductivity</p> <p>1. Check to see if the circuit block screws (3 pcs.) are tightened firmly.</p>  <p>2. Check the circuit block for any break in the welded portion, short circuit, pattern break and contamination.</p> 	<p>No loosened screw</p> <p>Loosened screw</p> <p>No break in the welded portion, short circuit, pattern break, or contamination</p> <p>Break in the welded portion, short circuit, pattern break</p> <p>Contaminated</p>	<p>Proceed to D 2.</p> <p>Retighten the screw.</p> <p>Proceed to E.</p> <p>Replace the circuit block.</p> <p>Wipe off carefully.</p>

	Procedures	Results	Adjustment and Repair
CHECK RESET AND SECOND SETTING CONDITIONS	<p>F</p> <p>Check reset and second setting conditions</p> <p>1. Check to see if the second hand stops immediately after the crown is pulled out to the second click position and if it starts promptly one second after the crown is pushed in to the normal position.</p> <p>2. Check for the clearance between the reset lever and the reset pin (with the circuit block removed).</p>  <p>(1) Crown position: Normal, first click</p>  <p>(2) Crown position: Second click</p>  <p>3. Check for the clearance between the second setting lever and the fourth wheel and pinion (with the circuit block removed).</p>  <p>(1) Crown position: Normal, first click</p>  <p>(2) Crown position: Second click</p>  	<p>Stops completely and starts after one second</p> <p>Does not stop or moves irregularly</p> <p>Proceed to F 1.</p> <p>Proceed to F 2.</p> <p>Proceed to F 2. (2)</p> <p>Replace the reset lever.</p> <p>Proceed to F 3.</p> <p>Replace the reset lever.</p> <p>Proceed to F 3. (2)</p> <p>Replace the second setting lever.</p> <p>Proceed to F.</p> <p>Replace the second setting lever.</p>	<p>Adjustment and Repair</p>

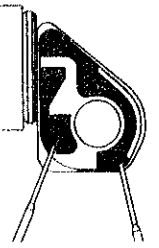
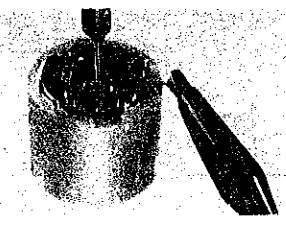
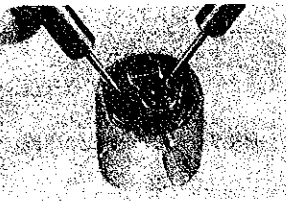
	Procedures	Results	Adjustment and Repair
CHECK COIL BLOCK	Check coil block 	2.0 K Ω ~ 4.0 K Ω Less than 2.0 K Ω Short circuit: More than 4.0 K Ω Broken coil wire	Check Electronic Circuit Block is being checked. Proceed to G . Check Mechanical Portion is being checked Proceed to H . Replace the coil block.
CHECK FOR OUTPUT SIGNAL	Check for output signal	One-second blinking No one-second blinking	Functioning Proceed to H Not functioning Proceed to Check mechanical portion Replace the circuit block.
CHECK ACCURACY	Check accuracy	Normal Defective	Replace the battery . Adjust time accuracy
CHECK BATTERY LIFE INDICATOR	Check battery life indicator Set up the Micro Test Clip red (+) Crown or winding stem Probe black (-) Battery connection 1. Set the voltage at 1.25V Check if the second hand moves at 2-second intervals.  2. Set the voltage at 1.55V. Check if the second hand moves at 1-second intervals.	The second hand moves at 2-second intervals. The second hand moves at 1-second intervals. The second hand moves at 1-second intervals. The second hand moves at 2-second intervals.	Proceed to I 2. intervals. Replace the circuit block. Proceed to J . Replace the circuit block
CHECK CURRENT CONSUMPTION	Check current consumption Place the battery on the third wheel bridge with its (-) surface faced up. Probe red (+) . . . Battery connection Probe black (-)...Battery surface (-) 	Less than 2.0 μ A More than 2.0 μ A	Normal Proceed to Check electronic circuit block . <i>Note:</i> If the pointer of the Volt-ohm-meter scales out and the current consumption cannot be measured, reset its range, e.g. at DC 30mA. Next, when the pointer is stabilized with the probes of the Volt-ohm-meter shown in the left illustration, return the range to DC 12 μ A (or DC 0.03mA) and read the value indicated. • The value of current consumption of the Cal. 26 series is the same as that of Cal. 2633.

All procedures of Disassembling, Reassembling, Checking and Adjustment are completed.