

SEIKO

QUARTZ

Cal. 4336A

PARTS LIST

Cal. 4336A

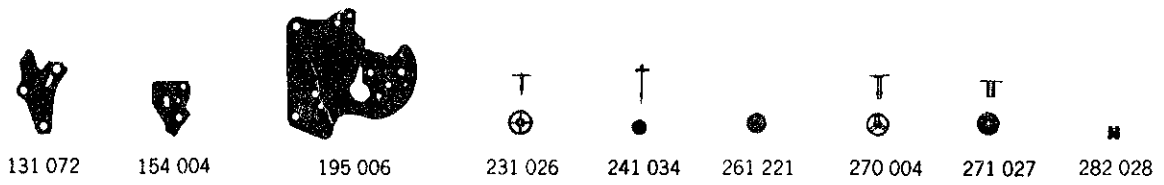
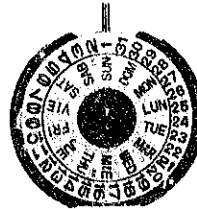
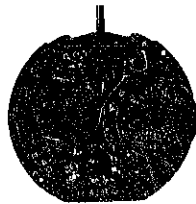

131 072 154 004 195 006 231 026 241 034 261 221 270 004 271 027 282 028

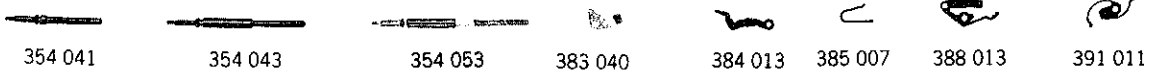

354 041 354 043 354 053 383 040 384 013 385 007 388 013 391 011

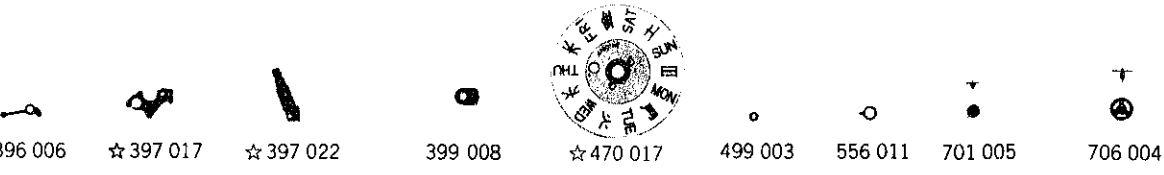

396 006 ☆ 397 017 ☆ 397 022 399 008 ☆ 470 017 499 003 556 011 701 005 706 004



☆ 801 057 802 015 803 003 808 018 810 008 817 011 868 009 873 013 884 085

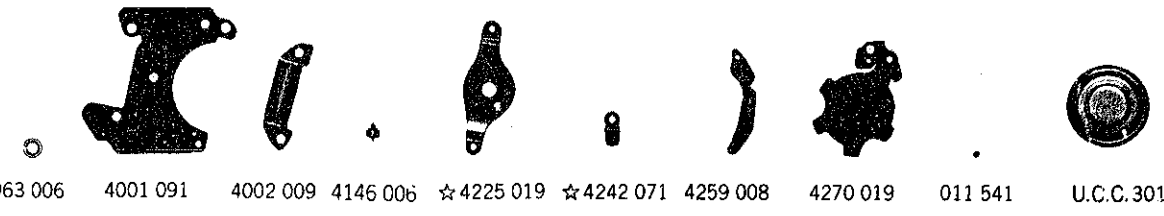

963 006 4001 091 4002 009 4146 006 ☆ 4225 019 ☆ 4242 071 4259 008 4270 019 011 541 U.C.C.301

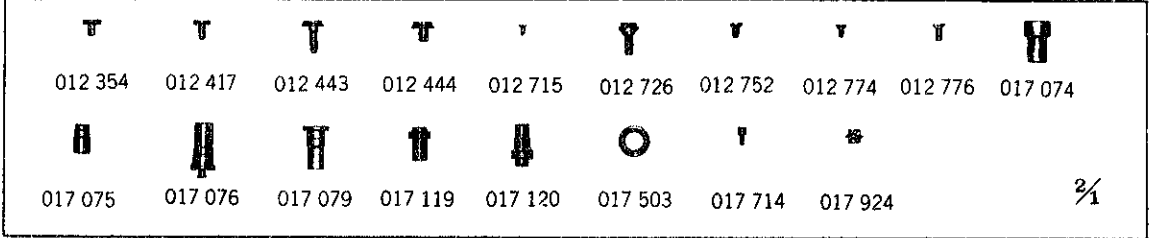

012 354 012 417 012 443 012 444 012 715 012 726 012 752 012 774 012 776 017 074
 017 075 017 076 017 079 017 119 017 120 017 503 017 714 017 924 2/1

☆⇨ Please see remarks on the next reverse page.

Cal. 4336A

Characteristics

Casing diameter : ϕ 25.60 mm
 Maximum height : 4.24 mm
 Jewels : 2J
 Frequency of quartz crystal oscillator : 32,768 Hz (Hz=Hertz Cycles per second)
 Driving system : Step motor system (2 poles)
 Regulation system : Trimmer condenser
 Second-setting device
 Calendar (day & date)
 Instant setting device for day & date calendar
 Bilingual change-over system for day of the week
 Battery life indicator : Second hand moves in two-second interval.

PART NO.	PART NAME	PART NO.	PART NAME
131 072	Third wheel bridge	012 417	Third wheel bridge screw
154 004	Fifth wheel bridge	012 443	Circuit block screw (screw for holding spring for battery, screw for plus terminal of battery connection)
195 006	Calendar plate	012 444	Calendar plate screw
231 026	Third wheel & pinion	012 715	Back plate (anti-magnetic) screw
241 034	Fourth wheel & pinion	012 726	Casing clamp screw
261 221	Minute wheel	012 752	Fifth wheel bridge screw
270 004	Center minute wheel	012 774	Date driving wheel screw
271 027	Hour wheel	012 774	Date dial guard screw
282 028	Clutch wheel	012 776	Screw for dial holding ring
354 041	Winding stem (12.89 mm)	017 074	Stopper tube for circuit block
354 043	Winding stem (17.89 mm)	017 075	Tube for third wheel bridge screw A
354 053	Winding stem (20.89 mm)	017 076	Tube for circuit block screw A
383 040	Setting lever	017 079	Tube for circuit block screw B
384 013	Yoke (Clutch lever)	017 119	Tube for third wheel bridge screw B
385 007	Yoke spring (Clutch lever spring)	017 120	Tube for battery connection
388 013	Setting lever spring	017 503	Spacer for circuit block
391 011	Second setting lever	017 714	Lower bush for fifth wheel
396 006	Friction spring for fourth wheel & pinion	017 924	Eccentric dial pin
☆397 017 }	Lever for unlocking stem	U.C.C.301	Silver oxide battery
☆397 022 }			
399 008	Casing clamp		
☆470 017	Day star with dial disk		
499 003	Day finger ring		
556 011	Date finger		
701 005	Fifth wheel		
706 004	Sixth wheel & pinion		
☆801 057	Date dial		
802 015	Date driving wheel		
803 003	Setting wheel lever complete		
808 018	Date dial guard		
810 008	Date jumper		
817 011	Intermediate date wheel		
868 009	Day finger		
873 013	Day jumper		
884 085	Holding ring for dial		
963 006	Snap for day star with dial disk		
4001 091	Circuit block		
4002 009	Coil block		
4146 006	Step rotor		
☆4225 019	Holding spring for battery		
☆4242 071	Plus terminal of battery connection		
4259 008	Back plate (anti-magnetic)		
4270 019	Battery connection		
011 541	Upper hole jewel for step rotor		
011 541	Lower hole jewel for step rotor		
012 354	Setting lever spring screw		

☆⇒ Please see remarks on the reverse page.

Cal. 4336A

Remarks :

Lever for unlocking stem

☆397 017.....Used when the winding stem is removed by pushing the lever for unlocking stem from the case back side.

☆397 022.....Used when the winding stem is removed by pushing the lever for unlocking stem from the dial side.

Day star with dial disk

☆470 017(English ↔ Spanish, black figures on white background).....Used when both the crown and the calendar frame are located at 3 o'clock position.

If any other type of day star with dial disk is required, specify the number printed on the disk.

Date dial

☆801 057(Black figures on white background).....Used when both the crown and the calendar frame are located at 3 o'clock position.

If any other type of date dial is required, specify ① Cal. No. ② jewels ③ the crown position ④ the calendar frame position and ⑤ Dial No.

Holding spring for battery

☆4225 019.....Used only for case without battery hatch.

Plus terminal of battery connection

☆4242 071.....Used only for case with battery hatch.

TECHNICAL GUIDE

SEIKO

QUARTZ

CAL.4336A

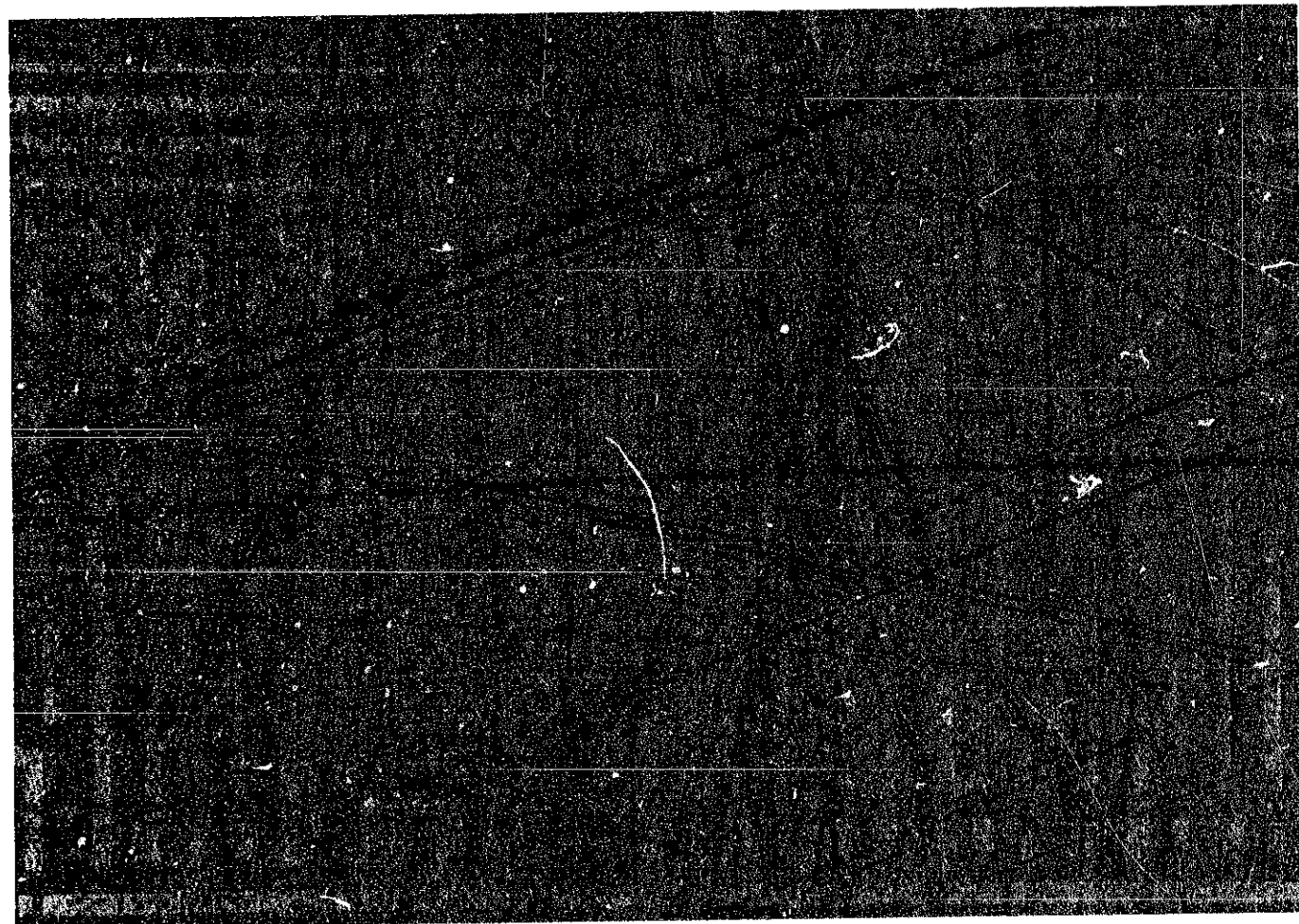

CONTENTS

I. SPECIFICATIONS AND FEATURES	1
1. Specifications	1
2. Features	1
II. AFTER-SALE SERVICING INSTRUMENTS AND MATERIALS	2
III. DISASSEMBLING AND REASSEMBLING OF THE CASE	3
IV. DISASSEMBLING, REASSEMBLING, LUBRICATING AND CLEANING	5
(1) Calendar mechanism	5
(2) Electronic circuit and gear train mechanism	7
(3) Setting mechanism	9
(4) Cleaning	11
V. CHECKING AND ADJUSTMENT	12
(1) Guide table for checking and adjustment	12
(2) Procedures for checking and adjustment	13
A: Check output signal	13
B: Check battery voltage	13
C: Check battery conductivity	13
D: Check circuit block conductivity	13
E: Check reset condition	15
F: Check coil block	15
G: Check output signal	15
H: Check accuracy	15
I: Check battery life indicator	17
J: Check current consumption	17

SEIKO Quartz Cal. 4336A

SEIKO Quartz Cal. 4336A is a highly efficient quartz crystal oscillator watch which has the same high accuracy and reliability as other SEIKO Quartz Crystal watches. As Cal. 4336A is designed to operate with the lowest possible current consumption, its battery life has been lengthened to approximately five years.

Calibre 4336A

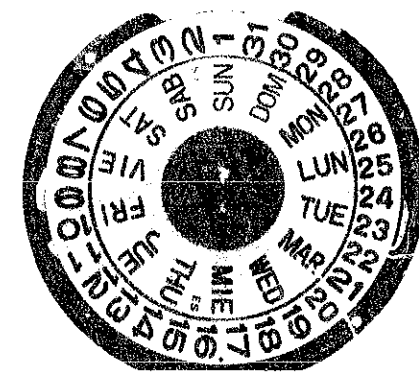
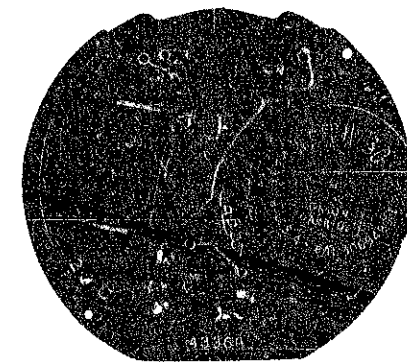

Movement

I. SPECIFICATIONS AND FEATURES

1. Specifications

Item	Cal. No. 4336A
Additional mechanism	Calendar (day & date) Bilingual change-over system for the day of the week Instant day and date setting Second setting device (stops at every second) Battery life indicator Electronic circuit reset switch
Crystal oscillator	32,768 Hz (Hz = Hertz . . . Cycles per second)
Loss/gain	Loss/gain at normal temperature Monthly rate: less than 15 seconds Annual rate: less than 3 minutes
Casing diameter	φ25.6 mm (23.7 mm between 3 o'clock and 9 o'clock sides)
Height	4.2 mm
Operational temperature range	-10°C ~ +60°C (14°F ~ 140°F)
Driving system	Step motor system (2 poles)
Regulation system	Trimmer condenser
Battery power	Silver oxide battery (U.C.C. 301) Battery life is approximately 5 years. Voltage 1.5V
Jewels	2 jewels

2. Features

- (1) Cal. 4336A is a highly accurate and reliable quartz crystal oscillator watch which has succeeded to all the characteristics of the existing SEIKO Quartz Crystal watches.
- (2) The battery life indicator signals the second hand to move in two second intervals instead of the normal one second interval when the battery life is coming to its end. This indicates the battery must be replaced. The watch will, however, remain accurate while the second hand is moving in two second intervals.
- (3) A single battery allows the watch to operate as long as approximately 5 years.

II. AFTER-SALE SERVICING INSTRUMENTS AND MATERIALS

For after-sale servicing of SEIKO Quartz Crystal watch Cal. 4336A, the following after-sale servicing instruments and materials are necessary.

(1) Quartz Tester

Used to check time accuracy (daily rates).

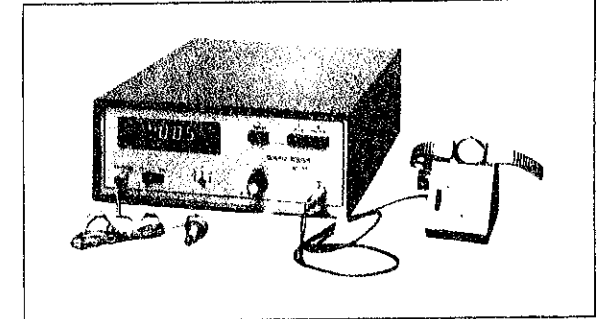

(2) Micro Test

Used to check current consumption and to flow voltage power constantly.

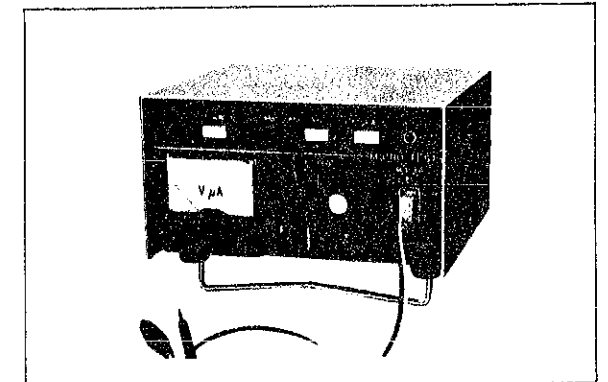

(3) Volt-ohm-meter (S-831)

Used to check battery voltage and its conductivity.

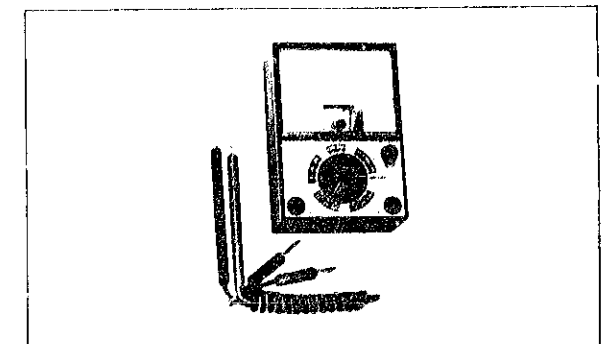

(4) Movement holder (S-651)

Used for disassembling, reassembling, checking and adjusting of the movement.

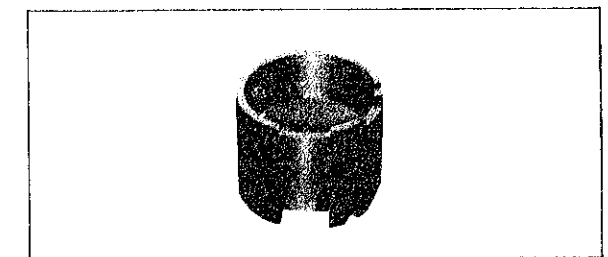

(5) Anti-magnetic tweezers

Used for handling the step rotor.

III. DISASSEMBLING AND REASSEMBLING OF THE CASE

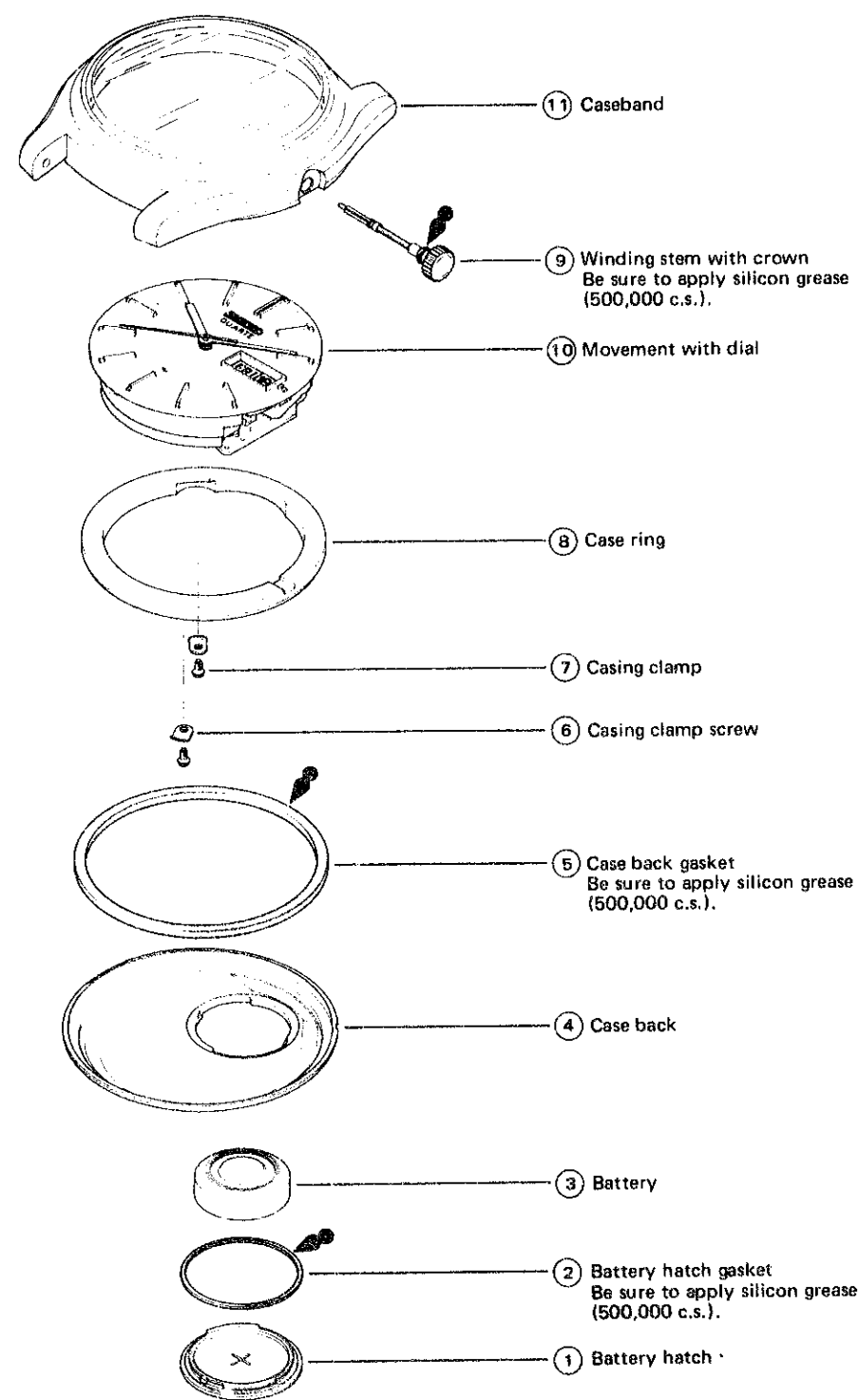

Remarks for disassembling and reassembling

How to disassemble the winding stem with crown (9).

- From the circuit block side

The pin of the lever for unlocking stem is seen at the hole (arrow marked portion) of the circuit block as shown in the illustration on the right. Push down the pin and disassemble the winding stem with crown.

- From the dial side

When the crown is at the normal position, a part of the lever for unlocking stem is seen at the side of the stem. Push down the part and disassemble the winding stem with crown.

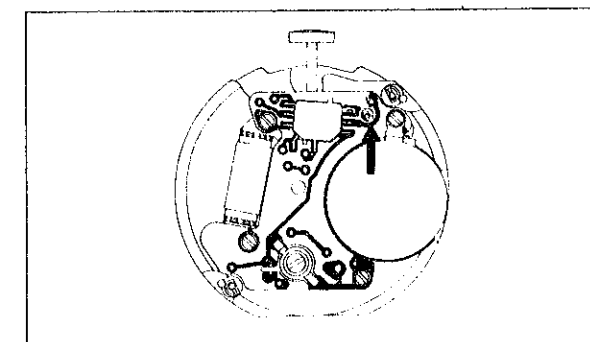

How to disassemble the caseband (11) (glass).

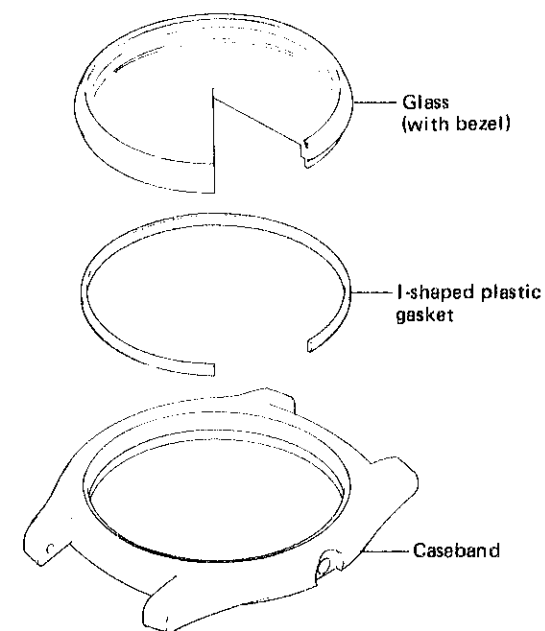

- How to disassemble the glass (with bezel)

Set the caseband onto the supporting disk as shown in the illustration, and push the bezel from inside by the inserting disk for disassembling.

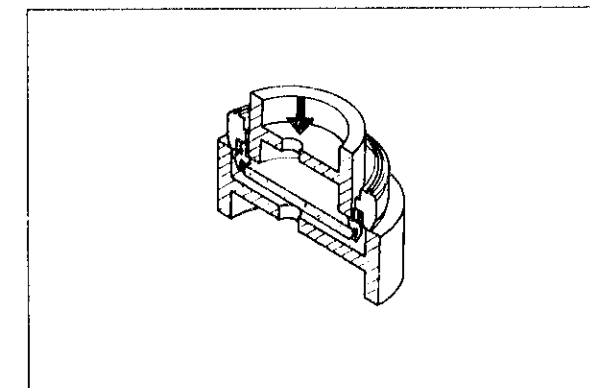

- How to reassemble the glass (with bezel)

Set the caseband onto the supporting disk as shown in the illustration, and push the bezel from outside by the inserting disk for reassembling. Be sure to replace the I-shaped plastic gasket with a new one.

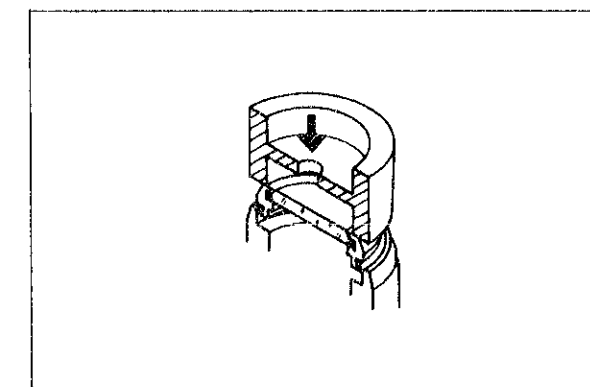

IV. DISASSEMBLING, REASSEMBLING, LUBRICATING AND CLEANING

Disassembling and Reassembling

Disassembling procedures Figs.: ① → ⑥⑦

Reassembling procedures Figs.: ⑥⑦ → ①

Lubricating

Types of oil

● Moebius A

○ SEIKO watch Oil S-6

Oil quantity

○ Liberal

○ Normal

○ Extremely small

(1) Calendar mechanism

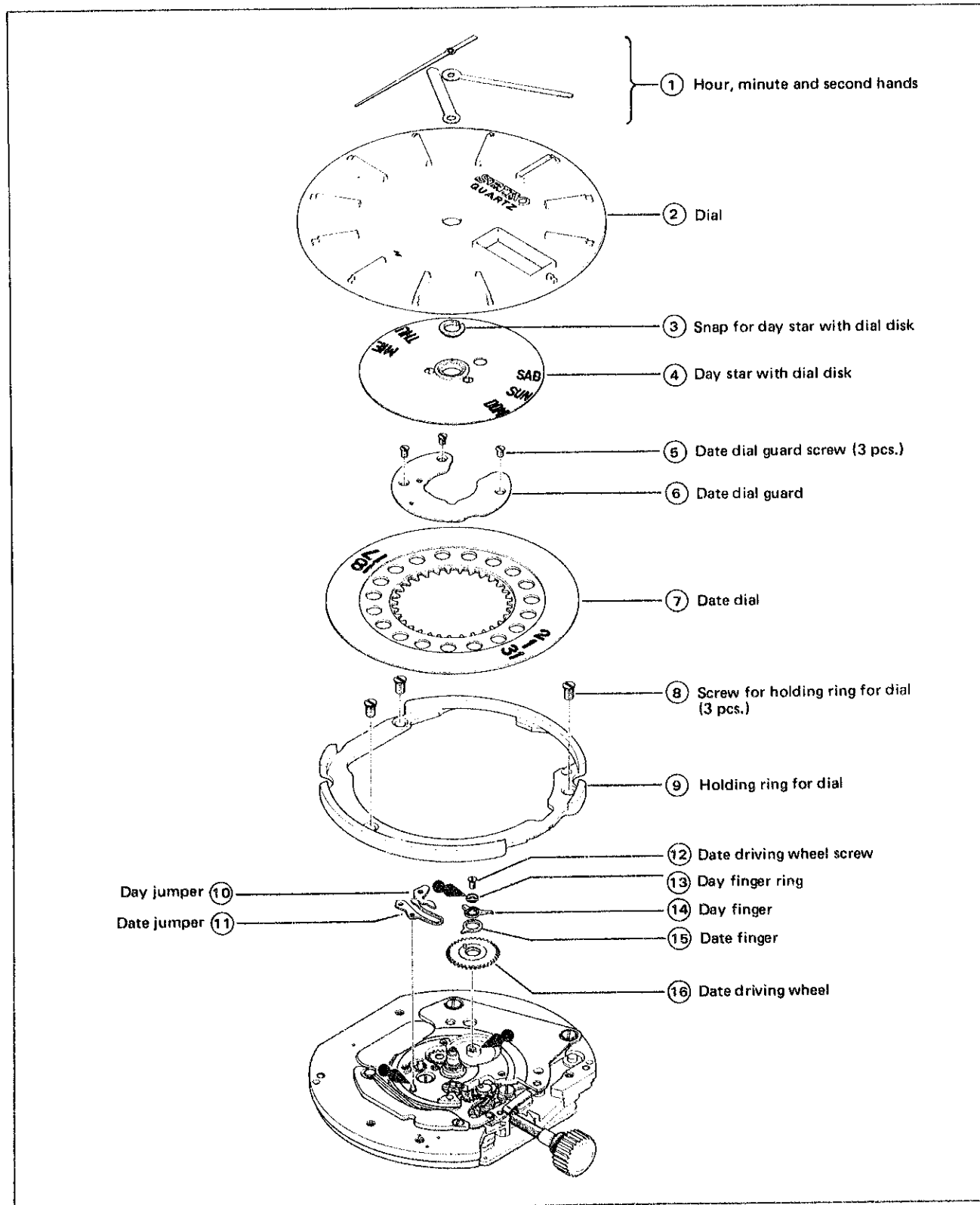

Remarks for disassembling and reassembling

How to disassemble and reassemble the hands ①.

When disassembling or reassembling, always pull the crown out to the second click position. The second hand must be placed just in line with a second mark. (Either odd or even second mark will do.)

How to disassemble and reassemble the dial ②.

After turning the eccentric dial pin between $90^\circ \sim 150^\circ$, disassembling and reassembling of the dial is possible.

How to turn the eccentric dial pin.

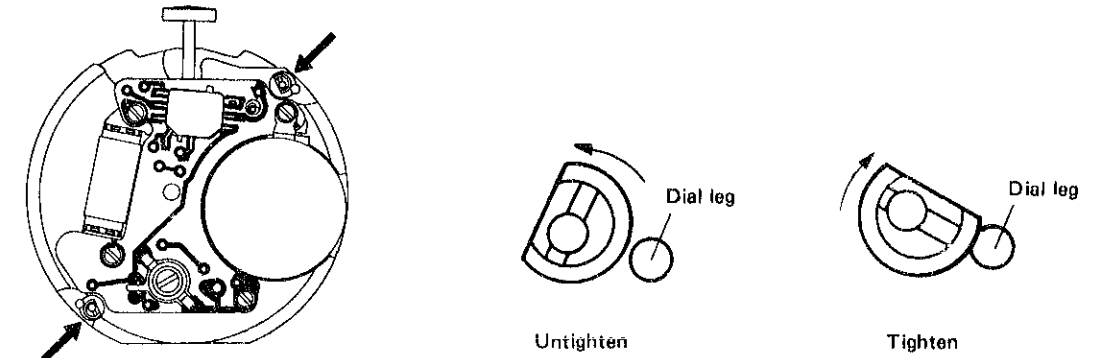

How to reassemble the day finger and the date finger ⑭ ⑮.



(2) Electronic circuit and gear train mechanism

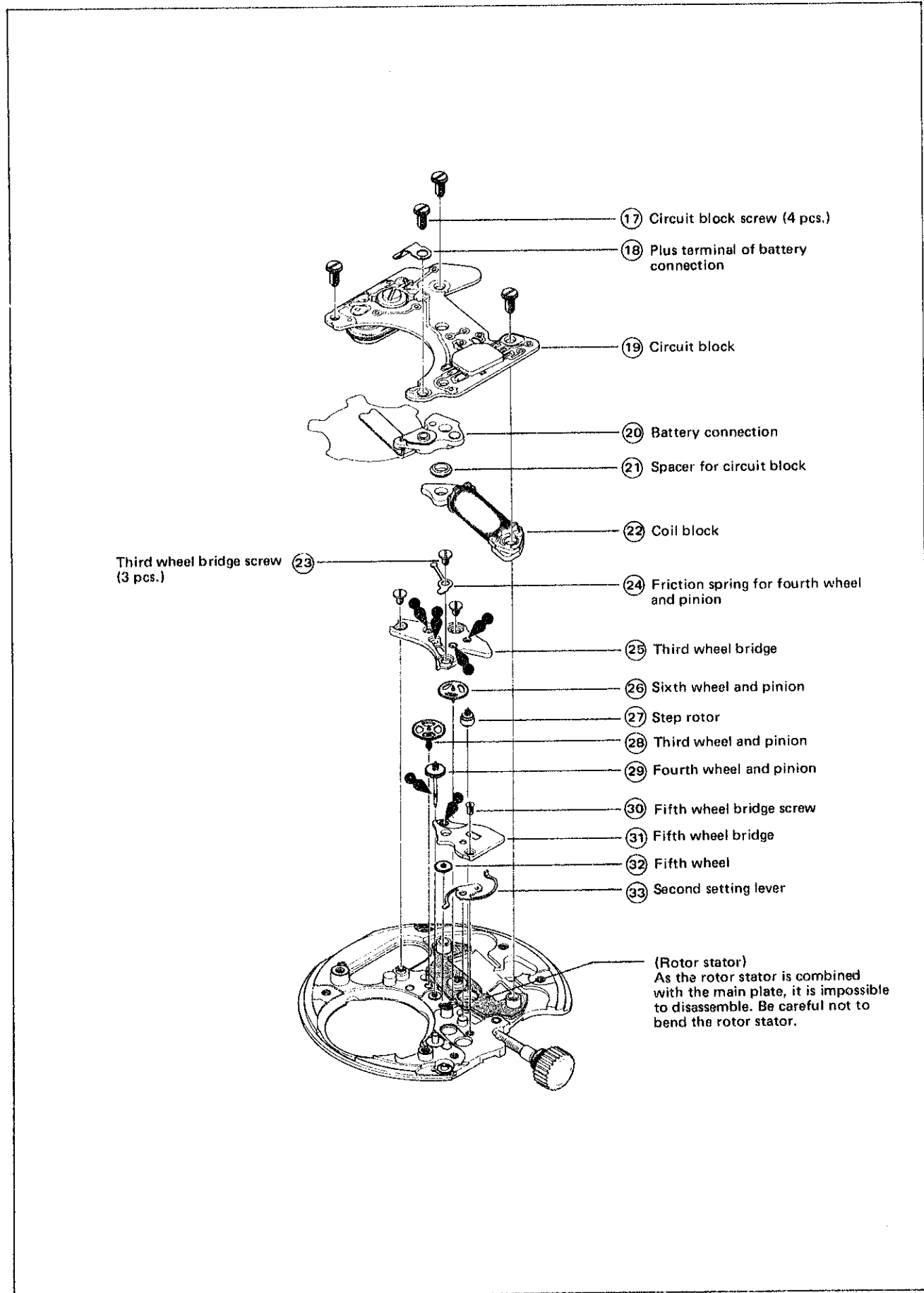

Remarks for disassembling and reassembling

- How to use the holding spring for battery and the plus terminal of battery connection (18)
If the watch is provided with the holding spring for battery, the plus terminal of battery connection is not used.

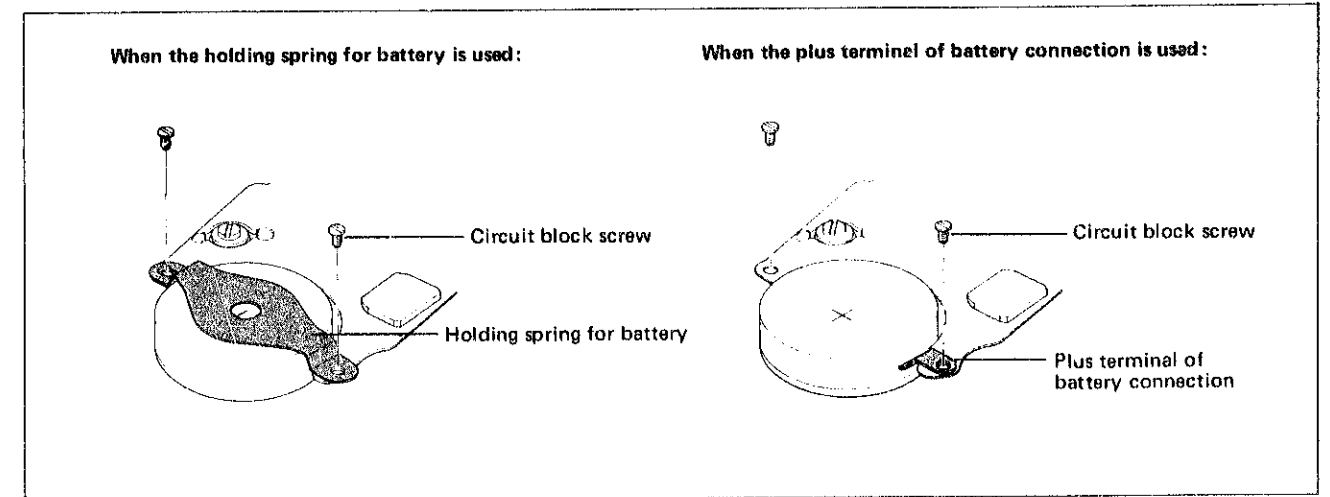

- Check to see that there is clearance between the second setting lever and the sixth wheel and pinion (26)

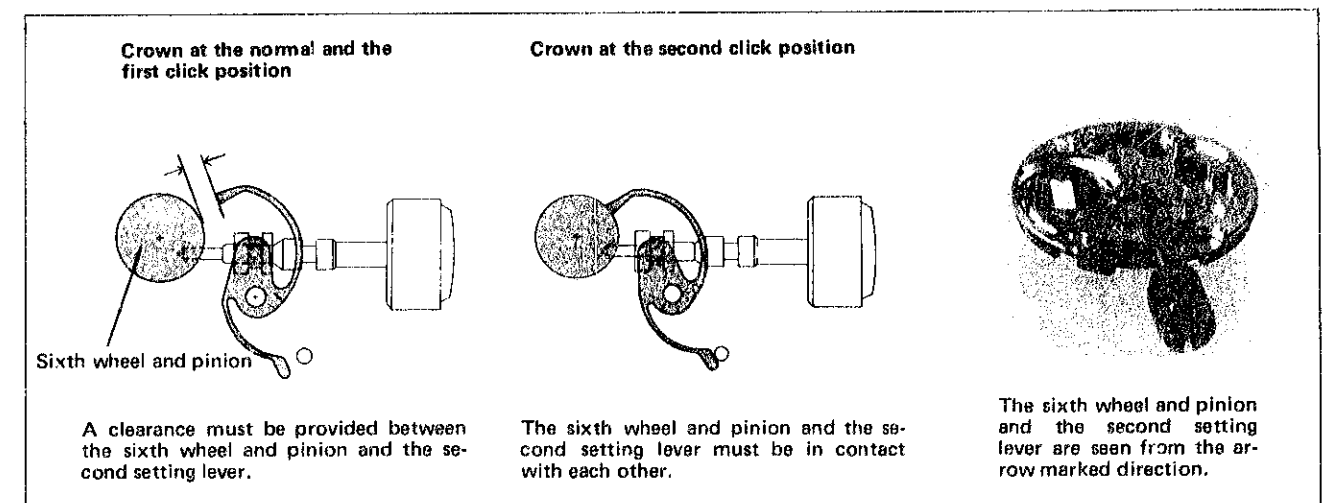

- Check to see that there is clearance between the second setting lever and the reset pin (19)

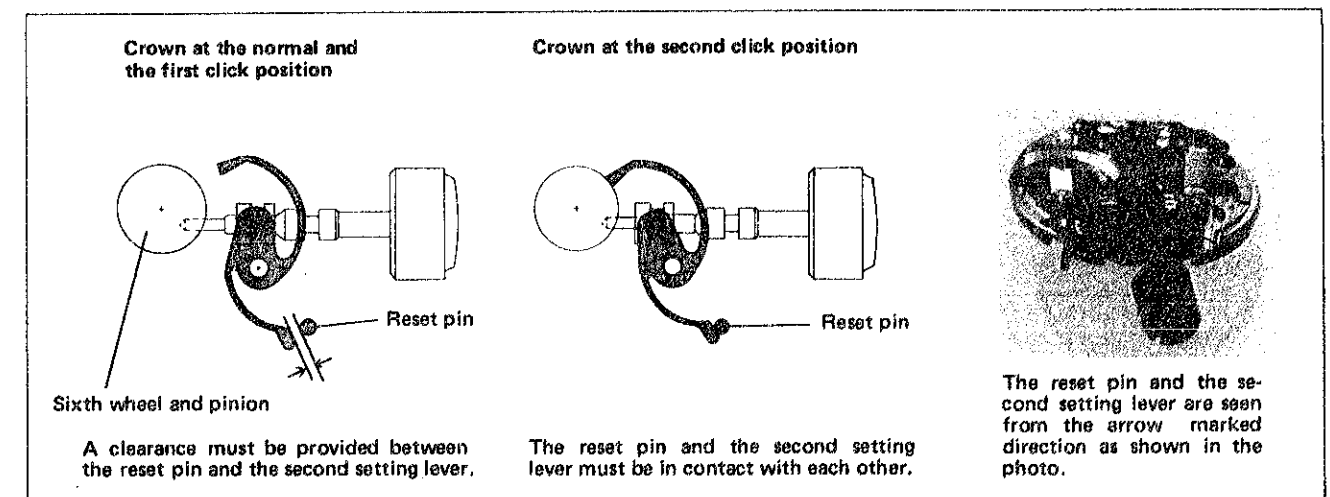

(3) Setting mechanism

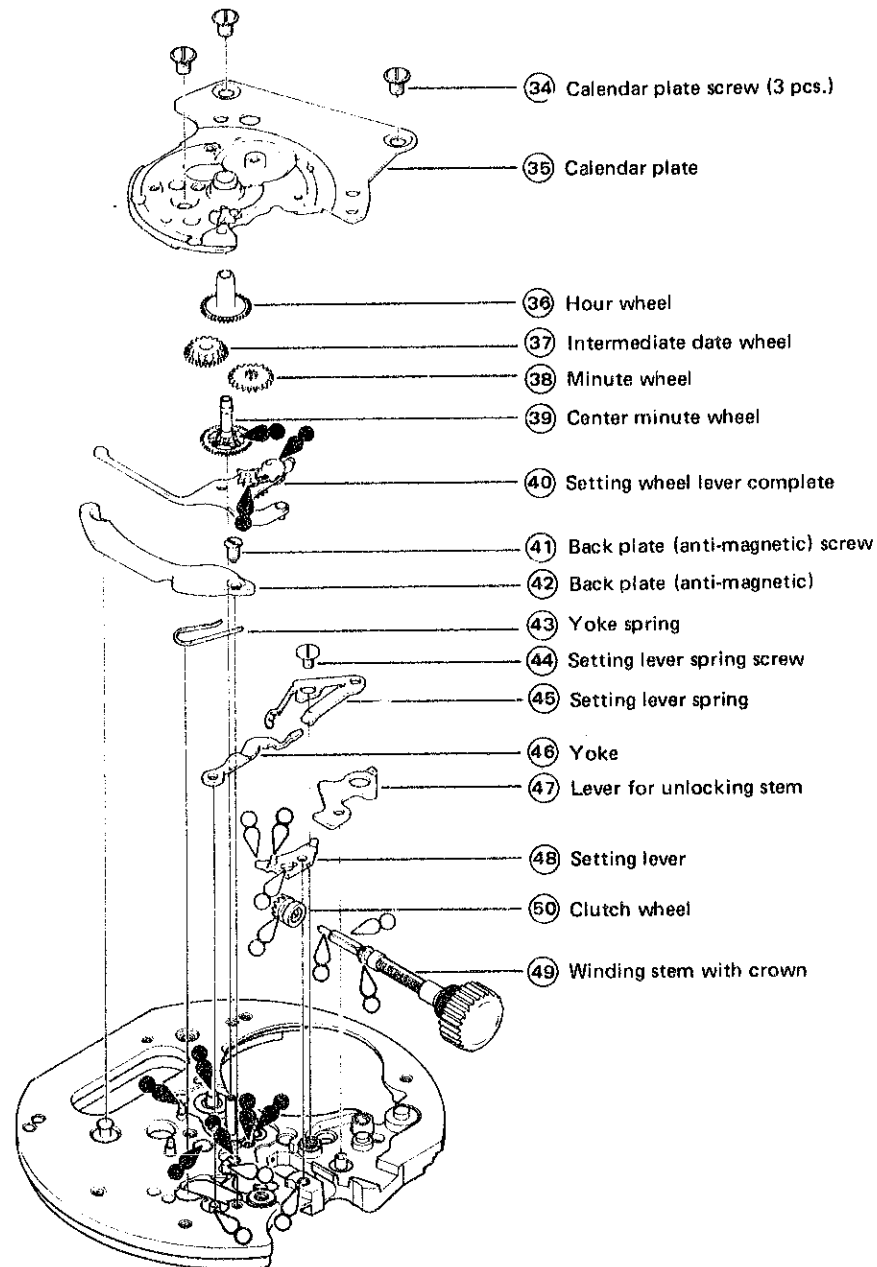

Remarks for disassembling and reassembling

● **Lubrication of the center minute wheel (39)**
Do not disassemble the cannon pinion from the center minute wheel.

● **Lubrication of the setting wheel lever complete (40)**
Pull out the crown to the first click position. Turn the crown and check to see if the day-date correction wheel rocker moves smoothly. If it does not move smoothly, clean it and lubricate again.

● **Lever for unlocking stem (47)**
There are two types of lever for unlocking stem as shown in the illustration on the right. Be careful not to mistake one for another as they are used in different types of cases.

This lever for unlocking stem is used in the case which is designed so that the winding stem is disassembled from the case back side. (Push the pin of the lever for unlocking stem to disassemble the winding stem.)

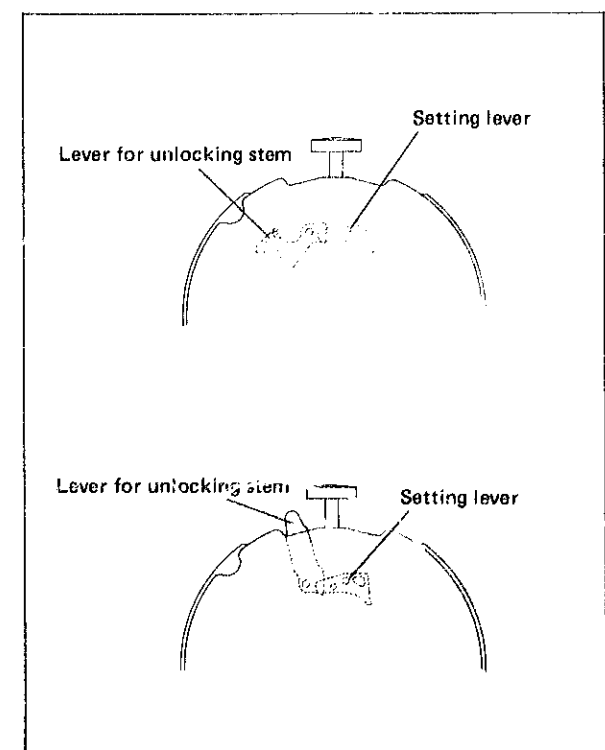
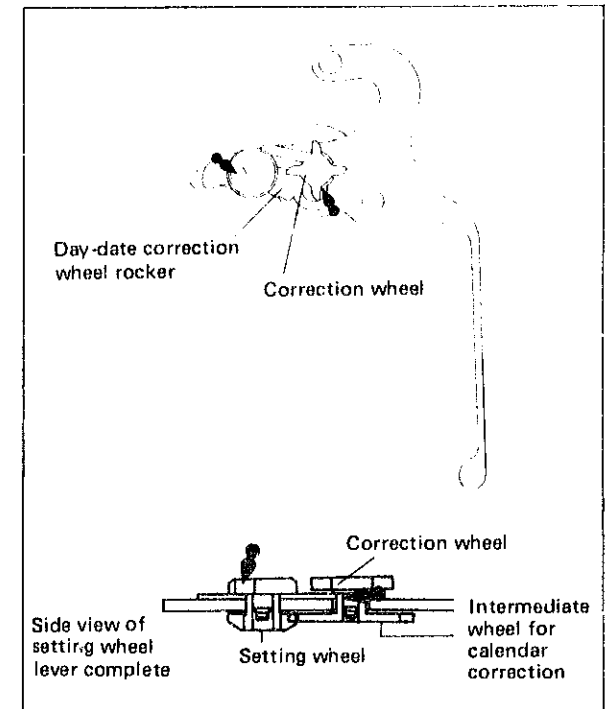
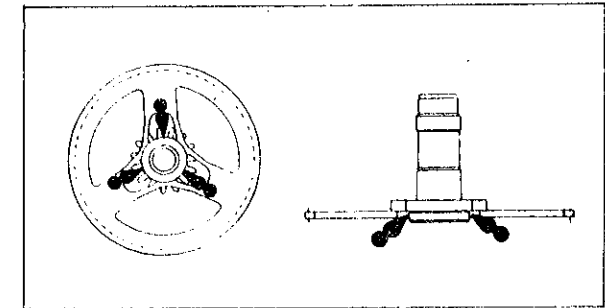

This lever for unlocking stem is used in the case which is designed so that the winding stem is disassembled from the dial side. (Push the tail of the lever for unlocking stem to disassemble the winding stem.)



(4) Cleaning

Since several parts (electronic parts, etc.) of Cal. 4336A differ from those of the conventional mechanical watches, use the following method when cleaning.

1. HOW TO CLEAN

Name of parts	Cleaning	Drying	Solution	Remarks
Main plate  Step rotor 	Rinse or wash with a soft brush.	Cool air	Benzine	<ul style="list-style-type: none"> Do not disassemble the parts combined with the main plate. Use a clean solution as the step rotor has a magnet. Use adhesive tape or Rodico to remove dust and fillings which cannot be cleaned with the solution.
Plastic parts	Rinse or wash with a soft brush.	Cool air	Benzine or alcohol	
Other parts (except circuit block and coil block)	Clean with cleaner, rinse or wash with a soft brush.	Cool or hot air	Benzine or trichloroethylene	

2. PARTS THAT MUST NOT BE CLEANED

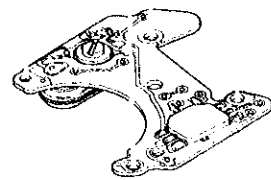

Circuit block

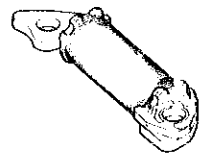

Coil block

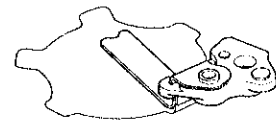

Battery connection

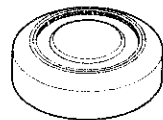

Battery



- Only the conductive portions should be wiped with a cloth moistened with benzine or alcohol and dried with cool air.
- Wipe stain on the battery with a dry cloth.

V. CHECKING AND ADJUSTMENT

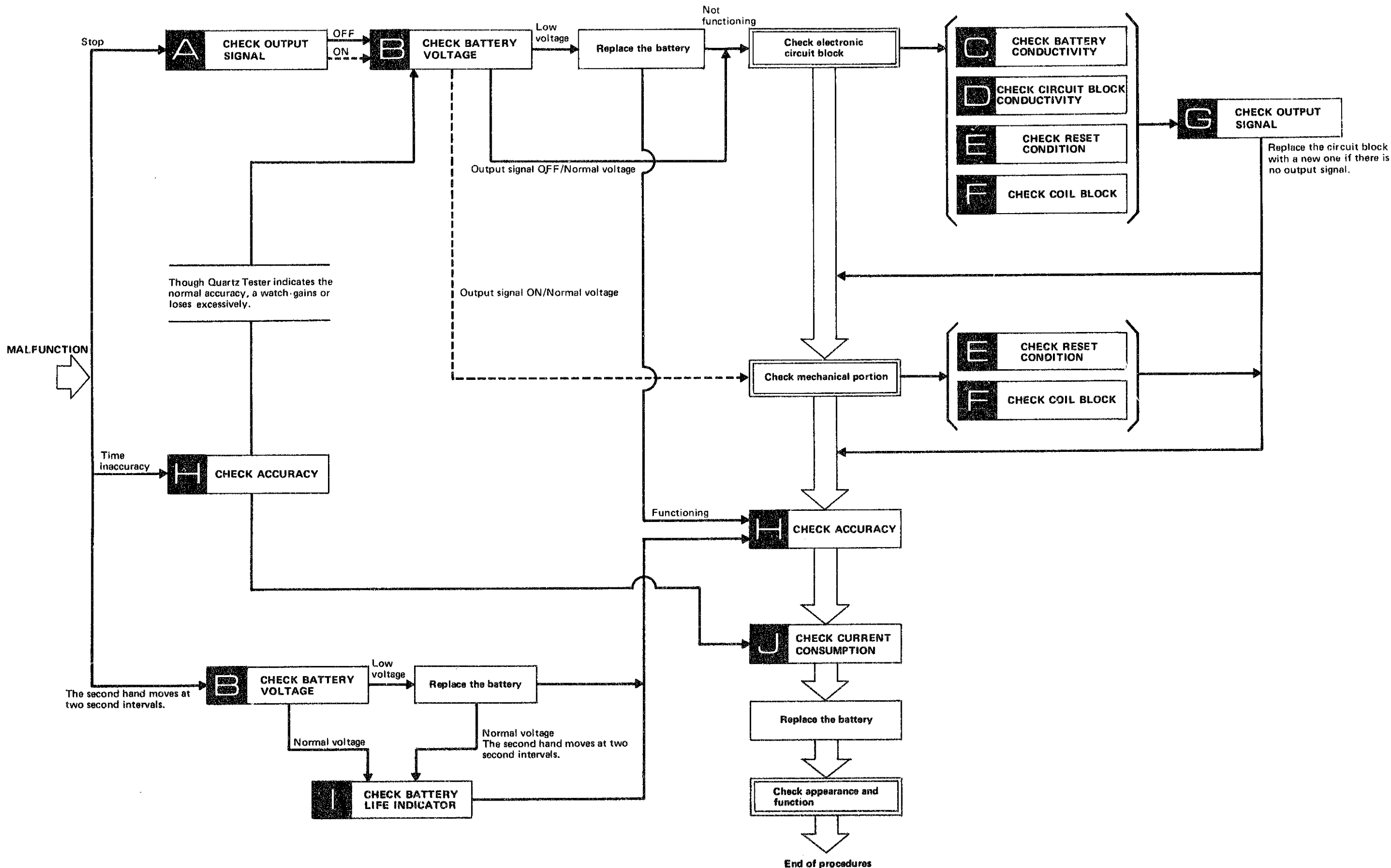

(1) Guide table for checking and adjustment

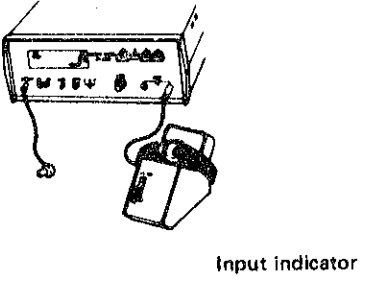
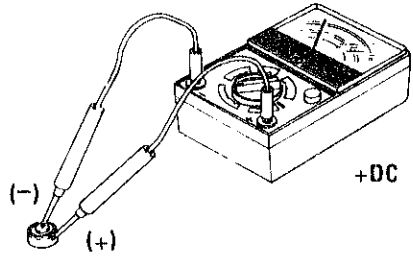
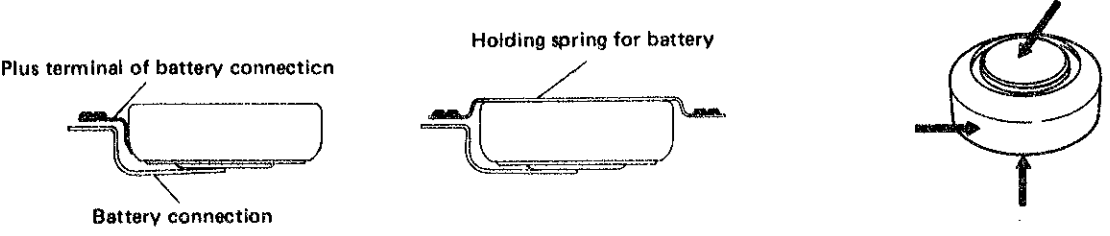

(2) Procedures for checking and adjustment

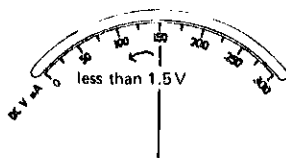
	Procedure
CHECK OUTPUT SIGNAL	<p>Check output signal.</p> <p>(1) Set up the Quartz Tester.</p> <p>(2) Checking Check for blinking input indication lamp.</p>  <p style="text-align: center;">Input Indicator</p>
CHECK BATTERY VOLTAGE	<p>Use the following procedures to check battery voltage.</p> <p>(1) Set up the volt-ohm-meter. Range to be used: DC 3 V</p> <p>(2) Measuring</p> <ul style="list-style-type: none"> • Probe Red (+) Battery surface (+) • Probe Black (-) Battery surface (-) <p>Note: When handling the battery, be sure to use non-metallic tweezers or fingercots.</p> 
CHECK BATTERY CONDUCTIVITY	<p>Check to see if the battery current flow to the circuit is normal.</p> <p>(1) Make sure that the screws (circuit block screws) for both the holding spring for battery and the plus terminal of battery connection are tightened firmly.</p> <p>(2) Check for any contamination on the connecting portions of the battery, the holding spring for battery, the battery connection and the plus terminal of battery connection.</p> 
CHECK CIRCUIT BLOCK CONDUCTIVITY	<p>Check for short circuit and defective conductivity of the conductive portion of the circuit block.</p> <p>(1) Check to see if the circuit block screws (4 pcs.) are tightened firmly.</p> <p>(2) Check the circuit block for any break in the welded portion, short circuit, pattern break or contamination.</p> 

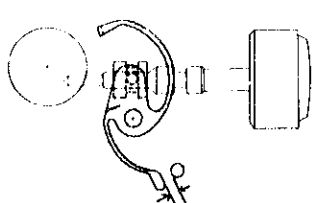
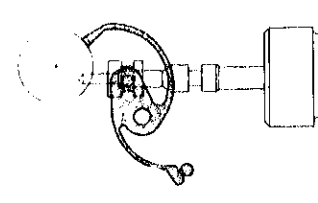
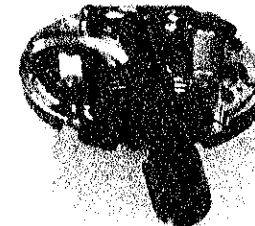
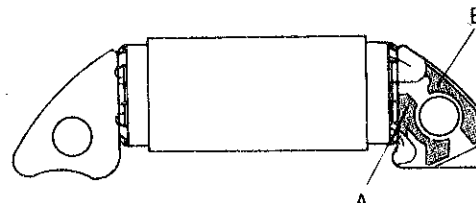
Result	Adjustment and Repair
<p>One-second blinking</p> <p>No one-second blinking</p>	<p>Proceed to B.</p>
<p>More than 1.5 V</p> <p>Less than 1.5 V</p> 	<p>In procedure A if one-second blinking is found, proceed to Check mechanical portion.</p> <p>In procedure A if one-second blinking is not found, proceed to Check electronic circuit block.</p> <p>Proceed to Replace the battery.</p> <ul style="list-style-type: none"> • If the watch operates after the battery replacement, proceed to H. • If the watch does not operate, proceed to Check electronic circuit block.
<p>No loosened screw</p> <p>Loosened screw</p> <p>Uncontaminated</p> <p>Contaminated</p>	<p>Proceed to C (2).</p> <p>Retighten the screw.</p> <p>Proceed to D.</p> <p>Wipe off carefully.</p>
<p>No loosened screw</p> <p>Loosened screw</p> <p>No break in the welded portion, short circuit, pattern break or contamination</p> <p>Break in the welded portion, short circuit, pattern break or contamination</p>	<p>Proceed to D (2).</p> <p>Retighten the screw.</p> <p>Proceed to E.</p> <ul style="list-style-type: none"> • Replace the circuit block if there is any break in the welded portion, short circuit or pattern break. • Wipe off carefully if contaminated.

	Procedure	Result	Adjustment and Repair
CHECK RESET CONDITION	<p>Check the reset condition after the circuit block is reassembled.</p> <p>(1) Check to see if the second hand stops immediately when the crown is pulled out to the second click position and if it starts immediately one second after the crown is pushed back in to the normal position. Check the above by checking the output signal with Quartz Tester or after reassembling the second hand to the movement.</p> <p>(2) Check for the clearance between the second setting lever and the reset pin.</p> <div style="display: flex; justify-content: space-around; align-items: flex-start;"> <div style="text-align: center;"> <p>Crown at the normal or first click position</p>  <p>There must be clearance between the reset pin and the second setting lever.</p> </div> <div style="text-align: center;"> <p>Crown at the second click position</p>  <p>There must not be clearance between the reset pin and the second setting lever.</p> </div> <div style="text-align: center;">  <p>Check from the arrow marked direction.</p> </div> </div>	<p>Stops immediately and starts moving after one second. →</p> <p>Does not stop immediately or moves irregularly. →</p> <p>Clearance when the crown is at the normal position and when it is pulled out to the first click, and no clearance when the crown is pulled out to the second click. →</p> <p>No clearance when the crown is at the normal position and when it is pulled out to the first click, or clearance when the crown is pulled out to the second click. →</p>	<p>Proceed to F.</p> <p>Proceed to E (2).</p> <p>Proceed to F.</p> <p>Replace the second setting lever with a new one.</p>
CHECK COIL BLOCK	<p>Check for broken coil wire and short circuit.</p> <p>(1) Set up the Volt-ohm-meter. Range to be used: OHMS R x 100</p> <p>(2) Measuring Apply the red and black probes of the Volt-ohm-meter to the two lead terminals A and B of the coil block.</p> <div style="text-align: center;">  </div>	<p>2.5 KΩ ~ 4.5 KΩ →</p> <p>Less than 2.5 KΩ (short circuit) →</p> <p>More than 4.5 KΩ (broken coil wire) →</p>	<ul style="list-style-type: none"> • Electronic circuit block is being checked. → Proceed to G • Mechanical portion is being checked. → Proceed to H <p>Replace the coil block with a new one.</p>
CHECK OUTPUT SIGNAL	<p>Check for output signal.</p> <p>(1) Set up the Quartz Tester.</p> <p>(2) Checking Follow the same procedures as in A.</p> <div style="text-align: center;">  </div>	<p>One-second blinking →</p> <p style="margin-left: 20px;">Functioning →</p> <p style="margin-left: 20px;">Not functioning →</p> <p>No one-second blinking →</p>	<p>Proceed to H.</p> <p>Proceed to Check mechanical portion.</p> <p>Replace the circuit block with a new one.</p>
CHECK ACCURACY	<p>Check gain and loss of time.</p> <p>(1) Set up the Quartz Tester.</p> <p>(2) Measuring Read the daily rate accuracy indicated on the display.</p> <div style="text-align: center;"> <p>*Time accuracy adjusting</p>  <p>Time accuracy is adjusted by turning the trimmer condenser.</p> </div>	<p>Normal →</p> <p>Defective →</p>	<p>Proceed to Replace the battery.</p> <p>Adjust time accuracy.</p>

Procedure

Check to see if the battery life indicator functions correctly.

First check

- (1) Set up the Micro Test.
Set the voltage at 1.1V.
- (2) Apply the probe of the Micro Test to the movement with the second hand, and check to see if the second hand moves at two second intervals.
Clip Red (+) Winding stem or crown
Probe Black (-) Battery connection

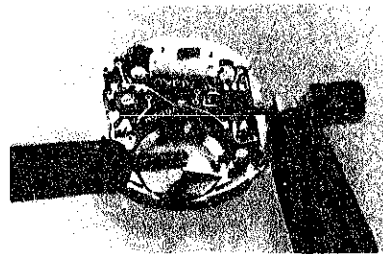

Second check

- (1) Set up the Micro Test.
Set the voltage at 1.5V.
- (2) Apply the probe of the Micro Test to the movement with the second hand, and check to see if the second hand moves at every second.

Result

The second hand moves at two second intervals. →

Normal

The second hand moves at every second intervals. →

Defective
Replace the circuit block with a new one.

The second hand moves at every second intervals. →

Normal

The second hand moves at two second intervals. →

Defective
Replace the circuit block with a new one.

Adjustment and Repair

In case where a frequent battery change is required, make a current consumption test by following the procedures below.

- (1) Set up the Volt-ohm-meter
 - Range to be used: DC 0.03 mA or 12 μ A
 - Set up the condenser kit of 200 ~ 500 μ F as shown in the photo.
- (2) Measuring
 - Watch with a battery hatch:
Probe Red (+) Battery connection
Probe Black (-) Battery surface (-)
 - Watch without a battery hatch:
Disassemble the holding spring for battery and the plus terminal of battery connection. Place a vinyl sheet in between the battery and the third wheel bridge to insulate electric current.
Probe Red (+) Battery surface (+)
Probe Black (-) Circuit block screw

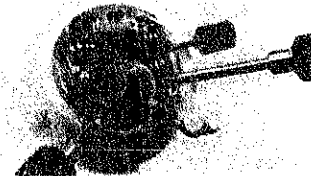
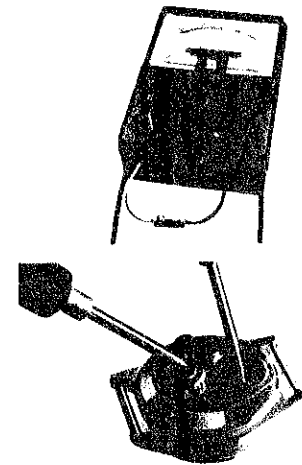

Less than 2.4 μ A →

Normal

More than 2.4 μ A →

Defective
Proceed to Check electronic circuit block

All procedures of Disassembling, Reassembling, Checking and Adjustment are completed.