

SEIKO

QUARTZ

Cal.4826A

PARTS LIST

Calibre No. <h1 style="text-align: center;">4826A</h1>	Jewels <h1 style="text-align: center;">7j</h1>	Style Name SEIKO QUARTZ WATCH WITH SOLAR POWERED CELL
--	--	--

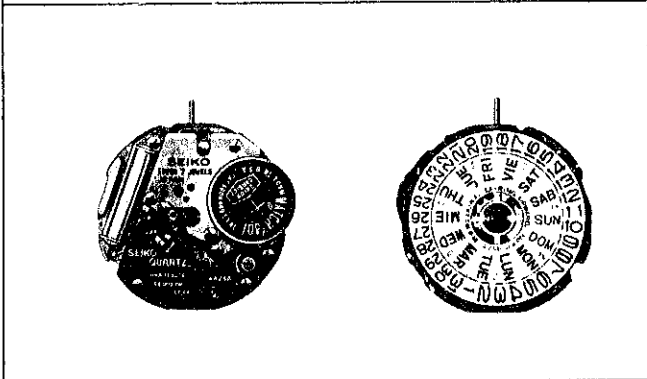

Characteristics :

Casing diameter : ϕ 25.6 mm
Maximum height : 4.8 mm
Frequency of quartz crystal oscillator : 32,768 Hz
(Hz=Hertz Cycle per second)

Driving system : Step motor system (6 poles)
Driving energy : Sunlight or artificial light energy
Regulation system : Trimmer condenser
Rapid-second adjustment : Second hand stops to the next ten-second mark

Calendar (day & date)
Instant setting device for day & date calendar
Bilingual chage-over system for day of the week
Battery recharge indicator : Second hand moving in two second intervals serves as battery life indicator

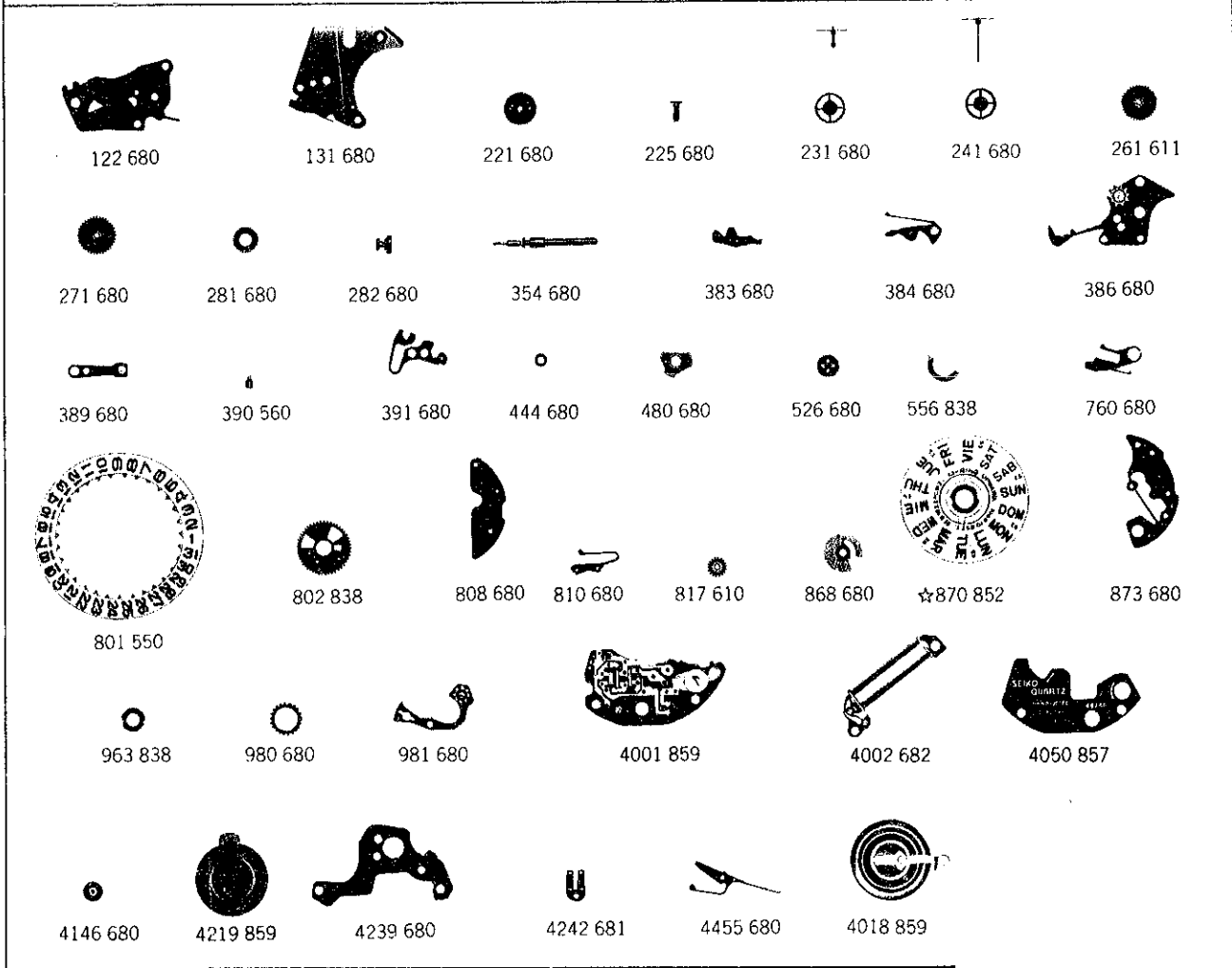

									$\frac{3}{1}$
022 282	022 468	022 753	022 761	023 029	023 033	023 436	027 904	027 908	

☆⇨ Please see remarks on the next page.

Calibre No.		Jewels	Style Name	
4826A		7j	SEIKO QUARTZ WATCH WITH SOLAR POWERED CELL	
PART NO.	PART NAME	PART NO.	PART NAME	
122 680	Center wheel bridge	011 406	Upper hole jewel for fourth wheel	
131 680	Third wheel bridge	011 411	Upper cap jewel for step rotor	
221 680	Center wheel & pinion	011 411	Lower cap jewel for step rotor	
225 680	Cannon pinion	011 411	Upper hole jewel for third wheel	
231 680	Third wheel & pinion	011 411	Lower hole jewel for third wheel	
241 680	Fourth wheel & pinion	011 424	Upper hole jewel for second setting wheel	
261 611	Minute wheel	022 282	Date driving wheel screw	
271 680	Hour wheel	022 468	Center wheel bridge screw	
281 680	Setting wheel	022 468	Third wheel bridge screw	
282 680	Clutch wheel	022 468	Circuit block screw	
354 680	Winding stem	022 468	Coil block screw	
383 680	Setting lever	022 468	Setting lever axle spring screw	
384 680	Yoke (Clutch lever)	022 468	Setting lever spring screw	
386 680	Setting lever spring	022 468	Setting wheel ring screw	
389 680	Setting lever axle spring	022 468	Screw for battery connection	
390 560	Setting lever axle	022 468	Minus lead terminal screw	
391 680	Second-setting lever	022 753	Day jumper screw	
444 680	Upper frame for hole jewel of fourth wheel	022 753	Date dial screw	
480 680	Setting wheel ring	022 761	Dial screw	
526 680	Second-setting wheel	023 029	Tube for circuit block	
556 838	Date finger	023 033	Tube for third wheel bridge screw	
760 680	Second jumper	023 436	Reset lever pin	
801 550	Date dial	027 904	Second jumper adjusting pin	
802 838	Date driving wheel	027 906	Second setting lever adjusting pin	
808 680	Date dial guard A			
810 680	Date jumper			
817 610	Intermediate date wheel			
868 680	Day finger			
☆870 852	Day star with dial disk			
873 680	Day jumper			
963 838	Snap for day star with dial disk			
980 680	Intermediate wheel for day-date correction			
981 680	Day-date corrector wheel rocker			
4001 859	Circuit block			
4002 682	Coil block			
4050 857	Circuit bridge plate			
4146 680	Step rotor			
4219 859	Insulator for battery connection			
4239 680	Rotor stator			
4242 681	Plus terminal of battery connection			
4455 680	Reset lever			
4018 859	Silver oxide battery with special treatment			

Remarks :

Day star with dial disk

☆870 852 (English ↔ Spanish)Used when both the crown and the calendar frame are located **3** o'clock position.

If any other type of day star with dial disk is required, specify the number printed on the disk.

☆↔ Please see remarks.

Part numbers in light letters are not shown in photos.

TECHNICAL GUIDE

SEIKO

QUARTZ

CAL. 4826A

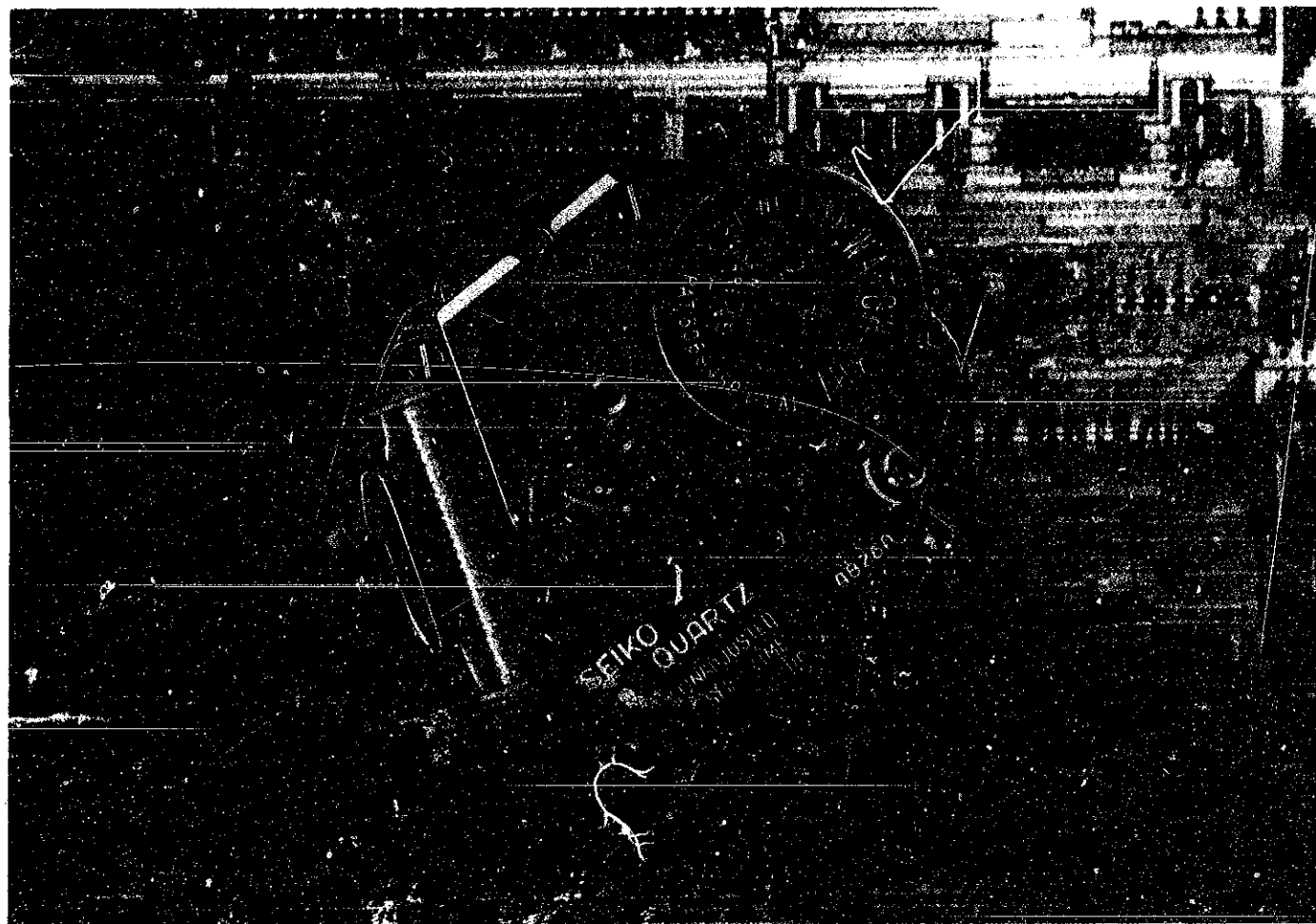

CONTENTS

I. SPECIFICATIONS AND FEATURES	2
1. Specifications	2
2. Features	2
II. FUNCTIONING	3
1. Movement structure	3
2. Functioning of solar powered cell	4
3. Outline of functioning	5
4. Functioning of electronic circuit block	5
5. Functioning of mechanical portion	7
III. HOW TO SET THE TIME AND CALENDAR	9
1. To set the time	9
2. To set the calendar	9
IV. AFTER-SALE SERVICING INSTRUMENTS AND MATERIALS	10
1. Quartz Tester	10
2. Micro Test MT-10II	10
3. Volt-ohm-meter	10
4. Movement holder (S-651)	10
5. Others	10
V. DISASSEMBLING, REASSEMBLING, LUBRICATING AND CLEANING	11
1. Disassembling, reassembling and Lubricating	11
(1) Disassembling, reassembling and lubricating of the case back ~ battery with special treatment	11
(2) Disassembling, reassembling and lubricating of the calendar and setting mechanism	12
(3) Disassembling, reassembling and lubricating of the circuit block, coil block and movement	14
(4) Disassembling, reassembling and lubricating of the setting mechanism	16
2. Cleaning	17

VI. CHECKING AND ADJUSTMENT	19
1. Guide table for checking and adjustment	19
2. Procedures for checking and adjustment	20
A. Check charging of battery	20
B. Check output signal	20
C. Check voltage of battery with special treatment	20
D. Check solar cell	22
E. Check current consumption	22
F. Check conductivity of battery with special treatment	22
G. Check reset switch	24
H. Check conductivity of circuit block	24
I. Check conductivity of circuit block output terminal	24
J. Check coil block	26
K. Check output signal	26
L. Check second setting lever	26
M. Check second jumper	28
N. Check second setting condition	28
O. Check reset condition	30
P. Check accuracy	32

SEIKO Quartz watch with solar powered cell Cal. 4826A is a revolutionary solar energy-powered quartz crystal watch. It is equipped with a solar cell that converts the light energy into the electrical energy, which in turn is charged into the silver oxide battery for operating the watch.

Calibre 4826A

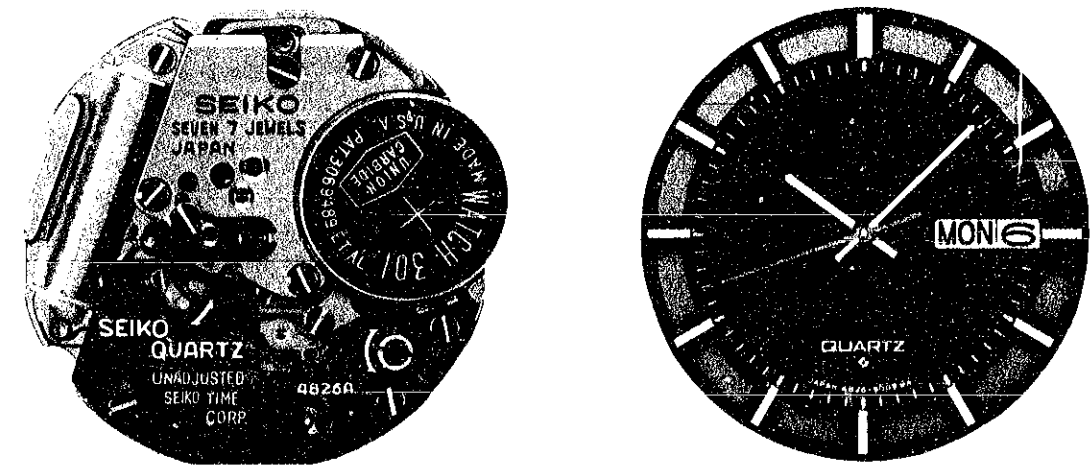

Movement (with a dial)

I. SPECIFICATIONS AND FEATURES

1. Specifications

Item	Cal. No. 4826A
Additional mechanism	Calendar (day & date) Bilingual change-over system for the day of the week Instant day and date setting Electronic circuit reset switch
Rapid advance second setting adjustment	Second hand stops to the next ten-second mark
Battery recharge indicator	Second hand moves in two-second intervals
Crystal oscillator	32,768 Hz (Hz = Hertz . . . Cycles per second)
Loss/gain	Loss/gain at normal temperature Monthly rate: less than 10 seconds (Annual rate: less than 2 minutes)
Casing diameter	φ25.6 mm
Height	4.8 mm
Operational temperature range	-10°C ~ +60°C (14°F ~ 140°F)
Driving system	Step motor system (6 poles)
Regulation system	Trimmer condenser
Over-voltage recharging control device	Recharging control circuit
Battery power	Primary battery: Silicon solar cell, 10 sheets Secondary battery: Silver oxide battery with special treatment
Jewels	7 jewels

2. Features

1. Incorporated in the SEIKO Quartz watch with solar powered cell, Cal. 4826A, is exactly the same highly accurate and reliable mechanism for which Cal. 4823A has been known. What has been added is a solar powered-cell which enables the secondary battery life to be expanded to approximately 10 years, thereby eliminating the troublesome battery replacement procedures.
2. As the battery power nears its end, the second hand starts moving at two second intervals instead of the normal one second interval. With this indication there is no need to be concerned as to when the solar cell should be recharged.
3. SEIKO's unique recharge control circuit in Cal. 4826A most effectively controls recharging of the secondary battery and at the same time protects it against overcharging.
4. After-sale services can be offered as easily for this watch as for the other SEIKO Quartz watches.

II. FUNCTIONING

1. Movement structure

The movement consists of the circuit block, coil block, battery with special treatment and the mechanical portion, of which the main components are a step motor and a gear train. Since each portion is a separate unit, easy checking, servicing and adjustment are possible.

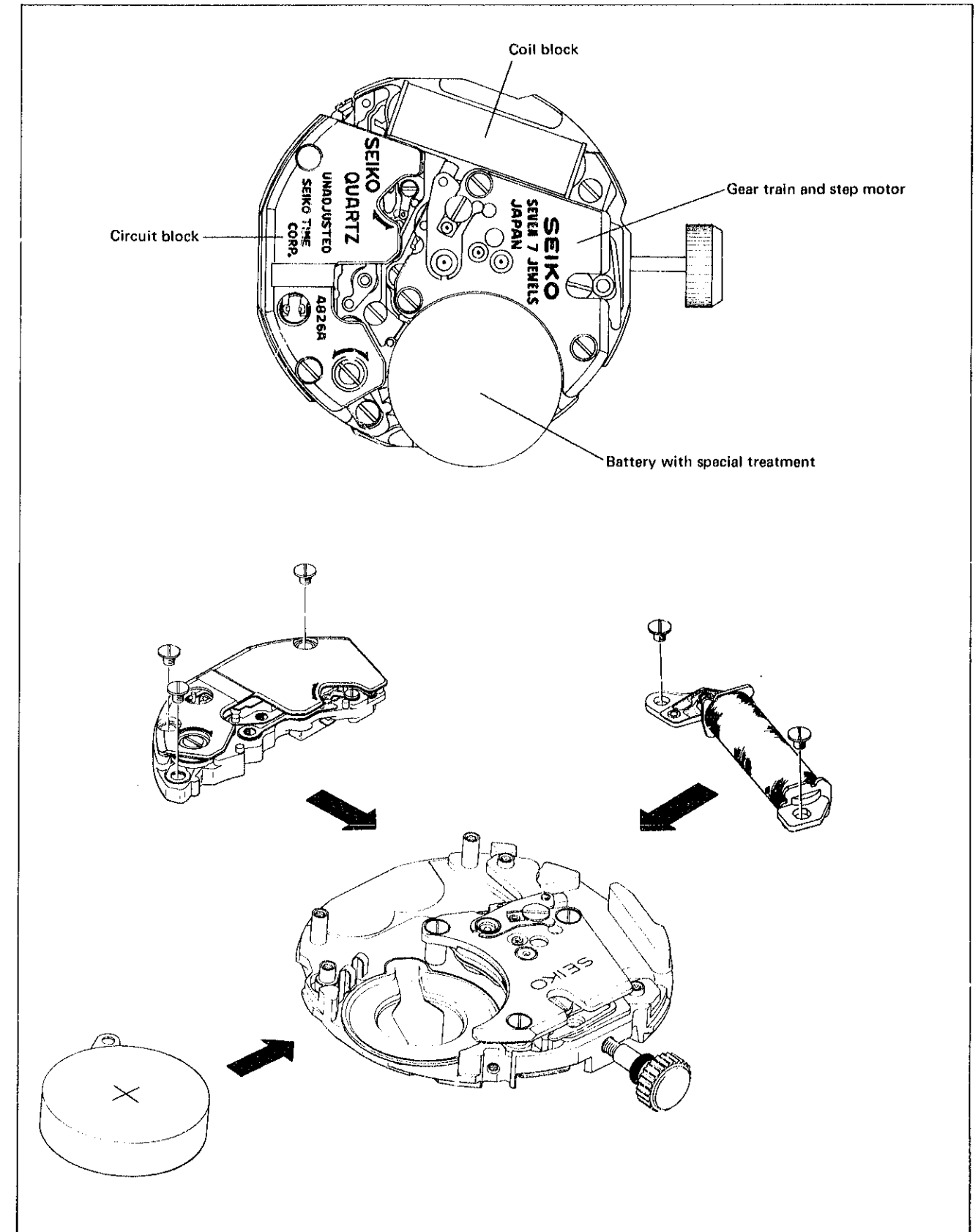

2. Functioning of solar powered cell

- (1) The solar cell placed in the dial converts light energy such as sunlight energy, etc. into electrical energy. The electrical energy thus obtained is supplied to the movement through the recharge control circuit and the secondary battery with special treatment.
- (2) The recharge control circuit, always checking the voltage of the battery with special treatment, quickly recharges the electrical energy in the battery with special treatment from the solar cell when the battery with special treatment is short of electrical energy. When the voltage of the battery with special treatment becomes high indicating it is filled with electrical energy, the recharge control circuit stops recharging the battery with special treatment.

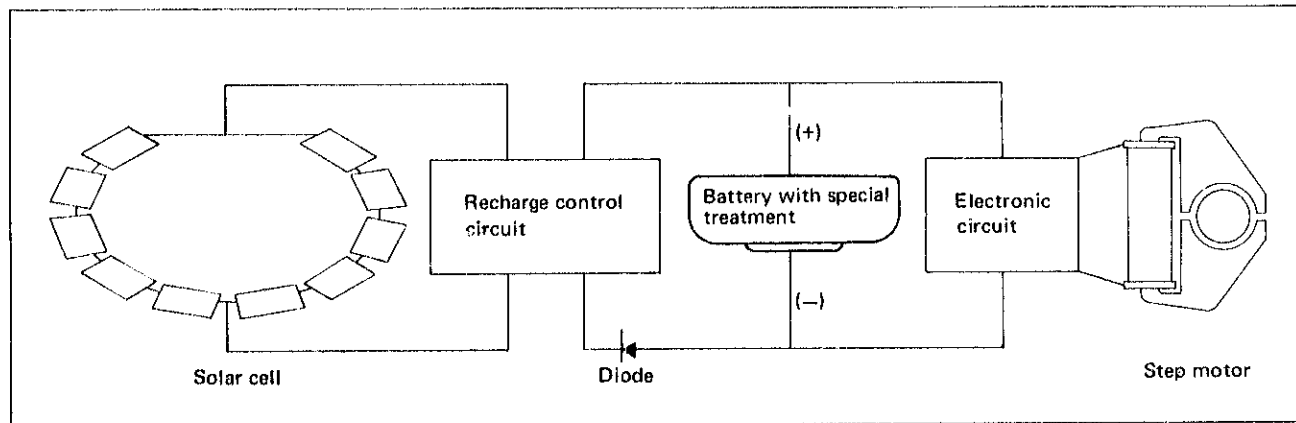

• Dial structure

The dial is constructed in layers as shown in the illustration below. First comes the dial lower plate, then the minus terminal of the battery connection, 12 sheets (2 sheets of which are dummies) of solar cells and finally the dial plate with open frame for solar cells. Each of the 5 solar cells is arranged in a series on the 12 o'clock side and the 6 o'clock side, and the two 5-solar cells are arranged in parallel so that the current and voltage needed for recharging the battery with special treatment can be transmitted.

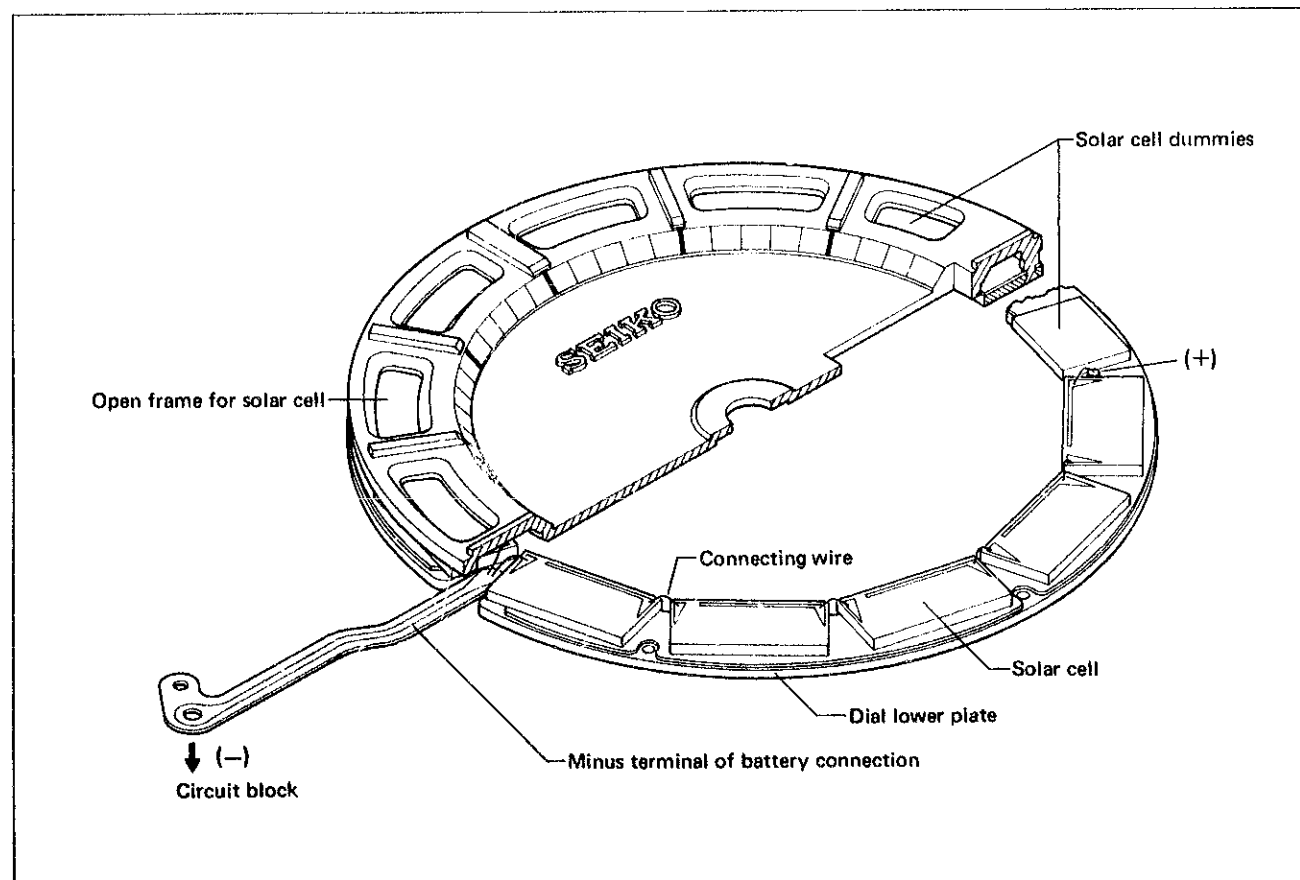

3. Outline of functioning

- (1) The quartz crystal oscillator, built into the crystal unit, oscillates accurately at 32,768 Hz.
- (2) The circuit unit receives the 32,768 Hz oscillations (electronic signals) and converts them into impulses at the rate of one per second, i.e. 1/2, 1/2, 1/2 . . .
- (3) The one-per-second signals are transmitted to the coil block, causing the step motor to rotate once every second in 60° increments.
- (4) This rotation is transmitted to the gear train thus moving the hands.

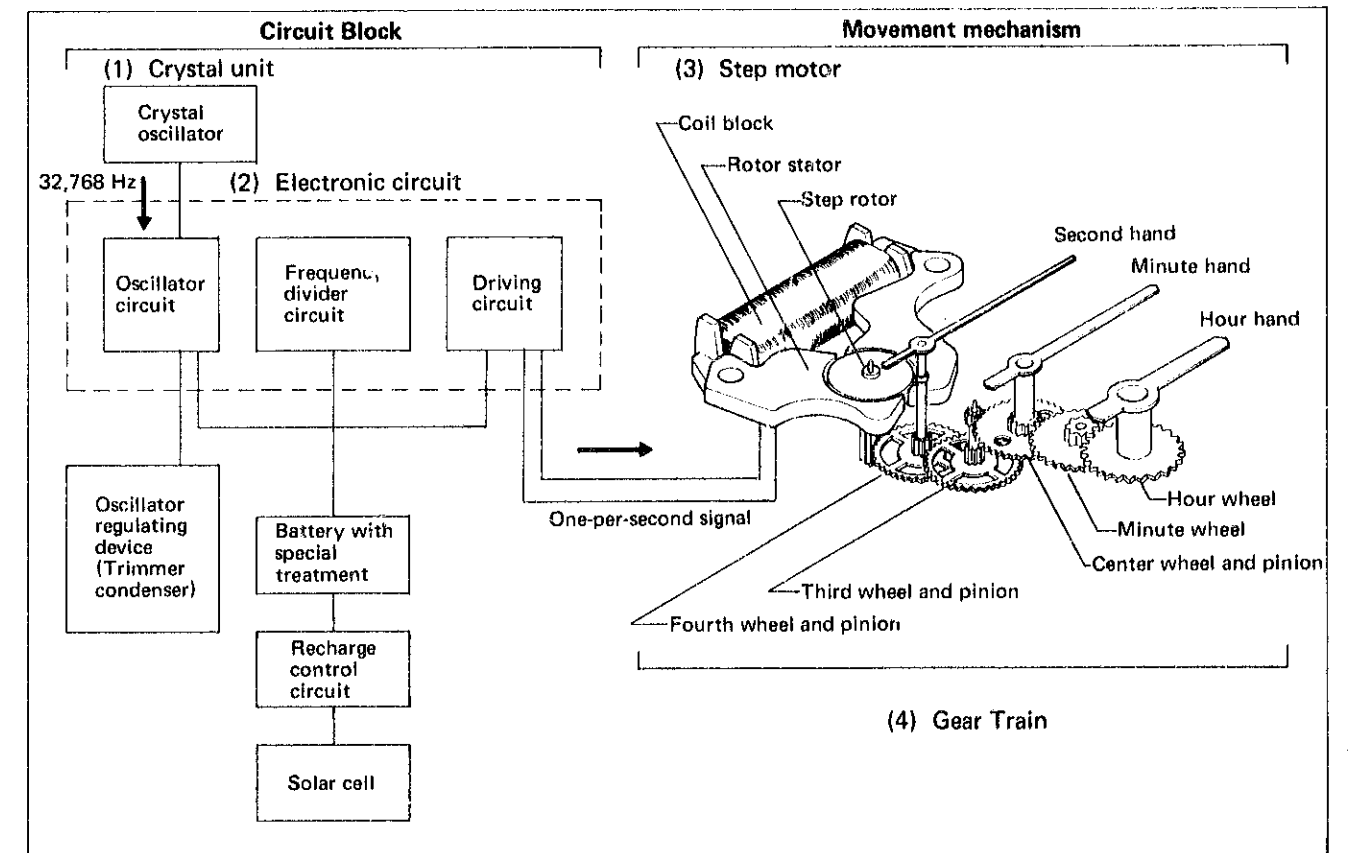

4. Functioning of electronic circuit block

(1) Circuit block

• The quartz crystal oscillator uses the SEIKO ultra-small tuning fork shape and is housed in a flat-type vacuum capsule.

When voltage is supplied from the electronic circuit, the crystal oscillator makes stabilized oscillations exactly at 32,768 Hz which is the source of the high accuracy obtained in Cal. 4826A watch.

• A MOS IC of high reliability is used in the electronic circuit. The electronic circuit supplies voltage to the crystal oscillator which causes it to oscillate at 32,768 Hz and at the same time it receives the oscillation in the form of an electrical signal. The oscillation of 32,768 Hz is divided into 1/2 successively to finally obtain a signal per second, which is transmitted to the step motor.

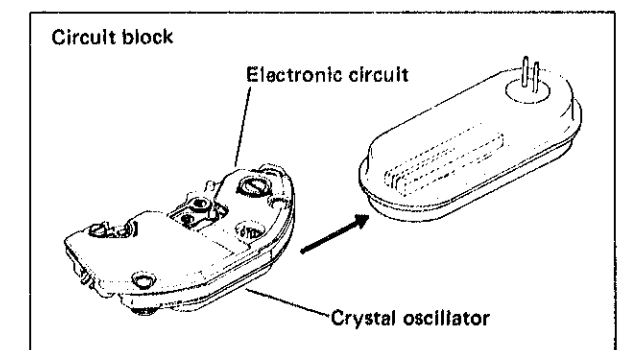

(2) Oscillator regulating device

Adjustment of the oscillator of Cal. 4826A watch can be easily made by simply turning the trimmer condenser.

● **Function of the Trimmer Condenser**

The trimmer condenser consists of a rotor electrode and a stator electrode. Turning the shaft fixed to the rotor changes the overlapped area between the rotor electrode and stator electrode, which in turn changes the capacitance of the trimmer condenser. Turning the trimmer condenser changes its capacitance as shown in the diagram. Time is adjusted by the magnitude of this change.

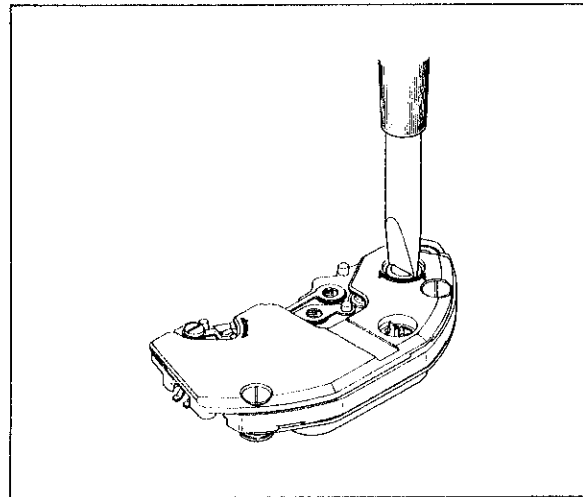

○ Checking accuracy cannot be made with conventional mechanical watch timing machines. It is necessary to use the QUARTZ TESTER.

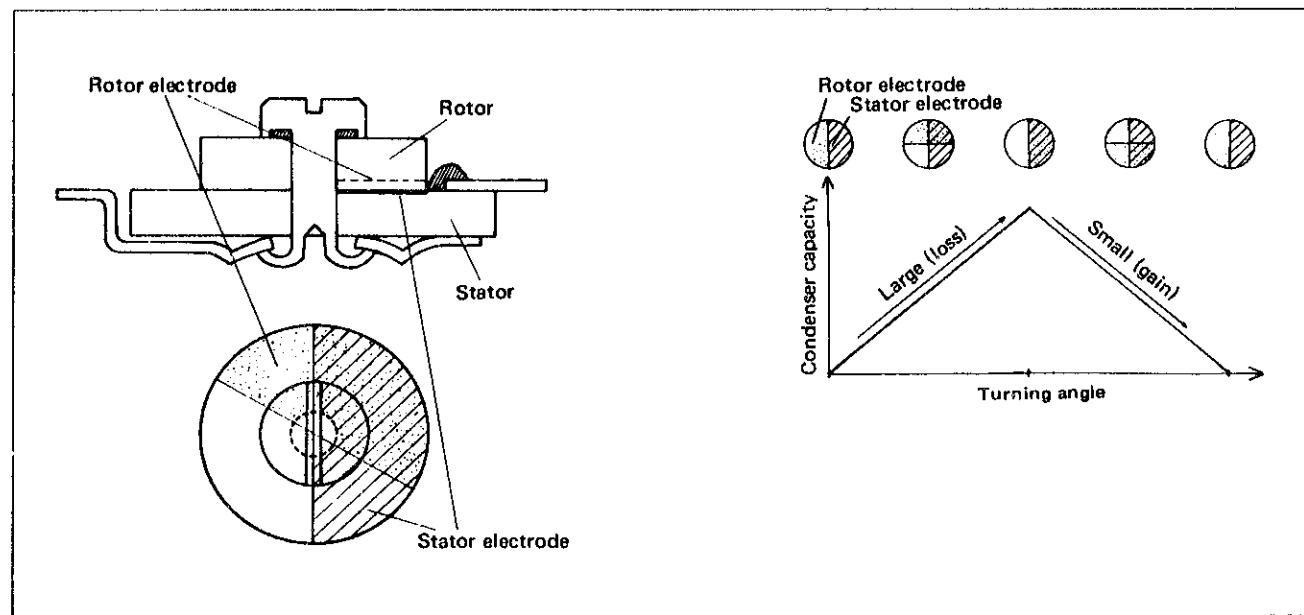

5. Functioning of mechanical portion

(1) Step motor

One of the features of these watches is the SEIKO step motor which changes the vibrations of the crystal oscillator into a rotating motion. The step motor consists of a coil block, a rotor stator and a step rotor. The rotor stator is made of materials having a high conductivity of magnetic force. The step rotor is a circular-shaped permanent magnet having six alternately imposed N and S poles.

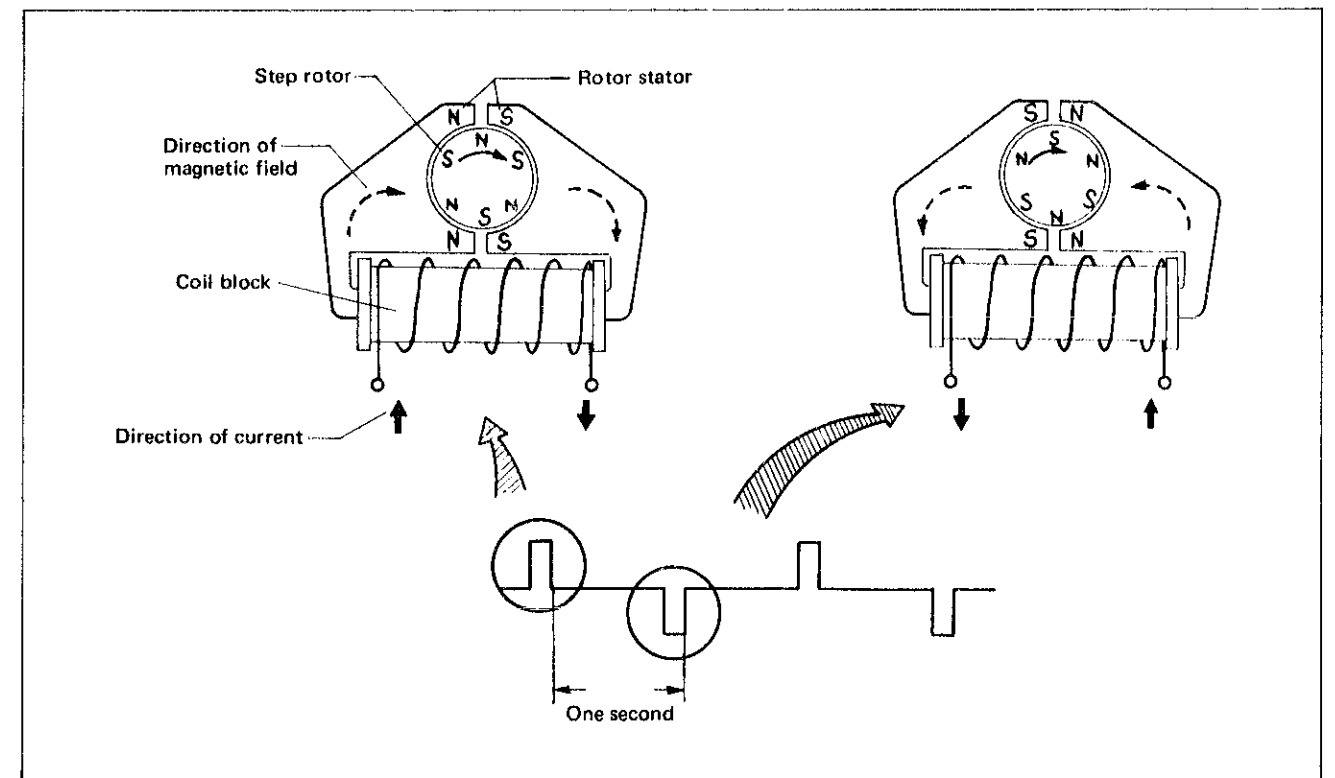
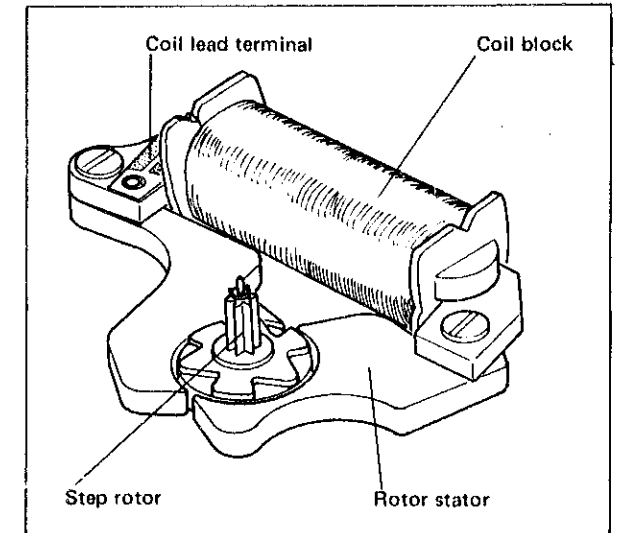

Operational sequence

- (1) **Current flows into the coil block**
The current, of which the flow direction is changed once every second, is transmitted from the circuit block into the coil block
- (2) **Rotor stator becomes magnetized**
When current flows in the coil block, the rotor stator becomes magnetized and the tip portions become, respectively, N and S poles.
- (3) **Step rotor rotations**
The N and S poles of the rotor stator tips and the N and S poles of the step rotor alternately repel and attract causing the step rotor to rotate in 60° increments in a constant direction once every second.
- (4) **Rotation of the second hand**
Rotation of the step rotor is transmitted to the fourth wheel and pinion which gears with the pinion of the step rotor. The rotation of the fourth wheel and pinion is finally transmitted to move the second hand.

(2) Second setting and reset switch

Cal. 4826A has the rapid advance second setting adjustment device and the reset switch for accurate time setting and second hand can be set rapidly and accurately in accordance with a time signal.

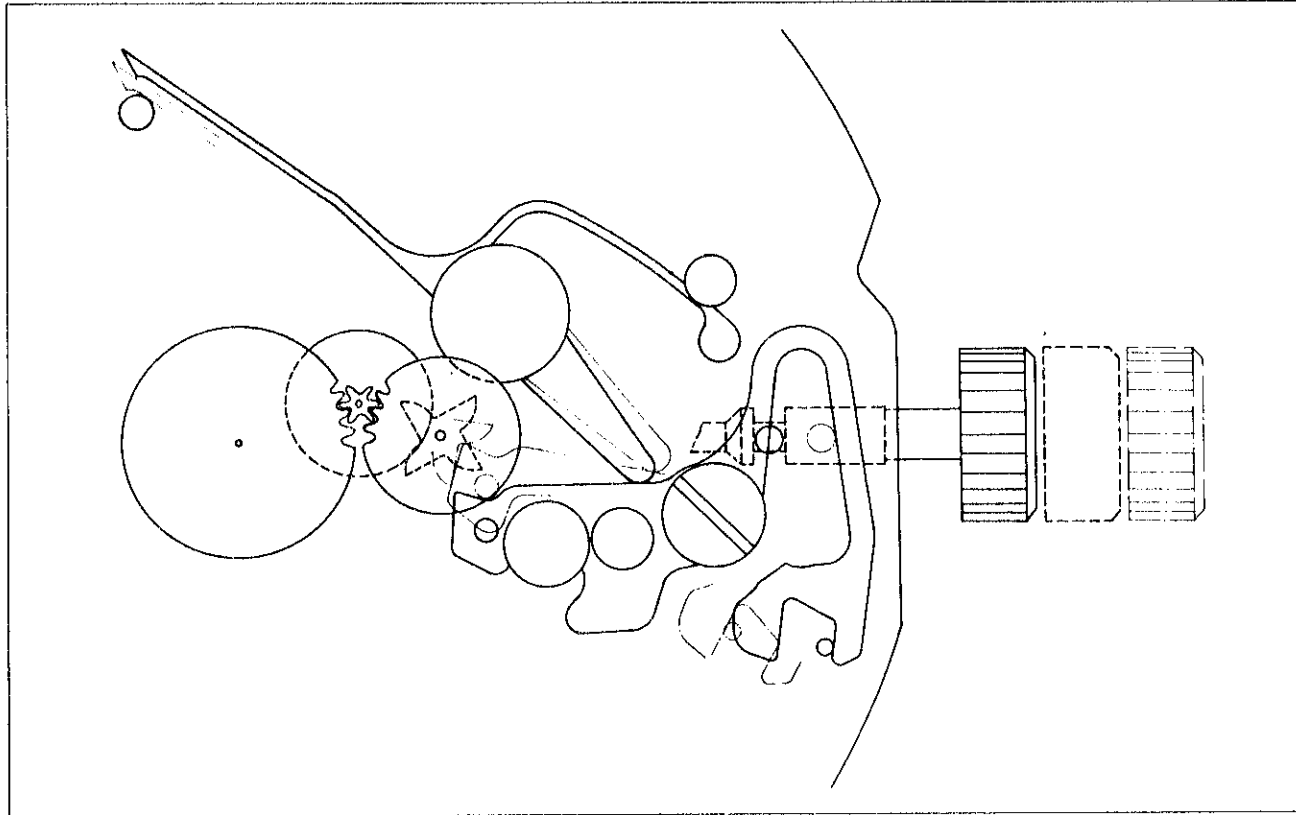

• Rapid advance second setting adjustment

When the crown is pulled out to the 2nd click, the driving pin for second setting lever will function to reset the cam of the second setting wheel. Thus, the second hand will stop at every 10 second position ahead (0, 10, 20, 30, 40, 50 second).
Ex. If the crown is pulled out to the 2nd click when the second hand is between 51 to 0 second position, the second hand will leap and stop at 0 second position.

• Reset switch

When the second setting lever functions and the second hand stops, the reset lever touches the circuit block reset pin and reset function starts.

The watch stops when the reset switch functions but the current from the battery flows to the crystal oscillator and a part of the electronic circuit and the watch is ready to restart.

III. HOW TO SET THE TIME AND CALENDAR

• Crown position

- Normal position: Free
- 1st click: Change of day and date
 - Date change . . . clockwise (turn away from you.)
 - Day change . . . counterclockwise (turn towards you.)
- 2nd click: Hand setting, reset switch and second setting

1. To set the time

- (1) Pull the crown out to the 2nd click and the second hand stops at the 10 second position ahead.
- (2) Turn the crown and set the time of the hour hand and minute hand.
 - First turn the hour hand past the 12 o'clock position until the date changes, then set the time correctly. (Allow for the A.M. & P.M. period so that the date will change at midnight.)
 - As the torque of the great train is transmitted reversely, the time is set accurately by turning the hands between 5 to 10 minutes ahead and then turning it back to the desired time.
- (3) In accordance with the time signal, push the crown in. Rapid second adjustment facilitates easy time adjustment in accordance with the time signal of TV, radio and telephone.
Push the crown in to the innermost position to start the watch. Then the hour, minute and second hand will be set exactly.

2. To set the calendar

- Pull the crown out to the 1st click.

Select the desired language as two languages appear alternately when setting the day of the week. If the setting of the calendar is made when the hands are pointing to the time between 9:30 p.m. and 2:00 a.m., sometimes the calendar will not change the next day. The setting must therefore should be made before or after this time period.

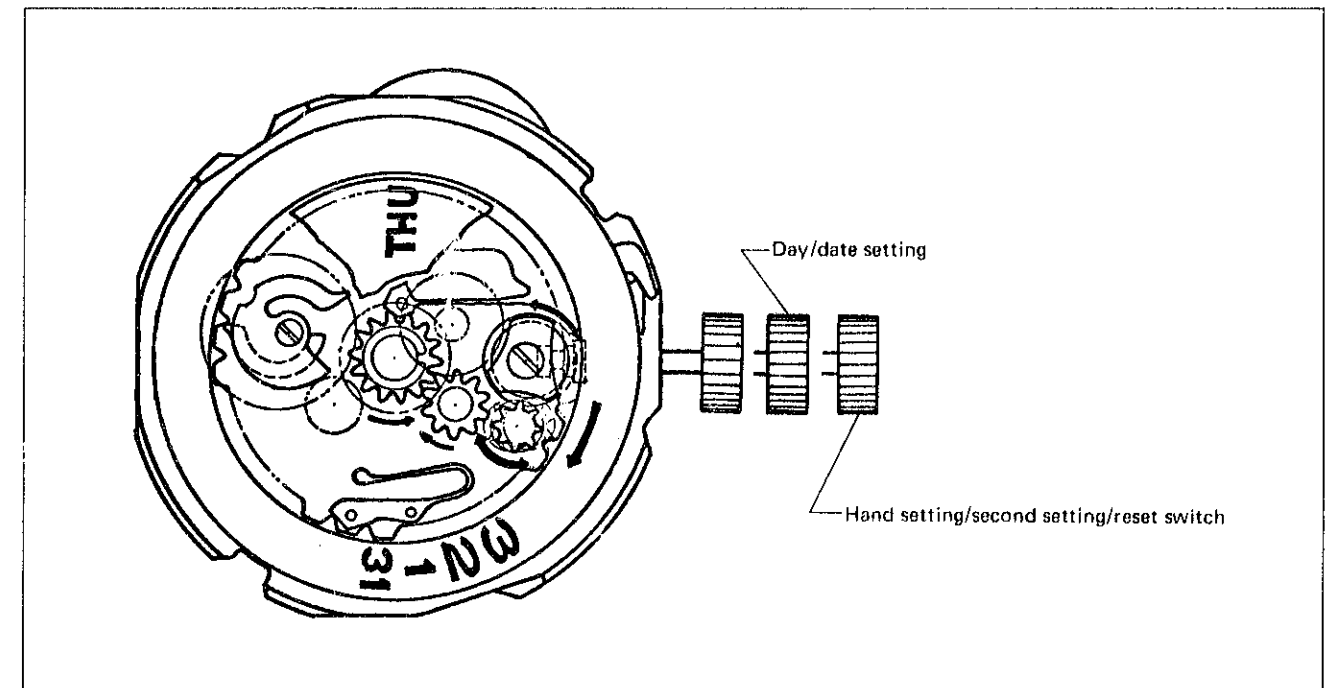

IV. AFTER-SALE SERVICING INSTRUMENTS AND MATERIALS

For repair servicing, the following SEIKO after-sale servicing instruments and materials are necessary.

1. Quartz Tester

Used to check time accuracy (daily rates).

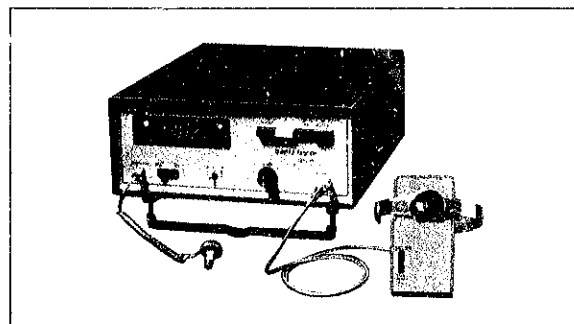

2. Micro Test MT-10 II

Used to check the current consumption and the flow of the voltage power constantly.

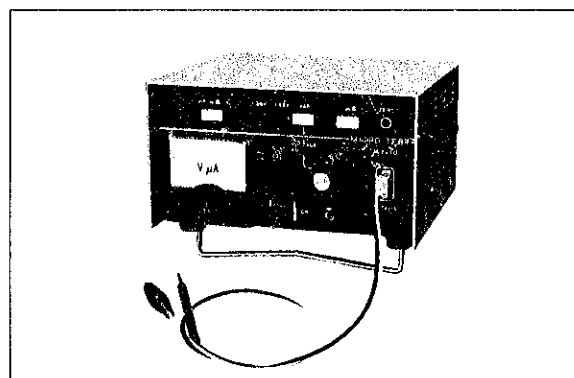

3. Volt-ohm-meter (S-831)

Used for checking battery voltage, measuring resistance and conducting conductivity test.

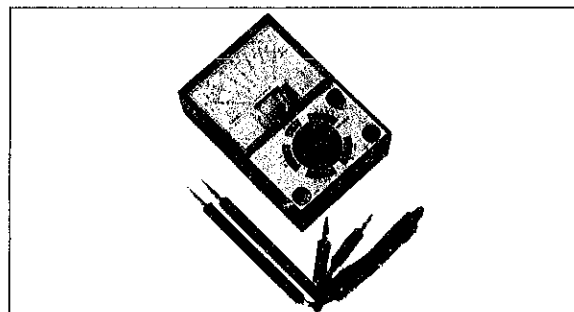

4. Movement holder (S-651)

Used for disassembling, reassembling, checking and adjusting the movement.

Note: Before handling the movement with the dial, be sure to cut the side of the movement holder opposite the groove for winding stem with crown with a knife as shown in the illustration below so that the minus terminal of battery connection does not touch the movement holder.

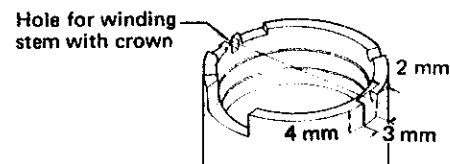
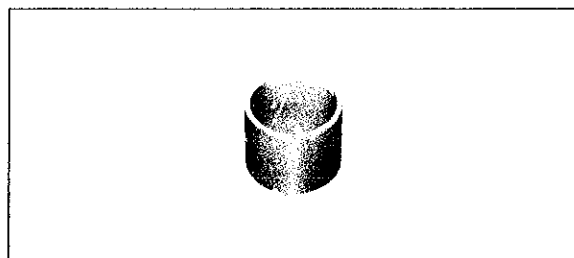

5. Others

- (1) Anti-magnetic tweezers for handling step rotor.
- (2) Non-metallic tweezers for handling battery.

V. DISASSEMBLING, REASSEMBLING, LUBRICATING AND CLEANING

1. Disassembling, Reassembling and Lubricating

Disassembling and Reassembling

Disassembling procedures Figs.: ①→⑤③

Reassembling procedures Figs.: ⑤③→①

- Lubricating
The following symbols in the diagrams indicate types of oil, quantities to be applied and lubricating points.

Types of oil

- Moebius A
- SEIKO Watch Oil S-6

Oil quantity

- Liberal
- Normal
- Extremely small

Never lubricate portions marked ⊗

- For the items marked with ▶ in remarks for disassembling and reassembling, refer to "CHECKING AND ADJUSTMENT".

(1) Disassembling, reassembling and lubricating of the case back ~ battery with special treatment.

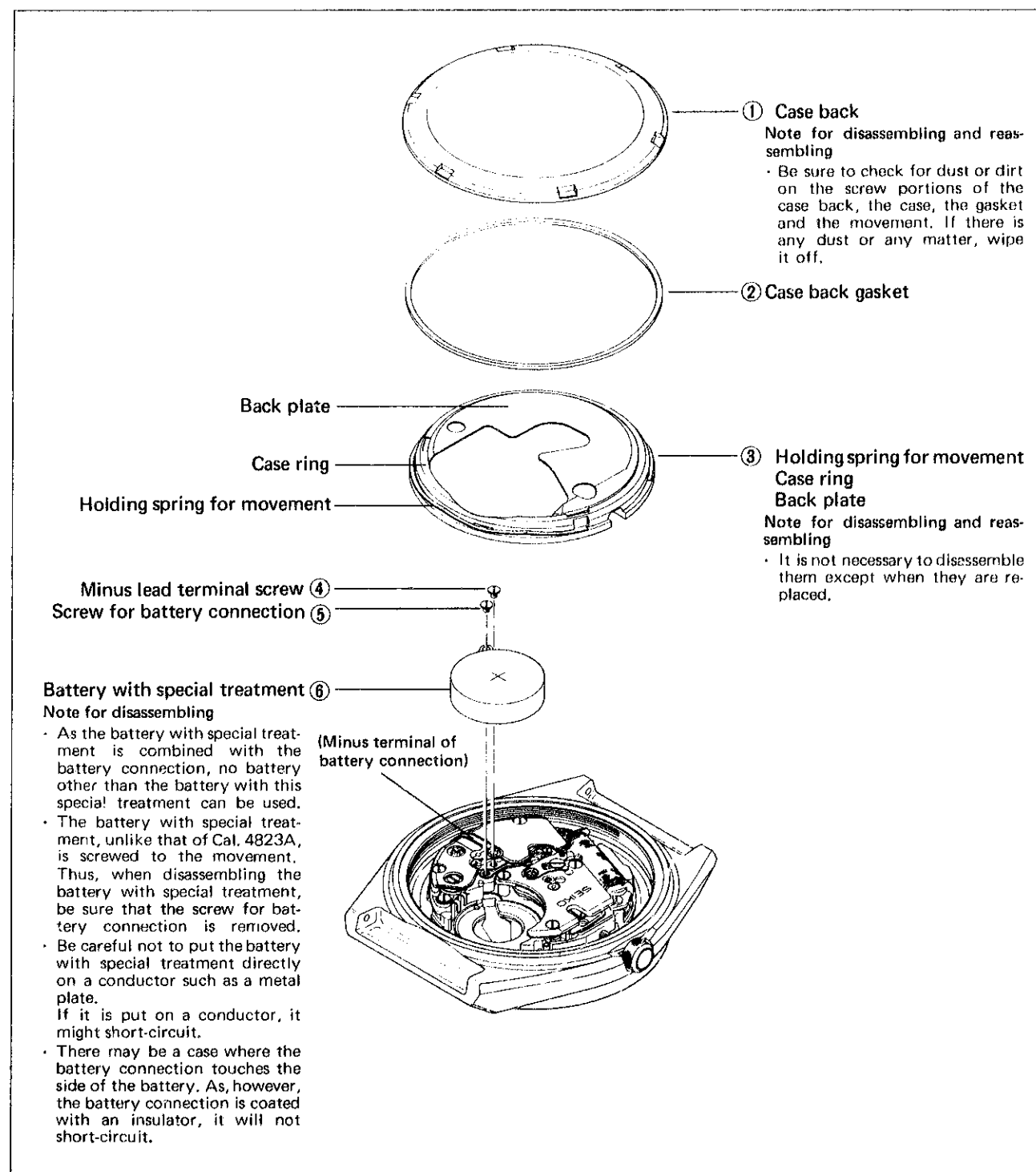

(2) Disassembling, reassembling and lubricating of the calendar and setting mechanism

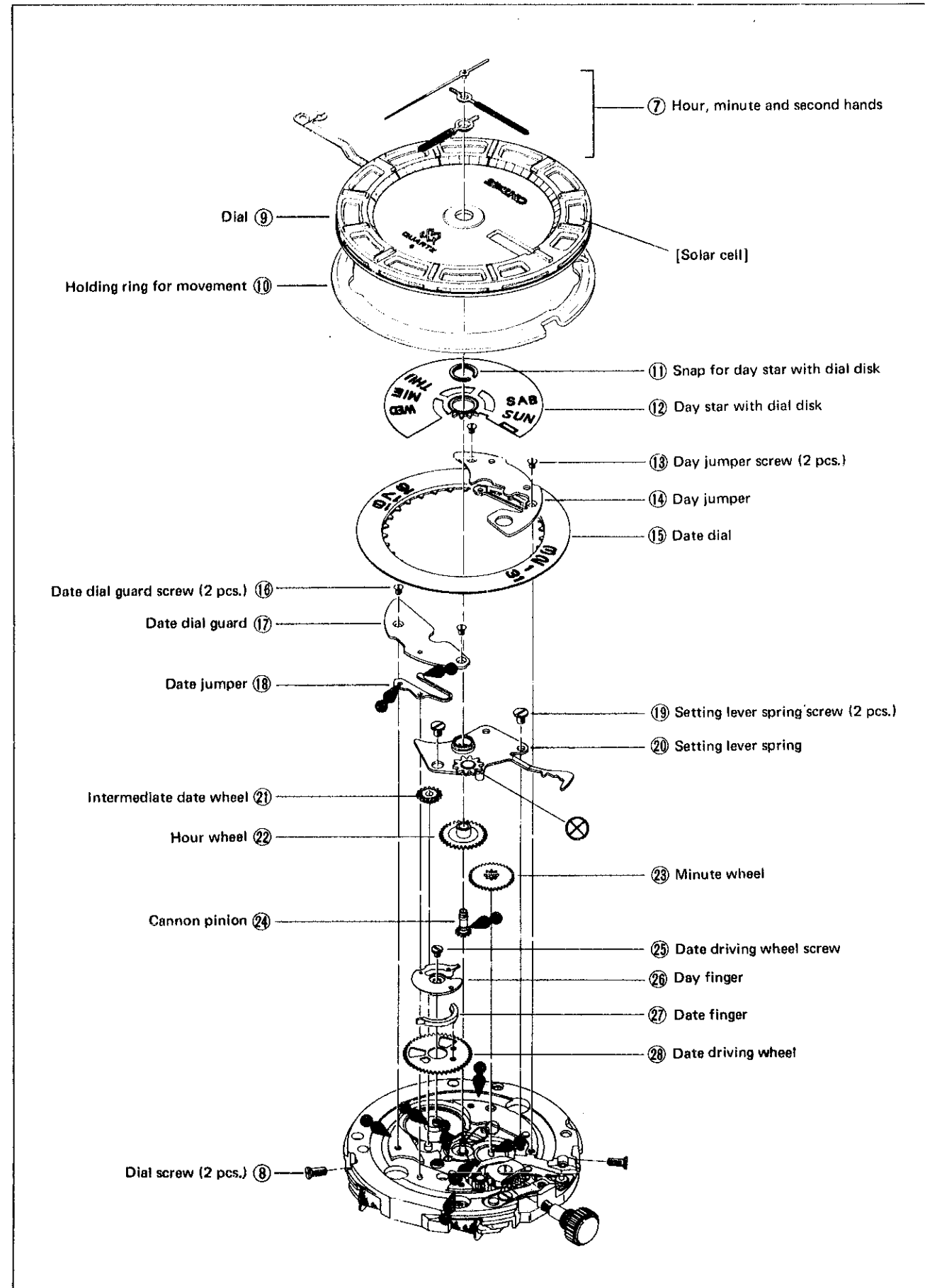

Remarks for disassembling and reassembling:

Hour, minute and second hands ⑦

- (1) Pull out the crown to the 2nd click before putting on or removing the hands.
- (2) Put the second hand just on the ten-second mark (0, 10, 20 . . . 50 sec.).
- (3) After placing the second hand, follow the procedures:

- ▶ **N** CHECK SECOND SETTING CONDITION and
- ▶ **Q** CHECK RESET CONDITION.

Dial ⑨ and holding ring for movement ⑩

- (1) Be careful not to damage the solar cell.
- (2) Be careful not to bend the minus terminal of the battery connection.
- (3) Be sure to combine the dial and the holding ring for movement beforehand so that they are reassembled in the movement easily. Make sure to reassemble the minus terminal of the battery connection in such a way that it comes inside the cut of the holding ring for movement as shown in the illustration.

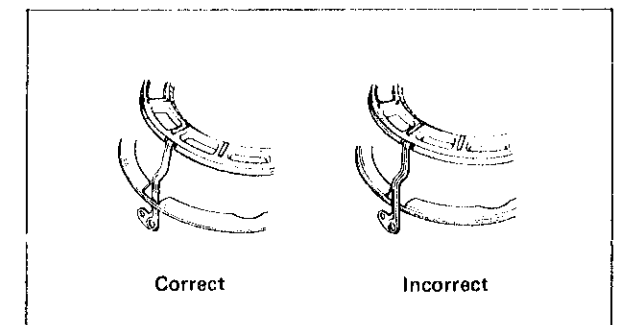

Setting lever spring ⑳

- (1) After reassembling check the crown condition (operation by pulling out and pushing in), reset conditions, hand-setting conditions.
- (2) Intermediate wheel for day correction (it is touching the setting lever spring.)

Hour wheel ㉒

Reassembling the hour wheel so that it doesn't touch the day finger.

Date driving wheel ㉘

In reassembling, do not mistake the obverse and reverse for each other.

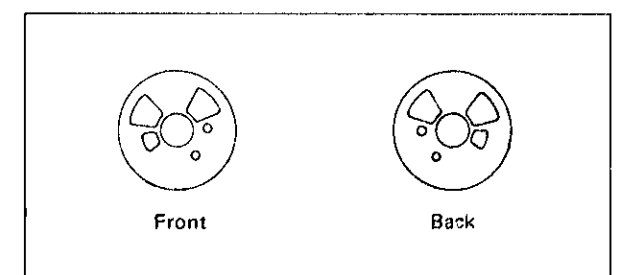

(3) Disassembling, reassembling and lubricating of the circuit block, coil block and movement mechanism

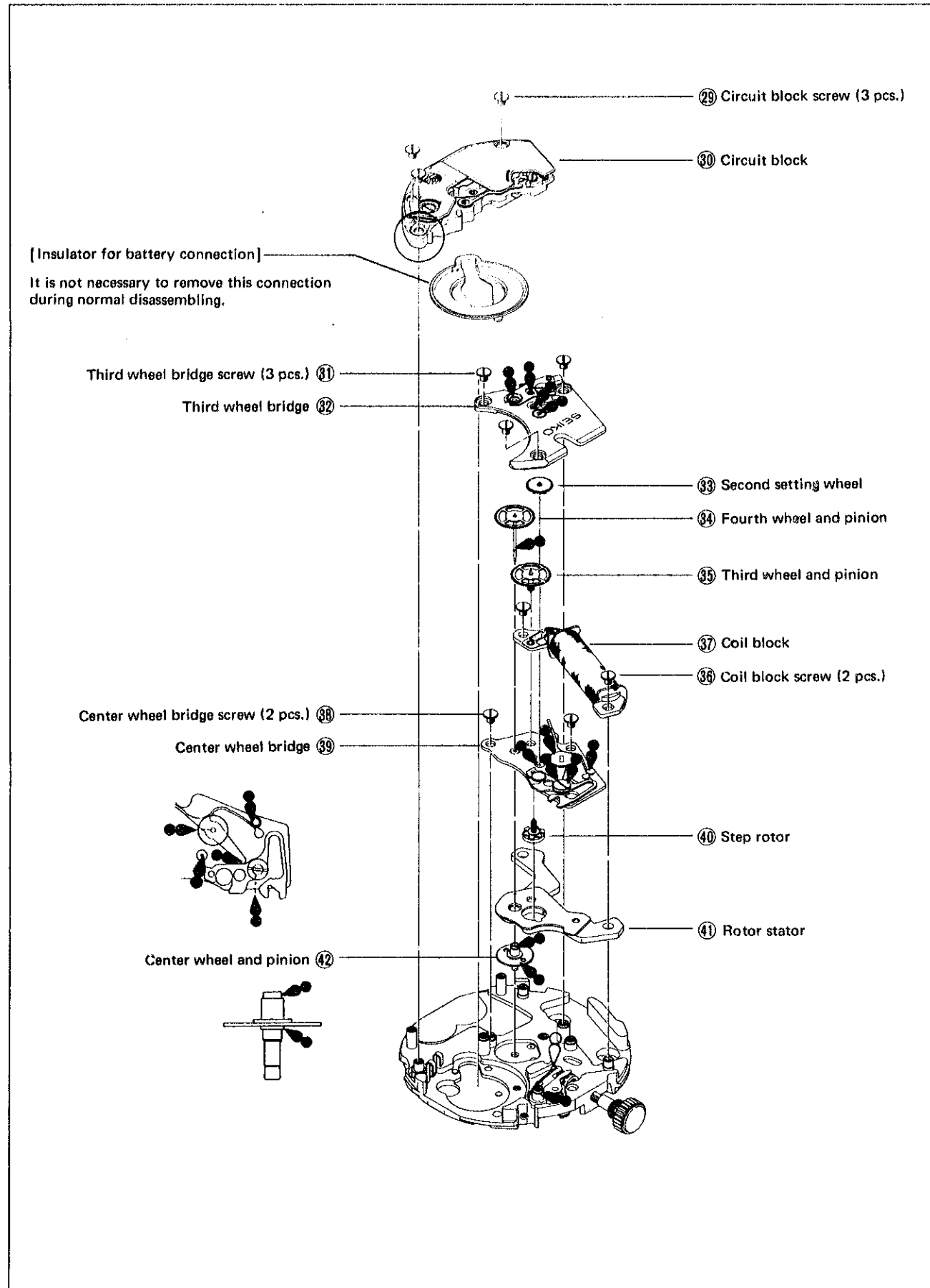

Remarks for disassembling and reassembling

Circuit block 30

- (1) Do not disassemble the circuit block.
- (2) Keep the crown at the normal position.
- (3) Before reassembling, check to see that the insulator for battery is in position.
- (4) Hold the portion in mark \bigcirc when handling.
- (5) For reassembling, be sure to set the MOS IC plus terminal (arrow-marked portion appearing on the back of the circuit block) in the pin on the main plate.
- (6) After reassembling, proceed to the following checking and adjustment.
 - Check the position of polarity change-over switch.

(Refer to CHECK RESET CONDITION)

- CHECK CIRCUIT BLOCK OUTPUT TERMINAL CONDUCTIVITY

Third wheel bridge 32

- (1) After reassembling, proceed to the following checking and adjustment.
 - ▶ Check second jumper
 - ▶ Check second setting lever

The second jumper touches the third wheel bridge.

- (2) Keep the crown at the normal position.
- (3) It is not necessary to remove the second jumper adjusting pin.
- (4) When assembling, be careful not to bend the setting lever so that it touches the fourth wheel.

Second setting wheel 33

- (1) Push in the crown to the normal position.
- (2) Reassemble the second setting wheel with its cam turned down. (in a downward position)

Coil block 37

Be careful not to scratch the coil wire and lead terminal. Handle as shown in the photo on the right.

Center wheel bridge 39

- The second setting lever and the reset lever are combined with the center wheel bridge.
- (1) Do not hold the second setting lever and the reset lever with a tweezers, or they will be damaged.
- Second setting lever adjusting pin
- (2) Do not remove it as it is not a screw.

Step rotor

- (1) Use an anti-magnetic tweezers.
- (2) Do not keep the step rotor together with other parts.
- (3) Before reassembling, wipe off filings and dust completely around the rotor stator and step rotor.

Rotor stator 41

Be careful not to damage the rotor stator. Before reassembling, set the yoke into the groove of the clutch wheel.

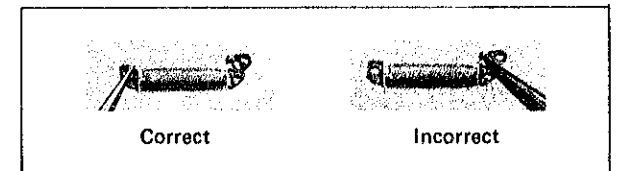
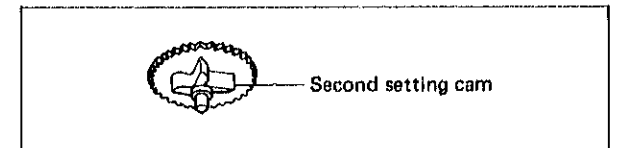
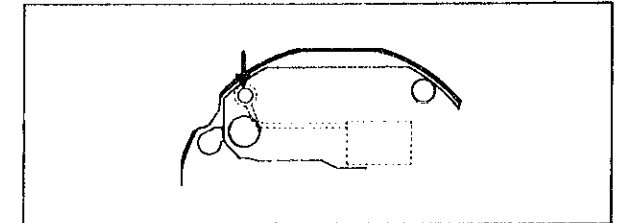



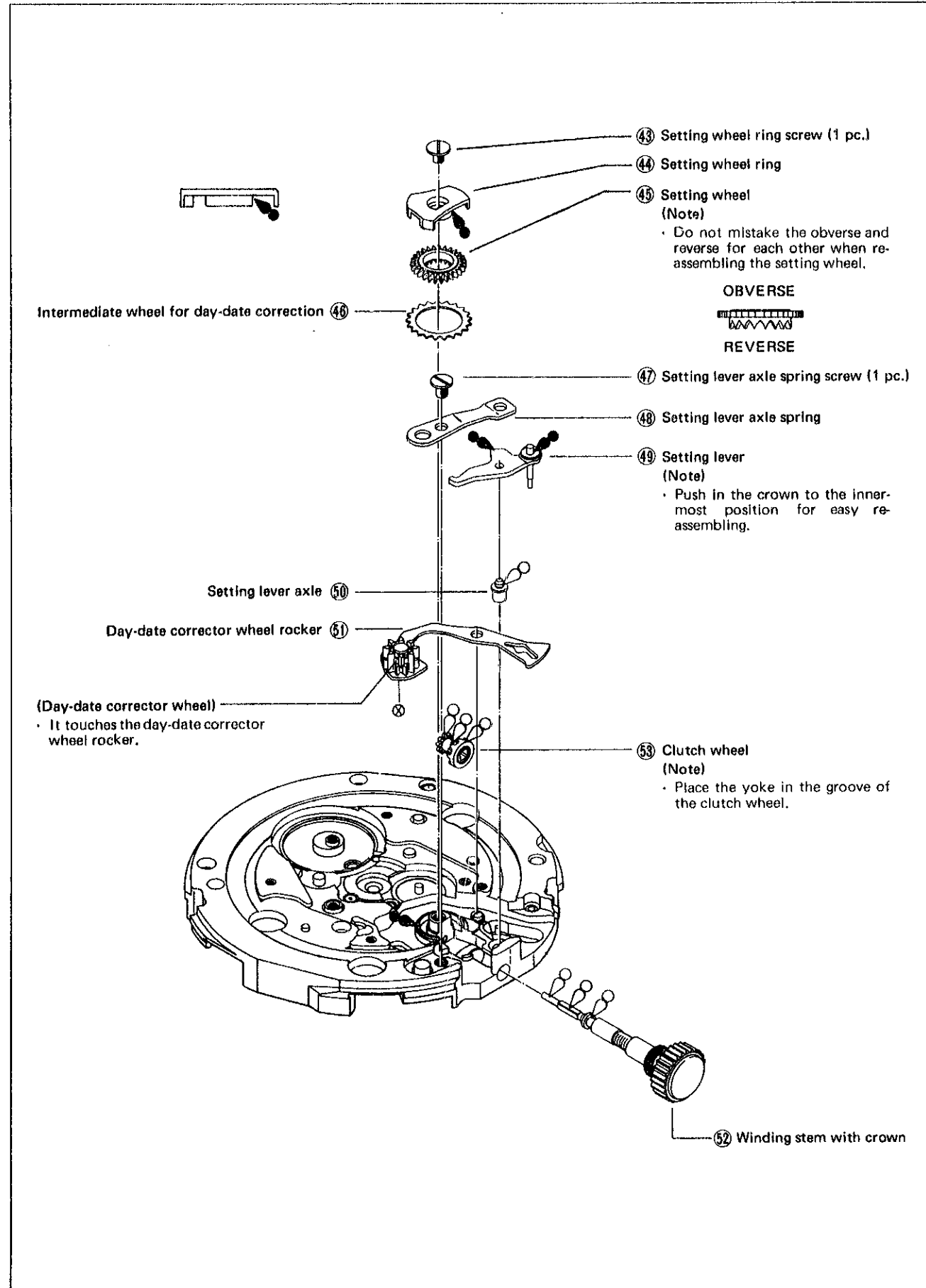

(4) Disassembling, reassembling and lubricating of the setting mechanism

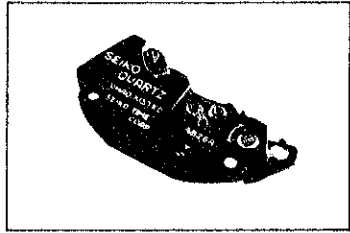
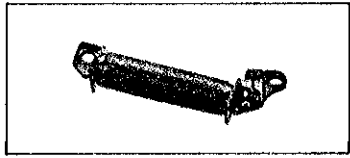

2. Cleaning

Since several special parts (electronic, plastic, etc.) are used in the Cal. 4826A, use the following checking methods when cleaning.

HOW TO CLEAN

Name of parts	Cleaning	Drying	Solution	Remarks
(1) Circuit block  Coil block 	DO NOT CLEAN			Conductive portion ONLY may be cleaned with a cloth moistened with benzine, or alcohol. Dry in COOL air.
(2) Main plate  Center wheel bridge  Third wheel bridge  Step rotor 	Rinse or scrub with a brush	Cool air drying	Benzine	<ul style="list-style-type: none"> • Be careful not to bend or remove the parts fixed to the main plate, center wheel bridge and third wheel bridge. • The main plate can be cleaned with trichloroethylene after removal of insulator for battery connection. • Use a clean solution as the step rotor has a magnet. Any foreign matter which cannot be removed by cleaning should be removed with adhesive tape or scotch tape.
(3) Plastic parts	Rinse or scrub with a brush	Cool air drying	Benzine, alcohol	• When cleaning with benzine, the cleaning time should be minimized.
(4) Others	Clean with cleaner, rinse or gently scrub with a brush.	Cool or hot air drying	Benzine, trichloroethylene	• Be careful not to bend the rotor stator.

VI. CHECKING AND ADJUSTMENT



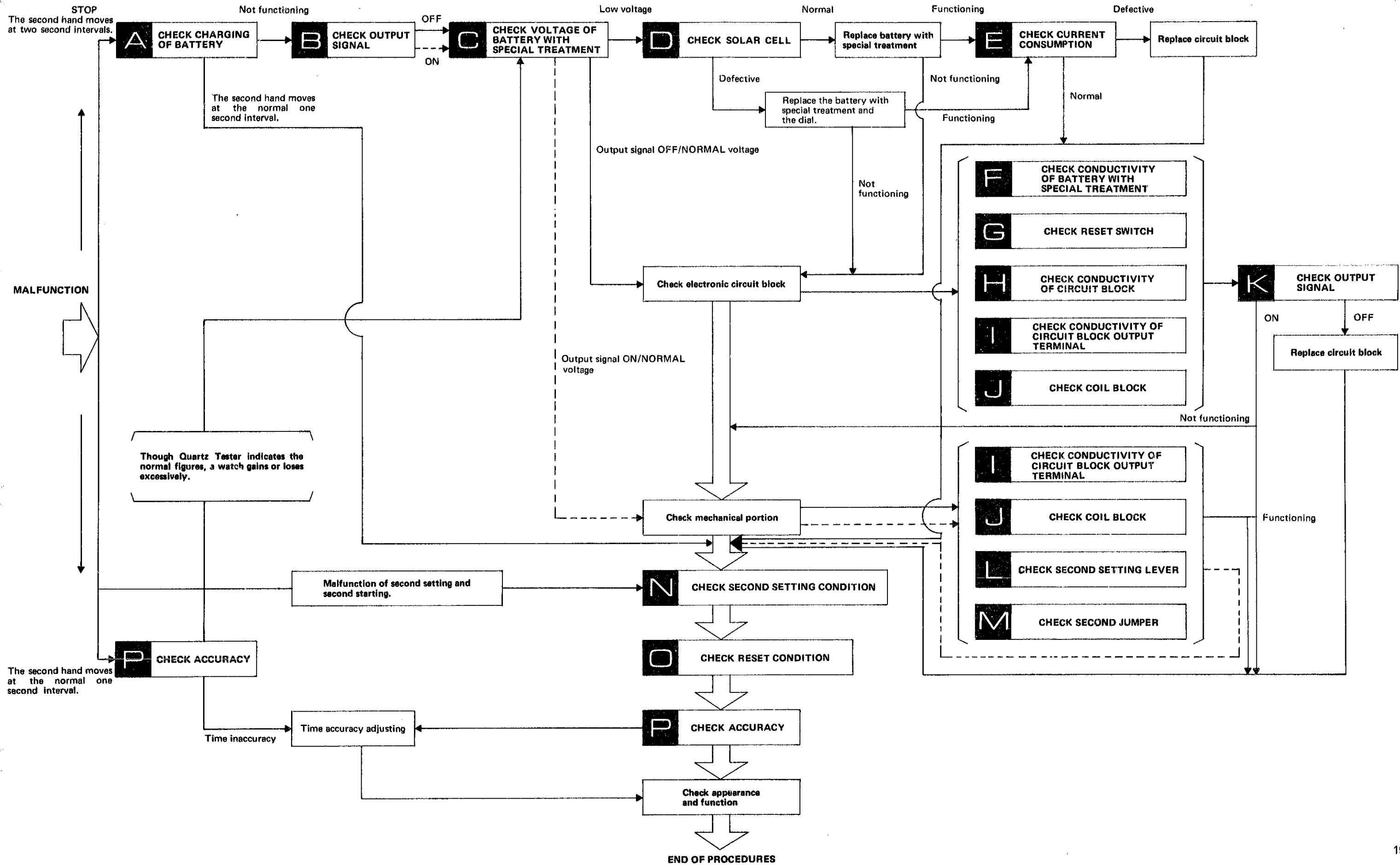



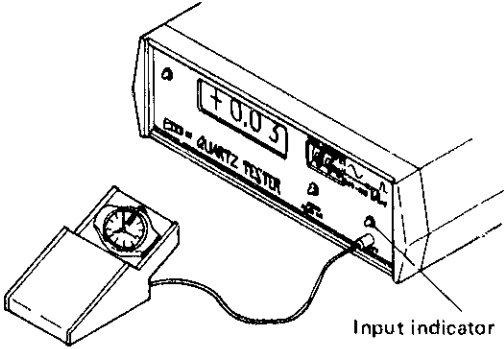
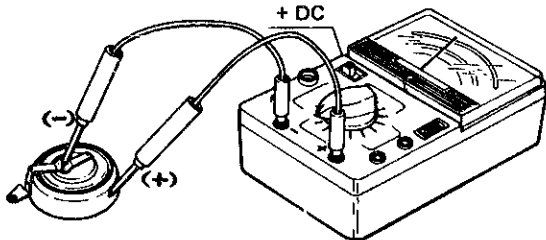
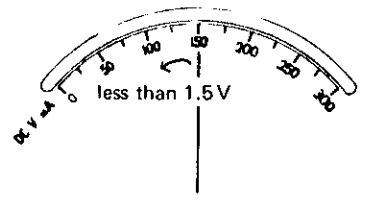

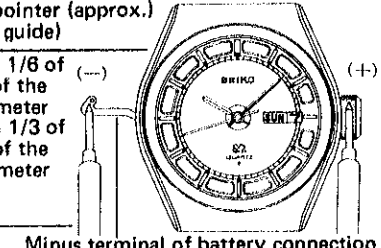
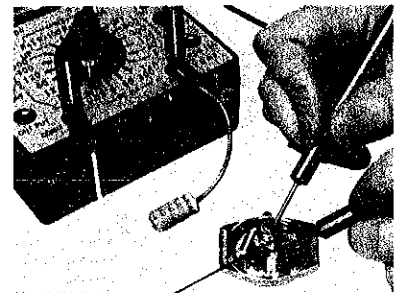
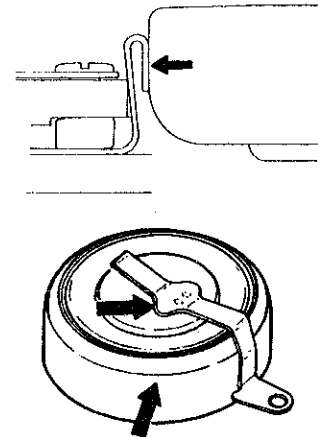

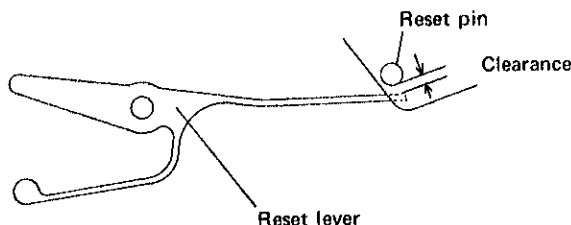
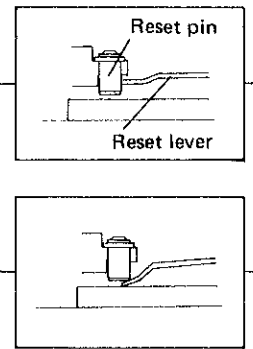
1. Guide table for checking and adjustment

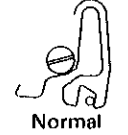
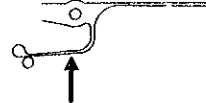
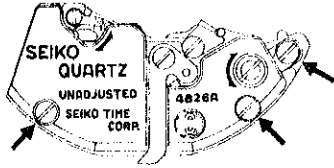
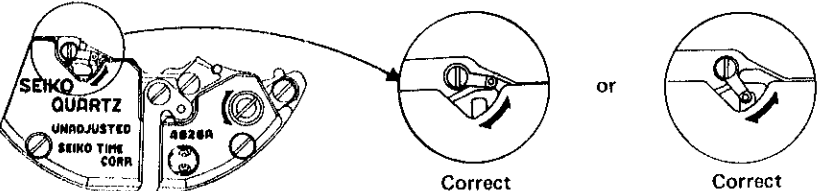



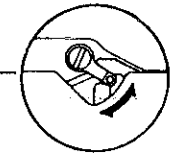

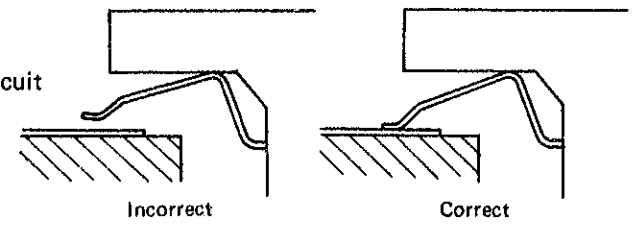
2. Procedures for Checking and Adjustment

	Procedures	Results		Adjustment and Repair								
A CHECK CHARGING OF BATTERY	<p>Check to see if the solar cell functions perfectly and the battery with special treatment is charged correctly.</p> <p>(1) With the watch either in the complete state or in the movement-with-dial state, charge the battery with special treatment by exposing the solar cell to light under the following conditions.</p> <p>The charging time required to operate the watch for 24 hours</p> <table border="1" data-bbox="261 457 931 682"> <thead> <tr> <th>Light</th> <th>Time (approx.)</th> </tr> </thead> <tbody> <tr> <td>Direct sunlight</td> <td>3 minutes</td> </tr> <tr> <td>Incandescent lamp: 100W/30 cm (12 inches) right under the light</td> <td>20 minutes</td> </tr> <tr> <td>White fluorescent lamp: 30W/15 cm (6 inches) right under the light</td> <td>90 minutes</td> </tr> </tbody> </table> <p><i>Note:</i></p> <ul style="list-style-type: none"> When charging under direct sunlight, be sure to charge the watch where there is sufficient air circulation so that it does not heat excessively. When charging under high temperature light sources such as an incandescent lamp, be careful not to place the watch too close to the light source. 	Light	Time (approx.)	Direct sunlight	3 minutes	Incandescent lamp: 100W/30 cm (12 inches) right under the light	20 minutes	White fluorescent lamp: 30W/15 cm (6 inches) right under the light	90 minutes	<p>Second hand moves _____ at the normal one second intervals.</p> <p>Not functioning _____</p>		<p>Proceed to N</p> <p>Proceed to B</p>
Light	Time (approx.)											
Direct sunlight	3 minutes											
Incandescent lamp: 100W/30 cm (12 inches) right under the light	20 minutes											
White fluorescent lamp: 30W/15 cm (6 inches) right under the light	90 minutes											
B CHECK OUTPUT SIGNAL	<p>Check for output signal.</p> <p>(1) Set Quartz Tester and connect the power supply cord to the electric outlet.</p> <p>(2) Checking Check for blinking input indication lamp.</p> <p><i>Note:</i> The checking must be made when the crown is at the normal position.</p> 	<p>One-second blinking _____</p> <p>No one-second blinking _____</p>		<p>Proceed to C</p>								
C CHECK VOLTAGE OF BATTERY WITH SPECIAL TREATMENT	<p>Use the following procedures to check the voltage of the battery with special treatment.</p> <p>(1) Set up the Volt-ohm-meter Range to be used DC 3V</p> <p>(2) Measuring</p> <ul style="list-style-type: none"> Probe Red (+): Surface (+) of the battery with special treatment Probe Black (-): Surface (-) of the battery with special treatment  <p><i>Note:</i> When handling the battery with special treatment, use a non-metallic tweezer or finger-cots.</p>	<p>More than 1.5V _____</p> <p>Less than 1.5V _____</p>		<p>In procedure B if one-second blinking is found.</p> <p>Check the Mechanical Portion</p> <p>In procedure B if one-second blinking is NOT found,</p> <p>Check the Electronic Circuit Block</p> <p>Proceed to D</p>								

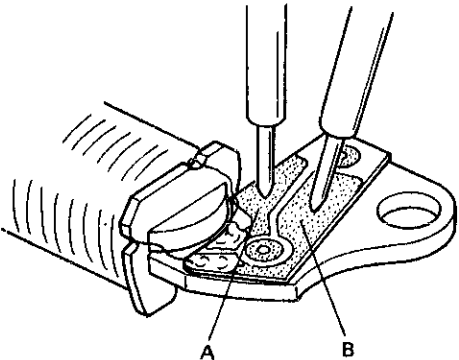
	Procedures	Results		Adjustment and Repair															
D CHECK SOLAR CELL	<p>Check to see if the solar cell functions correctly.</p> <p>(1) Remove the minus lead terminal screw, pull out the minus terminal of battery connection as shown in the illustration below, touch the black probe of the Volt-ohm-meter to the minus terminal of battery connection and touch the red probe to the case.</p> <p>(2) Then expose light to the dial and check to see if the pointer of the Volt-ohm-meter swings. (Choose one of the sources of light mentioned below when recharging the battery.) Range to be used [Example]</p> <table border="1" data-bbox="222 504 1083 724"> <thead> <tr> <th>Light</th> <th>Range</th> <th>Swing of pointer (approx.) (serve as a guide)</th> </tr> </thead> <tbody> <tr> <td>Direct sunlight</td> <td>6mA</td> <td>more than 1/6 of the scale of the volt-ohm-meter</td> </tr> <tr> <td>Incandescent lamp: 20W/30 cm (12 inches) away</td> <td>0.03mA</td> <td>more than 1/3 of the scale of the volt-ohm-meter</td> </tr> <tr> <td>40W/50 cm (20 inches) away</td> <td>-do-</td> <td>-do-</td> </tr> <tr> <td>60W/70 cm (28 inches) away</td> <td>-do-</td> <td>-do-</td> </tr> </tbody> </table> <p>(3) Cover the portion between the 5 o'clock position and the 7 o'clock position of the solar cell and expose the dial to the light by the same way in (2) and check the value the pointer indicates.</p> 	Light	Range	Swing of pointer (approx.) (serve as a guide)	Direct sunlight	6mA	more than 1/6 of the scale of the volt-ohm-meter	Incandescent lamp: 20W/30 cm (12 inches) away	0.03mA	more than 1/3 of the scale of the volt-ohm-meter	40W/50 cm (20 inches) away	-do-	-do-	60W/70 cm (28 inches) away	-do-	-do-	<p>Pointer swings.</p> <p>Pointer does not swing. <i>Note:</i> Depending upon the condition of the light, the swing of the pointer varies to some extent and it may not reach the value. If the pointer swings, however, regard it as normal.</p> <p>The pointer indicates about a half value that of measured in (2).</p> <p>The pointer indicates almost the same value or "0".</p>	<p>Normal</p> <p>Defective</p> <p>Normal</p> <p>Defective</p>	<p>Proceed to D₃</p> <p>Replace the battery with special treatment and the dial with new ones.</p> <p>Replace the battery with special treatment with new one.</p> <p>Replace the battery with special treatment and the dial with new ones.</p>
Light	Range	Swing of pointer (approx.) (serve as a guide)																	
Direct sunlight	6mA	more than 1/6 of the scale of the volt-ohm-meter																	
Incandescent lamp: 20W/30 cm (12 inches) away	0.03mA	more than 1/3 of the scale of the volt-ohm-meter																	
40W/50 cm (20 inches) away	-do-	-do-																	
60W/70 cm (28 inches) away	-do-	-do-																	
M CHECK CURRENT CONSUMPTION	<p>Check to see if the current consumption is normal by using the Micro Test or the Volt-ohm-meter. [In case of the Volt-ohm-meter]</p> <p>(1) Set up the Volt-ohm-meter</p> <ul style="list-style-type: none"> Range to be used: DC 12 μA ~ 0.03 mA Set up the condenser of 200 ~ 500 μF as shown in a photo. <p>(2) Place the watch as shown in a photo.</p> <ul style="list-style-type: none"> Place the battery with special treatment on the third wheel bridge with its minus side up. Measurement Probe Red (+): Screw hole for the battery connection of the circuit block. Probe Black (-): Surface (-) of the battery with special treatment. <p><i>Note:</i> Be careful not to touch the battery connection to the third wheel bridge.</p>  <p>Battery connection</p>	<p>Less than 4 μA</p> <p>More than 4 μA</p>	<p>Normal</p> <p>Defective</p>	<p>Proceed to N</p> <p>Replace the circuit block.</p>															
G CHECK CONDUCTIVITY OF BATTERY WITH SPECIAL TREATMENT	<p>Check to see if the voltage of the battery with special treatment is applied to the circuit block normally.</p> <p>(1) Check for any contamination on the connecting portions of the battery with special treatment and the plus terminal of the battery connection, and for any break in the welded portion of the battery connection.</p> 	<p>Uncontaminated No break</p> <p>Contaminated Break</p>	<p></p>	<p>Proceed to G</p> <p>Wipe off any foreign matter. If there is a break in the welded portion, replace the battery with special treatment with a new one.</p>															

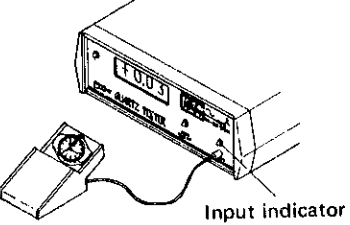
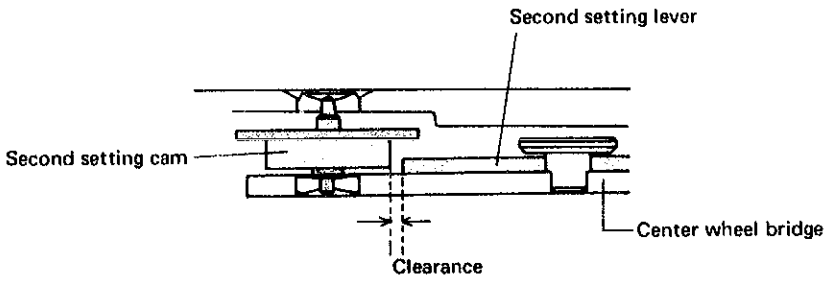
	Procedures	Results		Adjustment and Repair
CHECK RESET SWITCH	<p>Check for a short circuit of the reset lever and reset pin when the crown is at the normal position and when it is pulled out to the first click.</p> <p>Check to see if the end of the reset lever touches the reset pin when the crown is at the normal position and when it is pulled out to the first click.</p> 	<p>Clearance _____</p> <p>Touches _____</p> <p>It is under the pin _____</p>		<p>Proceed to H</p> <p>If the end of the reset lever touches the reset pin and/or if it is under the reset pin, these defects are seemed to be caused by the followings.</p> <p>(1) The driving pin for second setting lever is disengaged from the setting lever.</p>  <p>Correction to:</p>  <p>(2) Reset lever is bent</p> <p>Remove the circuit block, and adjust the shape of the reset lever.</p> 
CHECK CONDUCTIVITY OF CIRCUIT BLOCK	<p>Check for short circuit and defective contact of circuit block conducting portion.</p> <p>1. Check the three (3) screws in the diagram for looseness.</p>  <p>2. Check the position of the polarity change-over switch.</p> 	<p>No loosened screws _____</p> <p>Loosened screws _____</p> <p>Normal _____</p> <p>Switch position halfway _____</p>		<p>Proceed to H₂</p> <p>Retighten screws</p> <p>Proceed to I</p> <p>Adjust the position of the polarity change-over switch.</p> <p>Refer to "O₂ CHECK RESET CONDITION".</p>
CHECK CONDUCTIVITY OF CIRCUIT BLOCK OUTPUT TERMINAL	<p>1. Check the circuit output terminal for short circuit.</p>  <p>2. Check the rigid contact with the coil lead terminal</p>  <p>3. Remove circuit block and check for any contamination on the output terminal and coil lead terminal.</p> 	<p>Normal _____</p> <p>Short circuit _____</p> <p>Normal _____</p> <p>The output terminal is not connected with the coil lead terminal. _____</p> <p>Uncontaminated _____</p> <p>Contaminated _____</p>	 	<p>Proceed to I₂</p> <p>Correct the bend of circuit block output terminals with a tweezers.</p> <p>Proceed to I₃</p> <p>Correct the bend of circuit block output terminal with a tweezers.</p>  <p>Proceed to J</p> <p>Wipe off the contamination on terminal</p> 

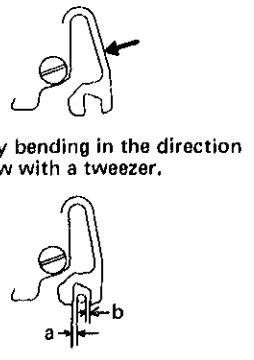
	Procedures	Results		Adjustment and Repair
<p>CHECK COIL BLOCK</p>	<p>Remove the circuit block and check for broken coil wire and short circuit of the coil block.</p> <ul style="list-style-type: none"> Set the volt-ohm-meter. Range to be used: OHMS R X 100 <p>1. Checking method</p> <p>Touch red and black probes of the tester to two terminals (A and B) of the coil respectively.</p> 	<p>2 KΩ ~ 4 KΩ</p> <p>Less than 2 KΩ (Short circuit)</p> <p>More than 4 KΩ (Broken wire)</p>		<ul style="list-style-type: none"> Proceed to K if the electronic circuit must be checked. Proceed to L if the mechanical portion must be checked. Replace the coil block Unscrew the coil block screws (2 pcs.) with the third wheel bridge. <p>Note: Hold the coil block as shown in photo.</p> 
<p>CHECK OUTPUT SIGNAL</p>	<p>Check the output signal.</p> <ul style="list-style-type: none"> Set the Quartz Tester. <p>Checking method</p> <p>Check using the same procedures as in B</p> 	<p>One-second blinking</p> <p>No one-second blinking</p>	<p>Move</p> <p>Stop</p>	<p>Proceed to N</p> <p>Check the Mechanical portion L</p> <ul style="list-style-type: none"> Replace the circuit block.
<p>CHECK SECOND SETTING LEVER</p>	<p>Check to see if the second setting lever touches the second setting cam when the crown is at the normal position and when it is pulled out to the first click.</p> <ol style="list-style-type: none"> Remove the fourth wheel and pinion and the third wheel and pinion only, and keep the second setting wheel and third wheel bridge assembled. Turn the second setting wheel slowly, and check to see if the second setting cam touches the second setting lever. 	<p>Clearance</p> <p>No clearance</p>		<p>Proceed to M</p> <p>These defects are seemed to be caused by the following:</p> <ol style="list-style-type: none"> The driving pin for second setting lever is disengaged form the setting lever.  <p>Correction to:</p>  <ol style="list-style-type: none"> Second setting lever is bent. Adjust the spring portion of the second setting lever with a tweezers. <p>After adjustment, check to see if there is clearance between "a" and "b" when the crown is pulled out to the first click as shown on the right.</p> 

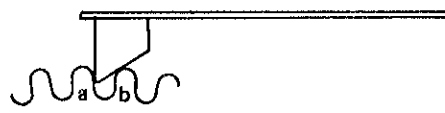
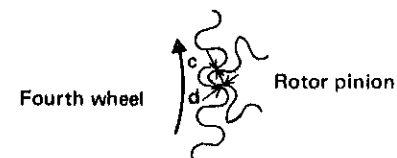
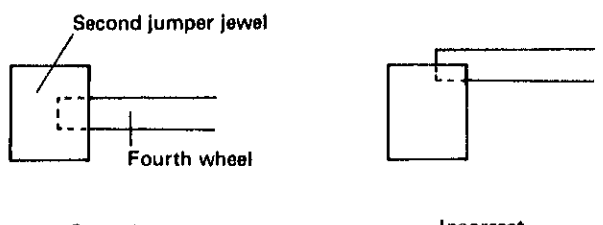
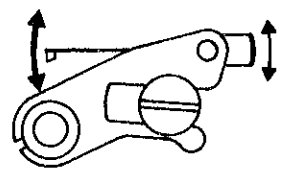
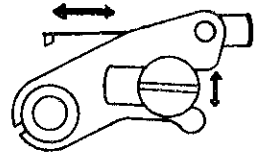
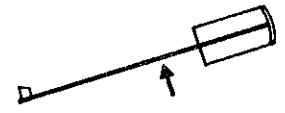
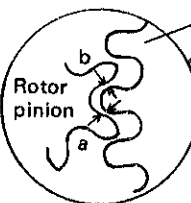
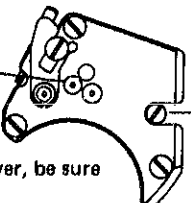
	Procedures	Results	Adjustment and Repair
<p>M</p> <p style="writing-mode: vertical-rl; transform: rotate(180deg);">CHECK SECOND JUMPER</p>	<p>Check to see the condition of the second jumper. (Check when the crown is at the normal position.)</p> <p>1. Check the position of the second jumper</p> <ul style="list-style-type: none"> • Part "A"  <p>The second jumper jewel gears with the fourth wheel at two points "a" and "b".</p> <ul style="list-style-type: none"> • Part "B" <p>Check to see if there is clearance between "c" and "d" as shown in illustration of the fourth wheel and the rotor pinion. (Check through the transparent upper hole jewel with microscope.)</p>  <p>2. Check to see if the second jumper jewel is at the proper height. Check to see if the second jumper jewel completely engages with the fourth wheel as shown in illustration.</p>  <p>Correct Incorrect</p>	<p>Correct →</p> <p>Incorrect →</p> <p>Correct →</p> <p>Incorrect →</p>	<p>Proceed to M₂</p> <ul style="list-style-type: none"> • Adjusting procedures: <ul style="list-style-type: none"> ○ Turn the second jumper. ○ Turn the eccentric post.   <p>Proceed to N</p> <p>Adjust the foot → of the pin with a tweezers.</p> 
<p>Z</p> <p style="writing-mode: vertical-rl; transform: rotate(180deg);">CHECK SECOND SETTING CONDITION</p>	<p>Check to see if the second hand stops at the ten-second positions (0, 10, 20, . . . 50 sec.) when the crown is pulled out to the 2nd click position.</p> <p>Note: Try three times or more.</p>	<p>Stops every ten-seconds → 10, 20, 30 . . . 50 second positions →</p> <p>Stops every ten-seconds, for example 5, 15, 25 . . . 55 second positions. →</p> <p>Stops irregularly →</p>	<p>Proceed to O</p> <ul style="list-style-type: none"> • The setting position of the second hand is incorrect. Correct the position. • Adjust the second setting lever using the following procedures if it is not adjusted properly. <ol style="list-style-type: none"> (1) Pull out the crown to the second click. (2) Check to see if the second setting wheel gears with the step rotor pinion by looking through the upper cap jewel (it is transparent) for step rotor with a microscope. Upper cap jewel for step rotor.  <p>The clearance is required between "a" and "b". (a > b)</p> <p>Note: After adjustment of the setting lever, be sure</p>  <p>to proceed to M CHECK SECOND JUMPER.</p>

Procedures

1. Check if the second hand starts precisely one second after the crown is pushed in to the normal position from the second click.

Note: Try three times or more.

2. Pull out the crown to the second click and check the position of the plate which shows the polarity of the step rotor and the polarity change-over switch.

Note: Check the plate which shows the polarity of the step rotor while looking through the "A" hole of the third wheel bridge.

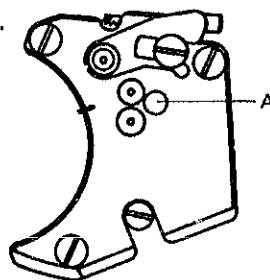

Normal position of output change-over switch

The position of the polarity change-over switch changes depending upon the position of the plate which shows the polarity of the step rotors.

Check to see if the polarity change-over switch is in the right position vis-a-vis the position of the plate which shows the polarity of the step rotors by referring to the illustrations below.

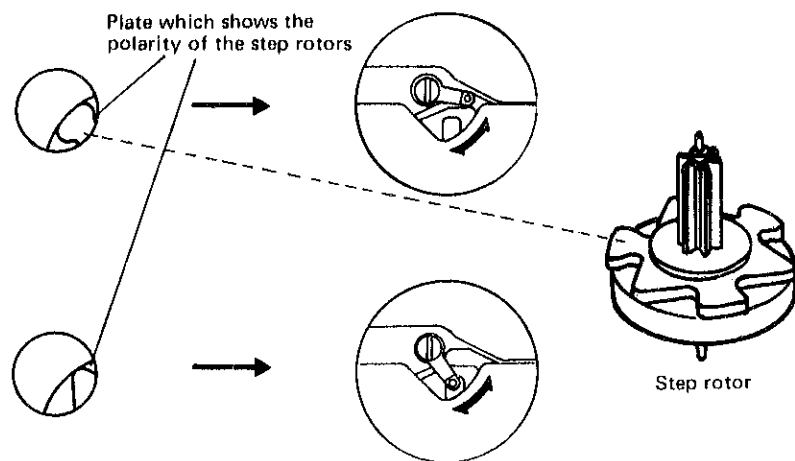

3. Pull the crown out to the 2nd click position, check the conductivity of the reset pin and the main plate.

(1) Set up the Volt-ohm-meter

Range to be used: OHMS R X 1

Note: Use the OHMS R X 1, otherwise the circuit is damaged.

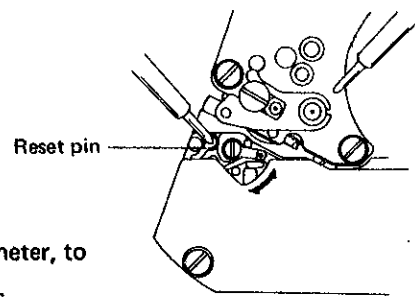

(2) Checking method

Touch the probes of the volt-ohm-meter, to the third wheel bridge and reset pin.

Results

Starts moving after one second

Starts moving immediately or moves irregularly

Less than 10 Ω

More than 10 Ω

Adjustment and Repair

Proceed to



Proceed to



- Replace the circuit block.

- The reset lever does not touch the reset pin properly.

- These defective conditions seem to be caused by the following. Remove the third wheel bridge, third wheel and pinion, fourth wheel and pinion and second setting wheel, and repair.

(1) The driving pin for second setting lever of the setting lever is not touching the second setting lever.



Incorrect

Correction to:



Correct

(2) The reset lever is not touching the second setting lever.



Incorrect

Correction to:



Correct

Note: Bend the reset lever in order to prevent disengagement.

(3) The reset lever is bent.

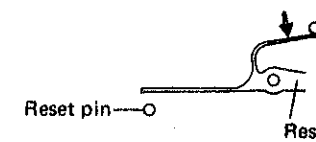

Incorrect

Correction to:

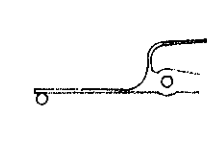

Correct

Correct the bend of the reset lever (the arrow-marked portion) with tweezers.

D

Check gain and loss of time.

**CHECK
ACCURACY**

Follow the same procedures as in step

B

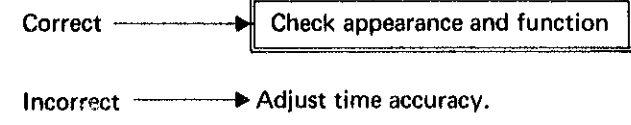

All procedures of Disassembling, Reassembling, Checking and Adjustment are completed.