

PARTS CATALOGUE/TECHNICAL GUIDE

Cal. 4M21A

[SPECIFICATIONS]

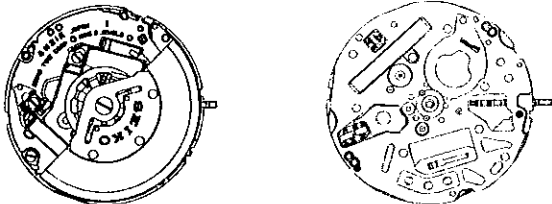



Item		Cal. No.	4M21A
Movement			
			(x 1.0)
Movement size	Outside diameter		ø26.4 mm
	Casing diameter		ø25.6 mm
	Height		2.7 mm
Time indication			3 hands
Driving system			Step motor (Load compensated driving pulse type)
Additional mechanism			<ul style="list-style-type: none"> • Automatic generating system • Power reserve indicator • Overcharge prevention function • Energy depletion forewarning function • Electronic circuit reset switch • Train wheel setting device
Loss/gain			Monthly rate at normal temperature range: less than 15 seconds
Regulation system			Nil
Measuring gate by quartz tester			Use 10-second gate.
Power supply	Power generator		Automatic generating system
	Capacitor		Polyacene lithium condenser
Operating voltage range			0.5 ~ 2.3 V
Duration of charge			From full charge to stoppage: Approx. 72 hours (3 days)
Jewels			9 jewels

PARTS CATALOGUE

Cal. 4M21A

Disassembling procedures Figs. : (1) → (46)

Reassembling procedures Figs. : (46) → (1)

Lubricating: Types of oil		Oil quantity
	Moebius A	 Normal quantity
	SEIKO Watch Oil S-6	 Liberal quantity

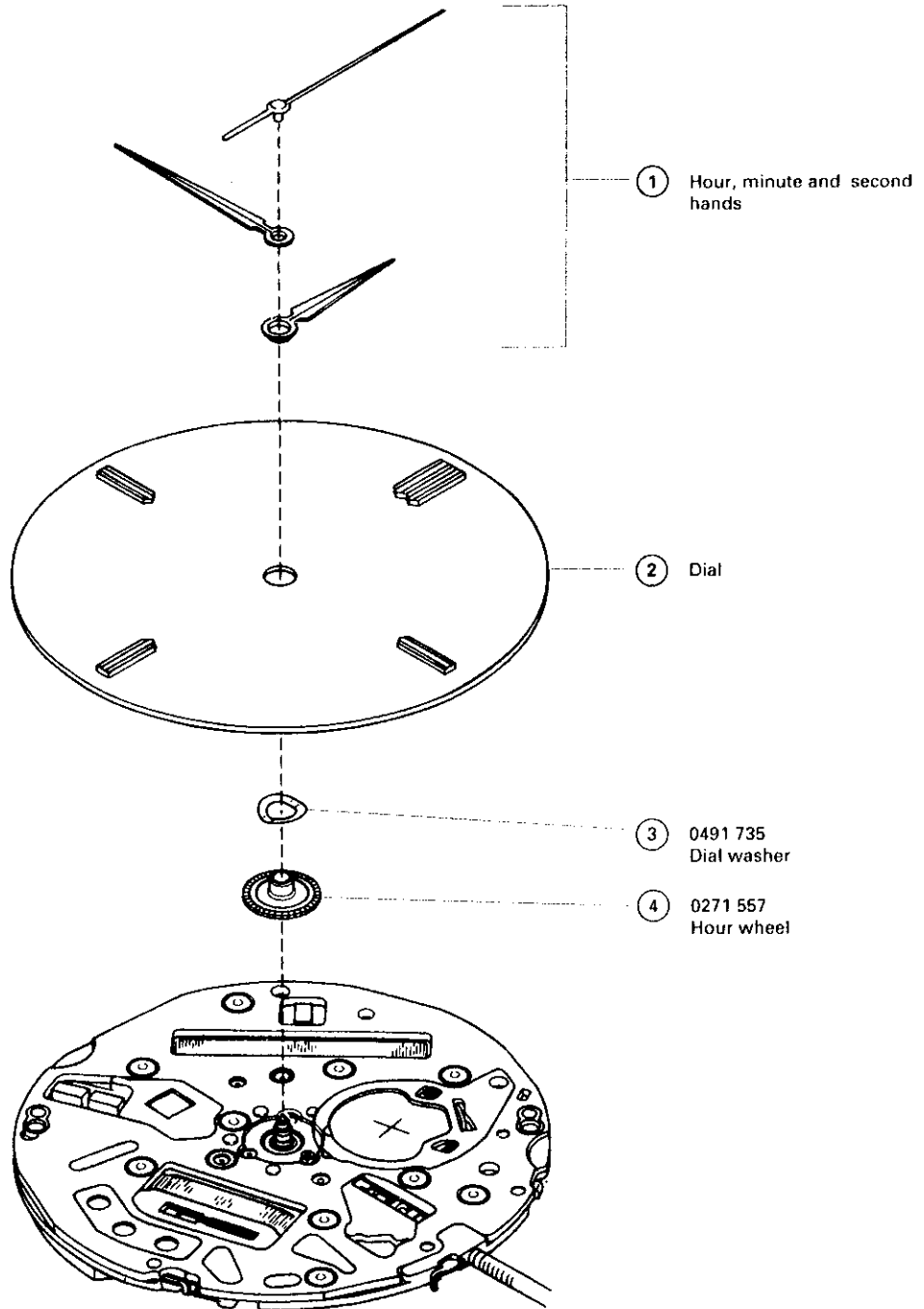

 Please see the remarks on the following pages.
(Lubricating of some parts is shown in "II. REMARKS ON DISASSEMBLING AND REASSEMBLING")

PARTS CATALOGUE

Cal. 4M21A

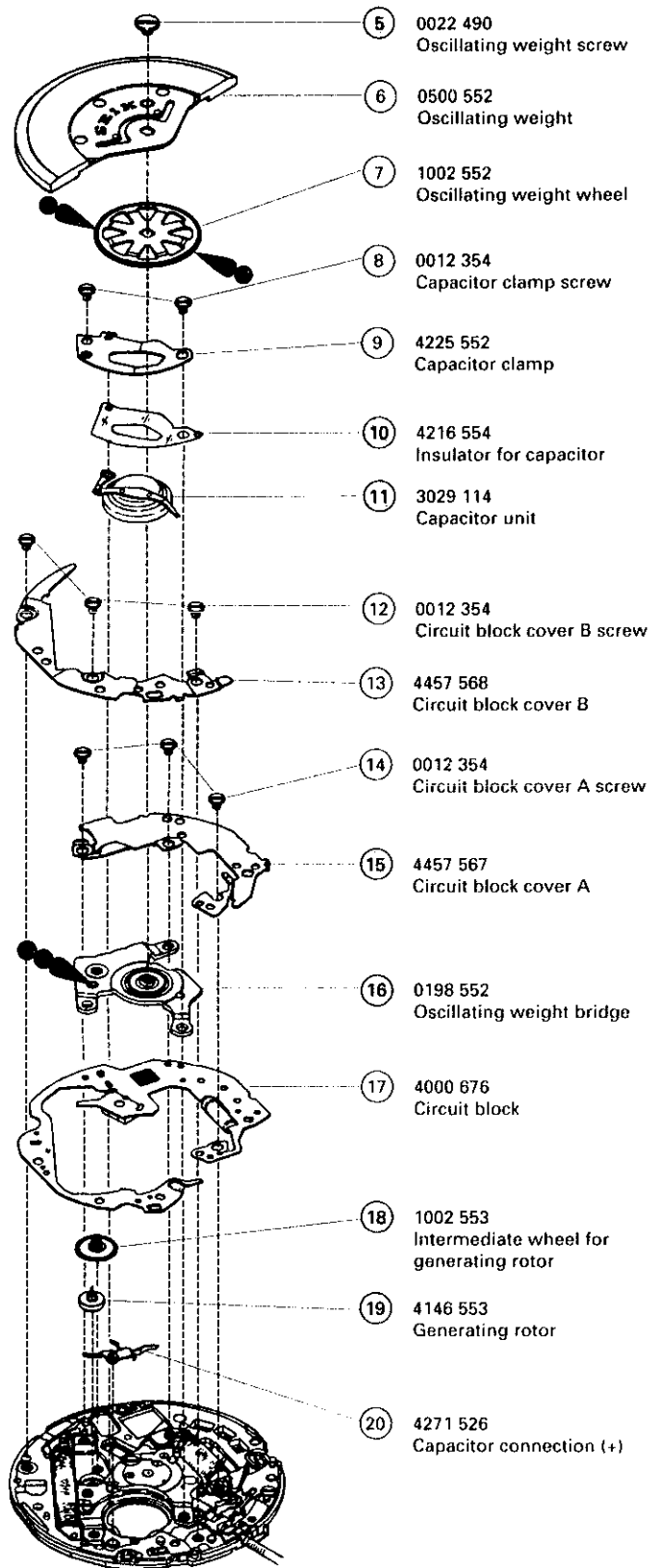

	0012 354	
	• Capacitor clamp screw	(2 pcs.)
	• Circuit block cover B screw	(3 pcs.)
	• Circuit block cover A screw	(3 pcs.)
	• Train wheel bridge screw	(1 pc.)
	• Setting lever spring screw	(1 pc.)
	0022 490	
	• Oscillating weight screw	(1 pc.)

○ ⇨ Please see the remarks on the following pages.
(Lubricating of some parts is shown in "II. REMARKS ON DISASSEMBLING AND REASSEMBLING")

PARTS CATALOGUE

Cal. 4M21A

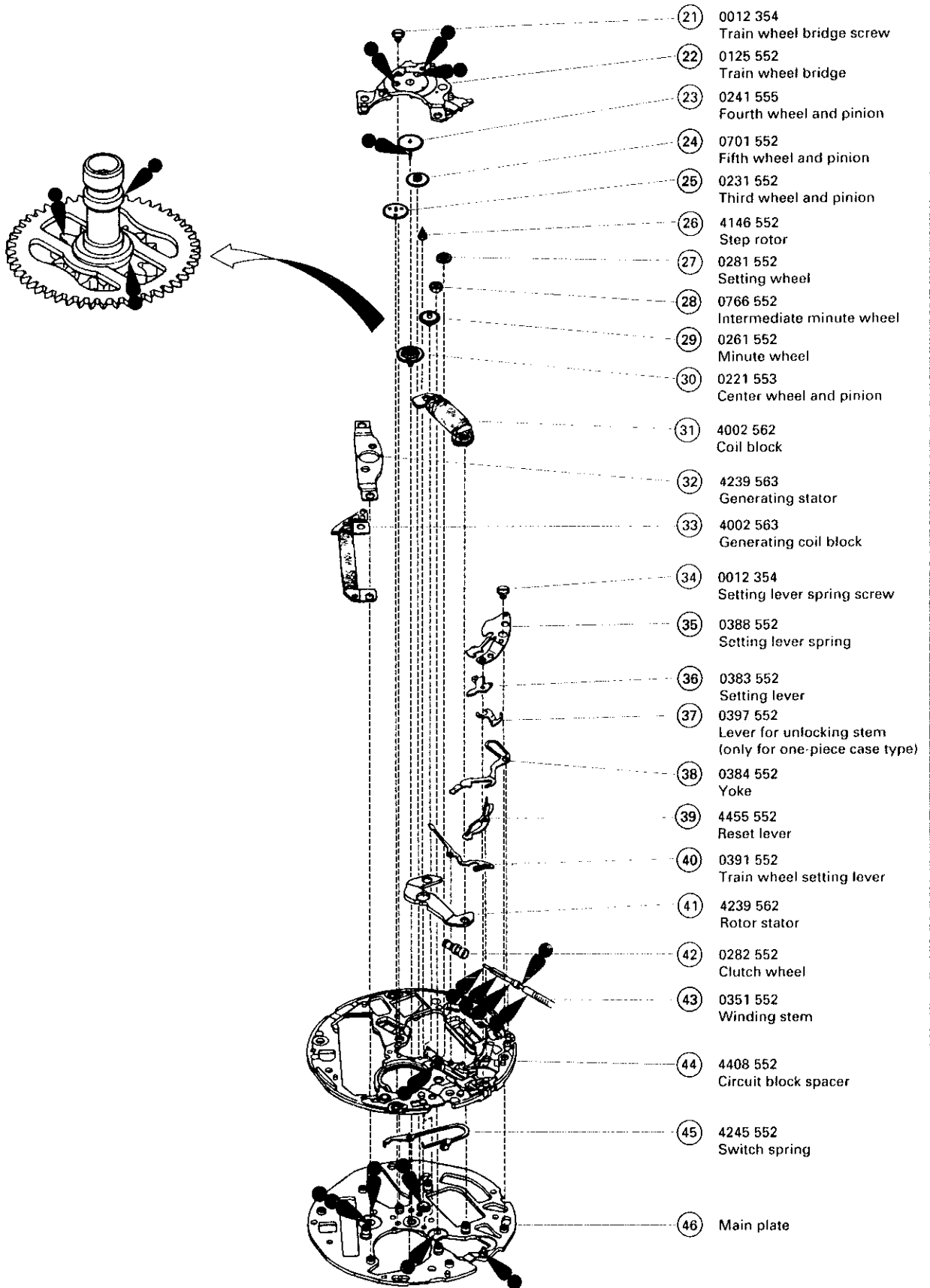

○ ⇨ Please see the remarks on the following pages.
(Lubricating of some parts is shown in "II. REMARKS ON DISASSEMBLING AND REASSEMBLING")

PARTS CATALOGUE

Cal. 4M21A

Remarks:

• **List of jewels**

Part No.	Name
0011 432	<ul style="list-style-type: none"> • Lower hole jewel for generating rotor • Upper hole jewel for generating rotor • Lower hole jewel for intermediate wheel for generating rotor

Part No.	Name
0011 526	<ul style="list-style-type: none"> • Lower hole jewel for third wheel and pinion • Lower hole jewel for fifth wheel and pinion
0011 591	Lower hole jewel for step rotor

• **List of tubes**

Part No.	Name
0023 340	Tube for switch spring axle
0036 045	Tube for train wheel bridge
0036 046	<ul style="list-style-type: none"> • Tube for capacitor clamp screw (B) • Tube for circuit block cover A screw (B)

Part No.	Name
0036 047	<ul style="list-style-type: none"> • Tube for circuit block cover A screw (C) • Tube for setting lever spring screw • Tube for circuit block cover B screw
0036 048	<ul style="list-style-type: none"> • Tube for capacitor clamp screw (A) • Tube for circuit block cover A screw (A)

• **Other parts**

Part No.	Name
0023 340	Switch spring axle
0390 552	Setting lever axle

Part No.	Name
0428 552	Center pipe

④3 Winding stem 0351 552

The type of winding stem is determined based on the design of cases. Check the case number and refer to "SEIKO Casing Parts Catalogue" to choose a corresponding winding stem.

- The explanation here is only for the particular points of Cal. 4M21A.
- For the repairing, checking and measuring procedures, refer to the "TECHNICAL GUIDE, GENERAL INSTRUCTIONS".

I. STRUCTURE OF THE CIRCUIT BLOCK

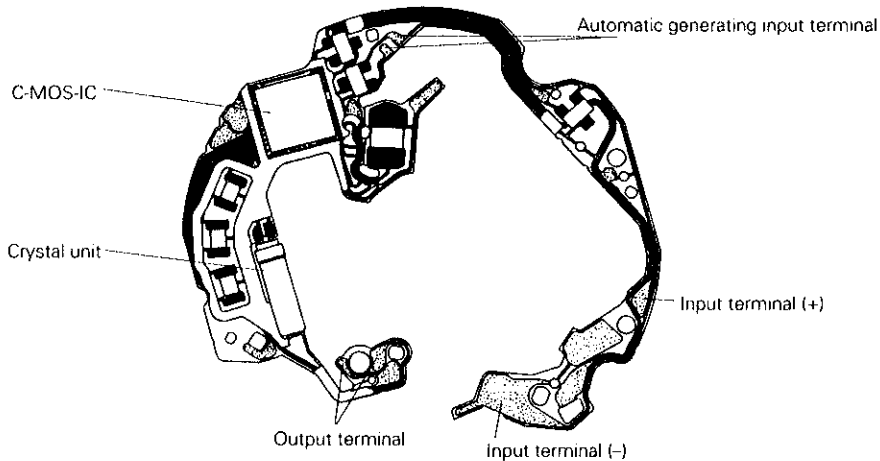

II. REMARKS ON DISASSEMBLING AND REASSEMBLING

- * For disassembling and reassembling, do not use such type of universal movement holder that clamps the movement only at its circumference. Instead, place the movement directly on a riveting plate or other hard plate in the manner that the largest possible portion of the movement is supported by the plate.

① Hands

• How to install

Place the movement directly on the riveting plate shown in the illustration with the oscillating weight side down, so that the oscillating weight screw is not damaged. Then, press in the hands.

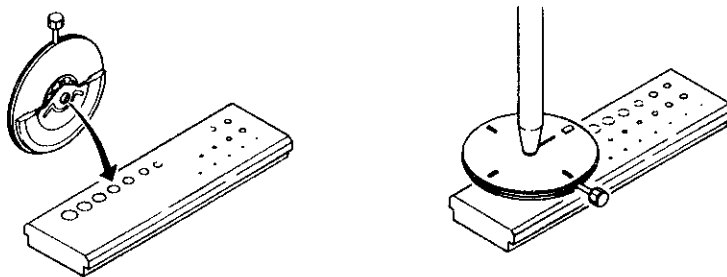

② Dial

• How to install

- Place the movement on the riveting plate with the back side down, and push in the dial.
- After setting the dial, check that it is fixed securely in position.

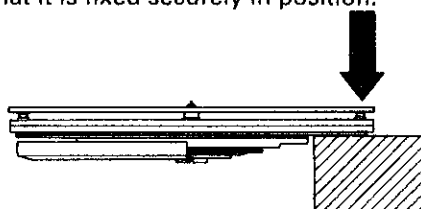

5 Oscillating weight screw

Tighten the oscillating weight screw very firmly, applying more force than usual.

Note: When tightening the oscillating screw, be careful not to press down on the movement hard with the screwdriver.

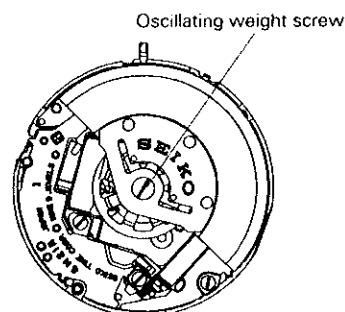

10 Insulator for capacitor

• How to install

Slip the insulator for capacitor into the gap under the oscillating weight bridge to set it to the guide post.

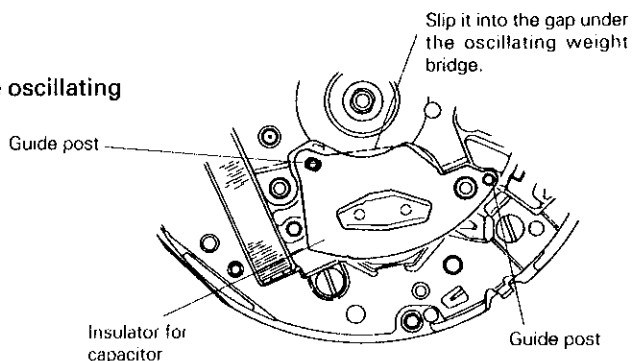

11 Capacitor unit

• How to install

- 1) Set the track hole of the capacitor connection (-) to the guide post of the circuit block spacer.
- 2) Slide the capacitor in the direction of the arrow until it is set under the oscillating weight bridge.
- 3) Push the "A" portion to fix the capacitor unit in position.

Note: Handle the capacitor unit with care so as not to short-circuit its (+) and (-) terminals.

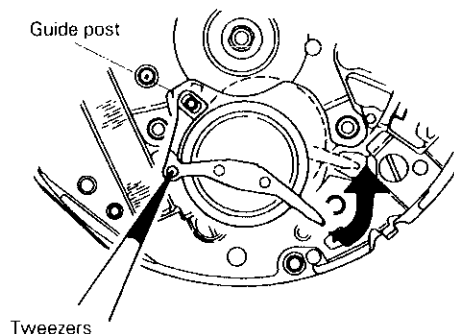

Slip it into the gap under the oscillating weight bridge.

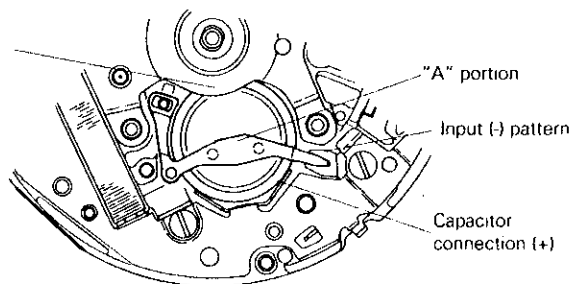

15 Circuit block cover A

• How to remove

- 1) Remove the three circuit block cover A screws.
- 2) Lift the "A" portion in the illustration at right using tweezers, and then move the circuit block cover A in the direction of the arrow to release the hooking portion.

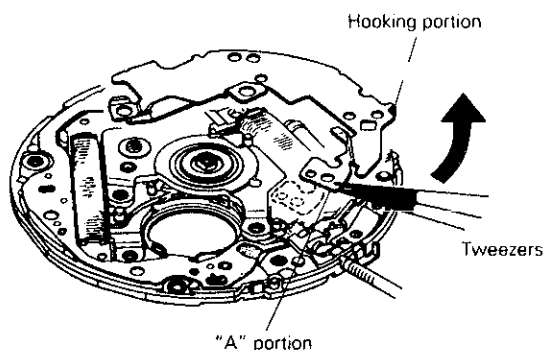

• **How to install**

- 1) Set all the guide holes in position except the hooking portion, and then tighten the three screws.
* Before tightening the screws, check that the pivots of the generating rotor and intermediate wheel for generating rotor are inserted properly.
- 2) Push the upper part of the hooking portion indicated by the arrow in the illustration at right, to have the hooking portion catch the main plate.
- 3) Check that the hooking portion securely catches the main plate.

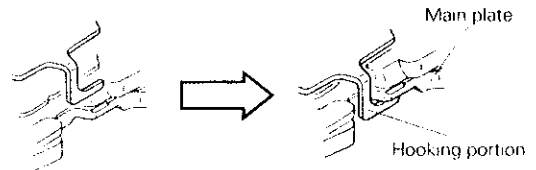
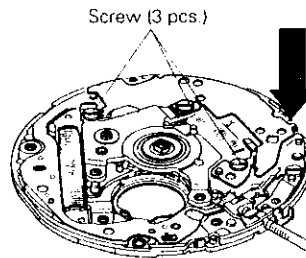

①⑥ Oscillating weight bridge

• **Lubricating**

Be sure to lubricate the ball-bearing of the oscillating weight bridge at the two locations indicated in the illustration at right.

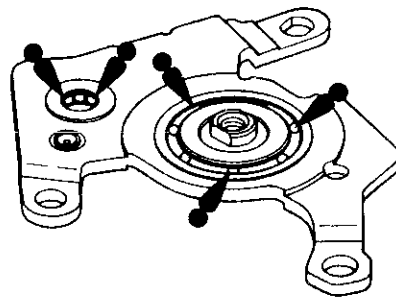

①⑧ Intermediate wheel for generating rotor

①⑨ Generating rotor

• **Lubricating**

Be sure to lubricate the intermediate wheel for generating rotor and the generating rotor in the quantity specified in the illustrations below.

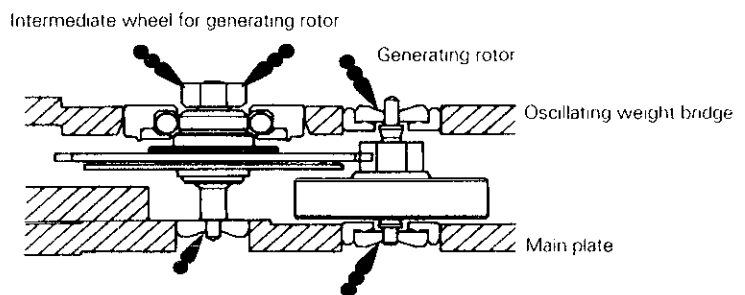
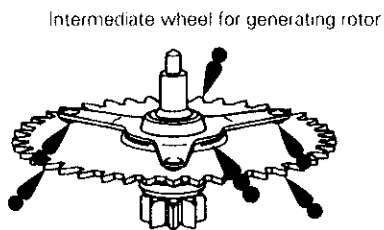

②② Train wheel bridge

• **Setting position**

Refer to the illustrations below to check where to install the respective wheels.

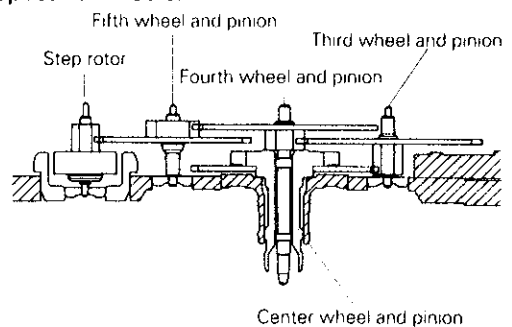
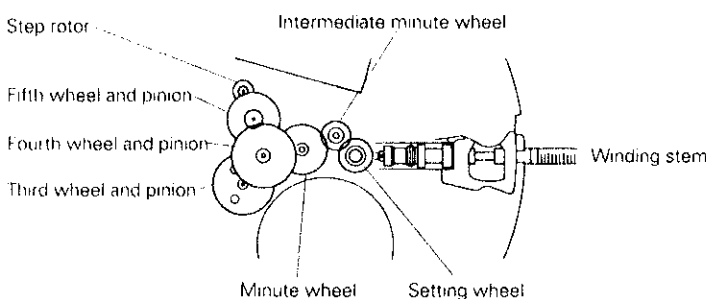

- ②4 Fifth wheel and pinion
- ②5 Third wheel and pinion
- ②9 Minute wheel

• **Lubricating**

Before setting the fifth wheel and pinion, third wheel and pinion, and minute wheel, lubricate their lower pivots as shown in the illustrations below.

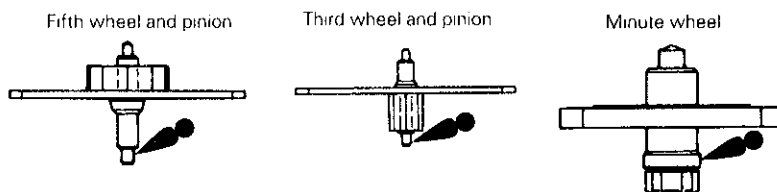

- ②8 Intermediate minute wheel

• **How to install**

Set the intermediate minute wheel in the direction as shown in the illustration at right, taking care not to set it upside down.

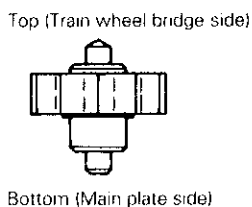

- ③5 Setting lever spring

- Install the setting lever spring so that the post of the setting lever is set at the position indicated in the illustration at right.
- After tightening the setting lever spring screw, have the spring catch the post of the setting lever.
- For lubrication, refer to the illustration at right.

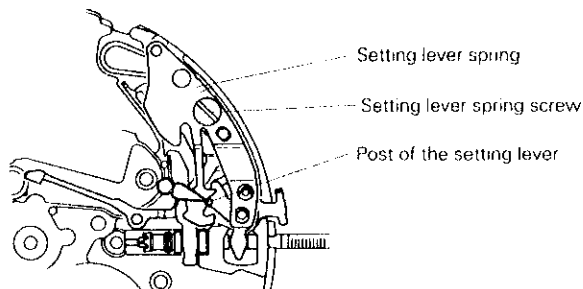

- ③6 Setting lever

- ③7 Lever for unlocking stem

- ③8 Yoke

- ③9 Reset lever

- ④0 Train wheel setting lever

• **Setting position and lubricating of the parts for setting mechanism**

Refer to the illustration at right.

Note: Be sure to set the springs of the yoke and reset lever in the correct direction, taking care not to deform the springs.

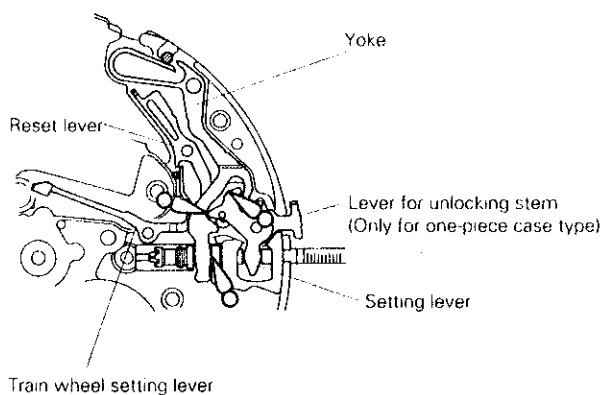

Note: Insert the post on the rear of the setting lever ("A" portion in the illustration below) properly into the long slot of the train wheel setting lever ("B" portion in the illustration below).

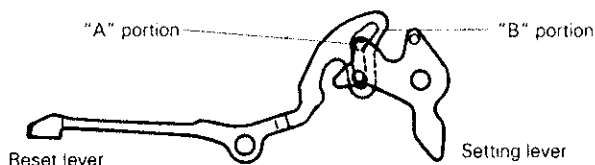

III. VALUE CHECKING AND ADJUSTMENT

- **Coil block resistance**

2.2 K Ω ~ 2.7 K Ω

- **Generating coil block resistance**

300 Ω ~ 380 Ω

- **Current consumption**

For the whole movement : Less than 0.6 μ A (with voltage supplied from a battery)

For the circuit block alone : Less than 0.2 μ A (with voltage supplied from a battery)

- **Measuring the current consumption for the whole movement**

1) Connect the tester as shown in the illustration.

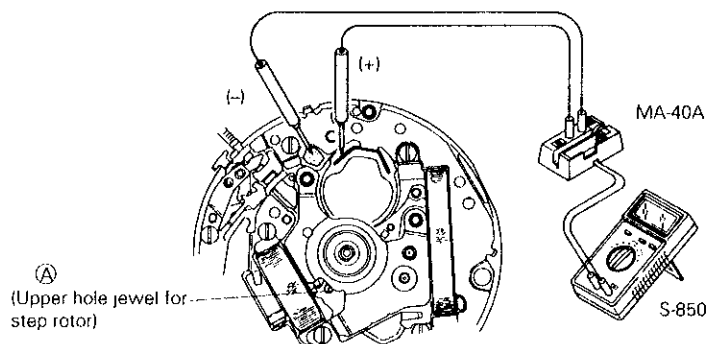

2) Start the measurement 30 to 40 seconds after connecting the tester, checking that a stable measurement is obtained.

3) When measuring, look through the upper hole jewel for step rotor (A in the illustration), to check that the step rotor is rotating at one-second intervals.

- **Measuring the current consumption for the circuit block alone**

1) Connect the tester to the input terminals (+) and (-) of the circuit block.

2) Start the measurement 30 to 40 seconds after connecting the tester, checking that a stable measurement is obtained.

Remarks:

When the current consumption exceeds the standard value for the whole movement but is within the standard value range for the circuit block alone, the watch is generating a driving pulse to compensate for the heavy load that may be applied to the gear train, etc.

In this case, overhaul and clean the movement parts and then measure current consumption for the whole movement again.

- **Checking the automatic generating system**

1) Apply the probes of the tester to the capacitor unit as shown in the illustration to measure the voltage.

Note: Take care not to short-circuit the capacitor unit. If it has been short-circuited, leave the watch untouched for more than 10 minutes, and then measure the voltage again.

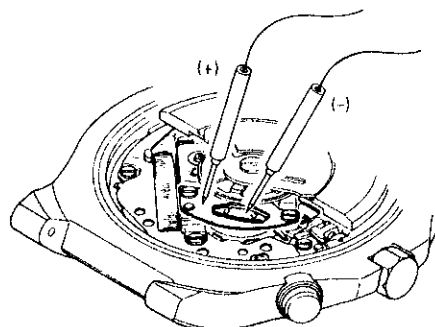

- 2) Close the case back, and swing the watch from side to side approximately 100 times rhythmically (at a rate of 2 to 3 times a second) with a snap of the wrist as shown in the illustration.

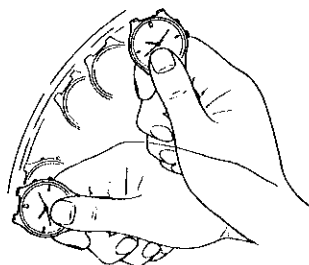

- 3) Leave the watch untouched for more than 5 minutes, and then measure the voltage of the capacitor unit in the same manner as in step 1) above.
- 4) If the voltage obtained has increased 0.2 V to 0.3 V from the initial voltage assuming that the initial voltage is within the range between 0.5 V and 1.0 V, the automatic generating system is operating normally.

* To recheck the automatic generating system, leave the watch untouched for more than 5 minutes, and then repeat steps 1) to 3) above.

Recharging information:

- Number of swings required and the duration of charge until the watch stops operating

Cal. 4M Series watches are equipped with a power reserve indicator. The current power reserve can be checked using the second hand at the press of a button.

(The table below assumes that the initial voltage of the capacitor unit is 0.5 V.)

Number of swings	Duration of charge	Quick movement of the second hand when the power reserve indicator function is activated
100	Approx. 3 hours	5 seconds
500	Approx. 1 day	10 seconds
800	Approx. 2 days	20 seconds
1,200	Approx. 3 days	30 seconds

Note: If the voltage of the capacitor unit fluctuates, the movement of the second hand may not indicate the actual power reserve. To check the relationship between the number of swings and the duration of charge, use the power reserve indicator more than one hour after swinging the watch the number of times specified in the above table, and then check if the watch keeps operating for the indicated duration of charge.

SUPPLEMENT TO PARTS CATALOGUE/TECHNICAL GUIDE Cal. 4M21A VOL. 2

CHANGE OF POWER RESOURCE AND PARTS INFORMATION FOR Cal. 4M21A

While we have once issued "SUPPLEMENT TO PARTS CATALOGUE/TECHNICAL GUIDE Cal. 4M21A", we would like to inform you here that the following movement parts for Cal. 4M21A are changed again to new ones which lead to enhanced performance and longer duration.

Notes:

- When repairing Cal. 4M21A watches, please be sure to refer to this supplement together with "PARTS CATALOGUE/TECHNICAL GUIDE Cal. 4M21A" issued in Aug. 1996 and "SUPPLEMENT TO PARTS CATALOGUE/TECHNICAL GUIDE Cal. 4M21A" issued in Nov. 1999.
- When the new rechargeable battery unit is installed into the movement, please note that the original capacitor clamp should not be used. If the original clamp is used with new rechargeable battery unit, it could lead to short circuit or damage the movement. To avoid disorder, please order new rechargeable battery unit and rechargeable battery clamp in a set by parts code "3027 4MZ" (3027 4MZ contains both rechargeable battery unit and rechargeable battery clamp.)
- After the new rechargeable battery unit is installed, the indicator display for duration of charge will change. Please see below chart of "Comparative matrix between original and new power resource".
- Regarding the circuit block, there will be no change. Please refer to "SUPPLEMENT TO PARTS CATALOG/TECHNICAL GUIDE Cal.4M21A" issued in Nov.1999.
- In and after June 2000, original capacitor unit will be discontinued and no longer available. New parts in a set (rechargeable battery unit and rechargeable battery clamp) will be supplied to you if you order the old capacitor by parts No. 3029 114 or 3029 116.

[INFORMATION: Comparative matrix between original and new power resource]

Indicator display and Duration (Approx.)		Original capacitor / 1st upgraded capacitor (3029 114 / 3029 116)	New rechargeable battery unit (3027 29R)
	5 seconds	3 hours	3 hours
	10 seconds	1 day	1 ~ 20 days
	20 seconds	2 days	20 ~ 40 days
	30 seconds	3 days	40 ~ 42 days
Indicator display and Number of swings (Approx.)*	5 seconds	100 times	100 times
	10 seconds	350 ~ 400 times	350 ~ 400 times
	20 seconds	700 ~ 800 times	6000 times
	30 seconds	1050 ~ 1200 times	12000 times

* The number of swings may differ according to the way of swinging.

PARTS LIST

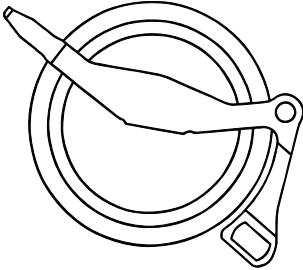
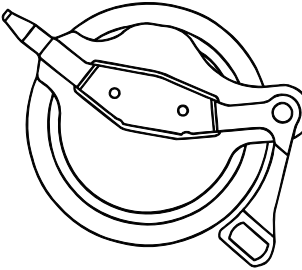
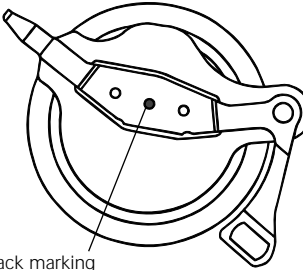
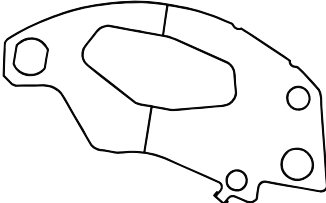
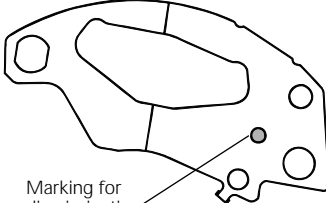
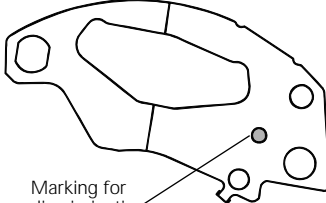
Part name	Original parts	1st upgraded parts (Introduced in the Supplement issued in Nov. 1999)	New parts
K.E.S.U. (Capacitor unit / Rechargeable battery unit)	<p>3029 114 (Capacitor unit)</p> 	<p>3029 116 (Capacitor unit)</p>  <p>"ES614" is written on the other side.</p>	<p>*3027 29R (Rechargeable battery unit)</p>  <p>Black marking</p> <p>"MT616" is written on the other side.</p>
Capacitor clamp / Rechargeable battery clamp	<p>4225 552</p> 	<p>4225 552 (Code unchanged) This can be used with original capacitor unit also.</p>  <p>Marking for discrimination</p>	<p>*4225 552 (Same as 1st upgraded one)</p>  <p>Marking for discrimination</p>

* When you change the original power resource to new rechargeable battery unit, the clamp is also required to be changed. Please order them as a set by parts code 3027 4MZ to avoid confusion. (3027 4MZ contains both rechargeable battery unit and rechargeable battery clamp)

* Each parts also can be supplied separately by each parts code.