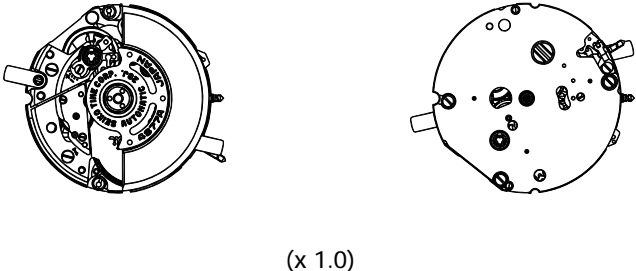

PARTS CATALOGUE / TECHNICAL GUIDE

Cal. 4S77A

[SPECIFICATIONS]

Brand		CREDOR
Cal. No.		4S77A
Item		
Movement		 <p>(x 1.0)</p>
Movement size	Outside diameter	ø26.0 mm
	Casing diameter	ø25.6 mm
	Height	5.38 mm
Time indication		Three hands (Hour, minute and second hands) with 24-hour, date and day hands
Vibrations per hour		28,800 (8 beats per second)
Additional mechanism		<ul style="list-style-type: none"> • Automatic winding (with auxiliary hand winding mechanism) • Calendar indicated by hands (Date and day of the week) • Instant setting device for date and day calendar • 24-hour hand • Independent adjustment of hour hand • Micro-regulating device • Second setting device • Regulating device by micro-positioning regulator pin
Loss/gain		Daily rate at normal temperature range: Within a range between +15 seconds and -10 seconds
Jewels		28 jewels

SEIKO CORPORATION





PARTS CATALOGUE

Cal. 4S77A



Disassembling procedures Figs. : (1) ~ (80)

Reassembling procedures Figs. : (80) ~ (1)

Lubricating:

- Types of oil**
-  Moebius V
 -  Moebius A
 -  SEIKO Watch Oil S-6
 -  SEIKO Watch Oil S-4
 -  SEIKO Watch Oil S-3

Oil quantity

-  Liberal quantity
-  Normal quantity
-  Extremely small

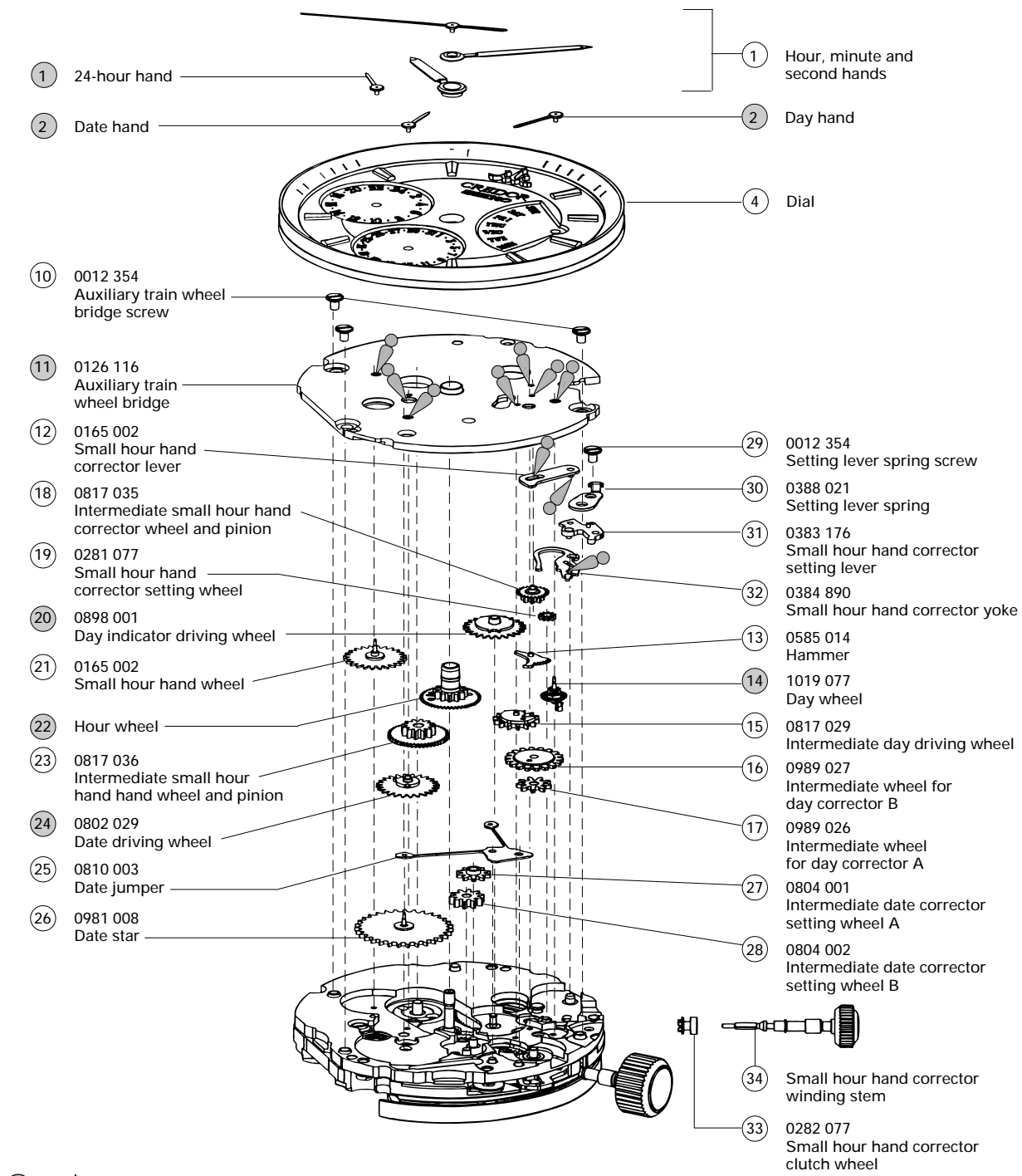

 Please see the remarks on the following pages.

PARTS CATALOGUE

Cal. 4S77A

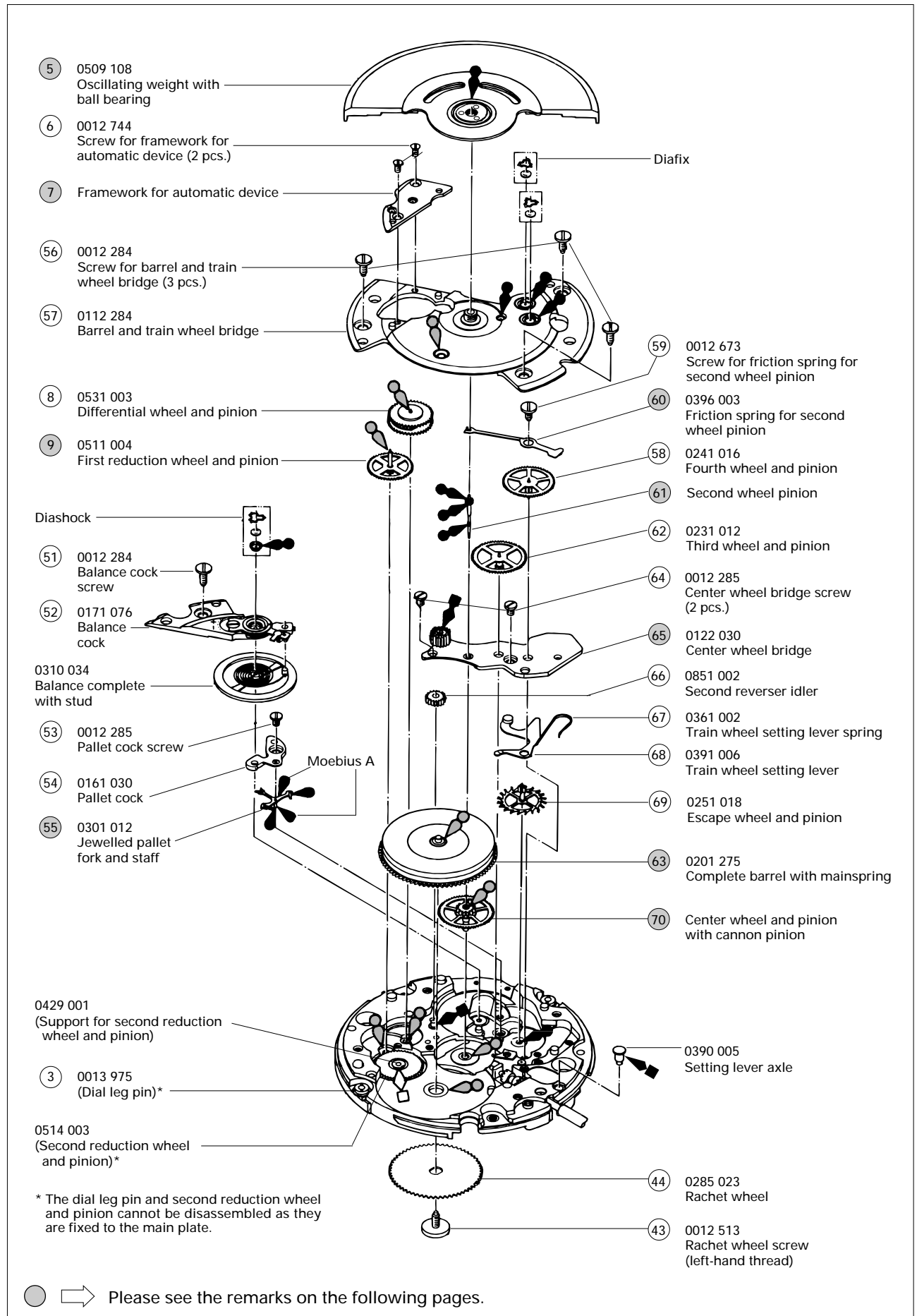

➡ Please see the remarks on the following pages.

PARTS CATALOGUE

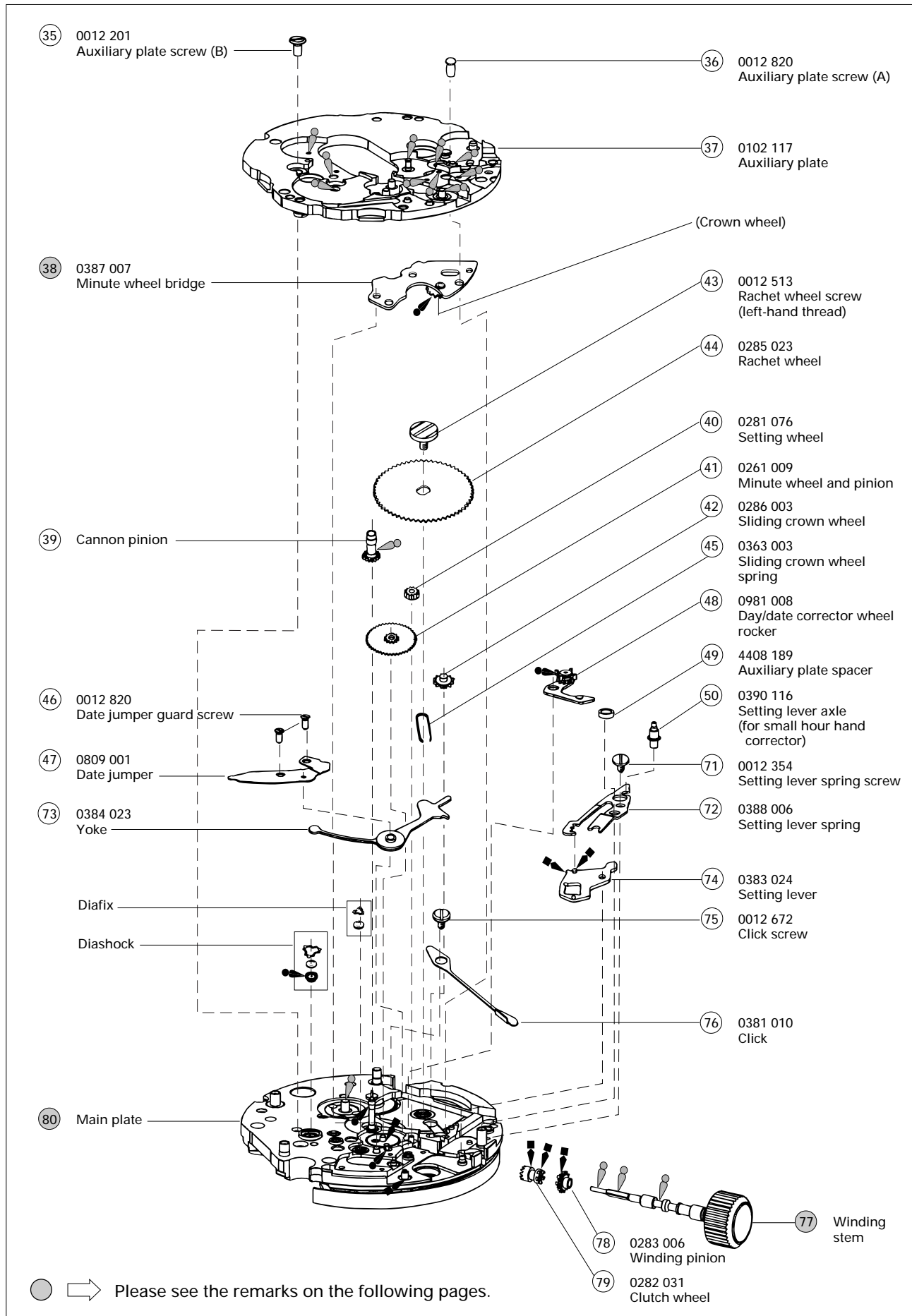

Cal. 4S77A



PARTS CATALOGUE

Cal. 4S77A

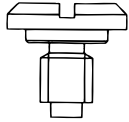
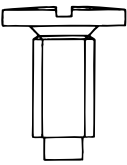
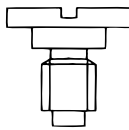
• List of screws

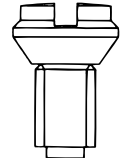
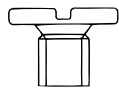
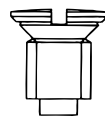
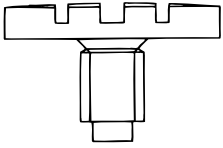
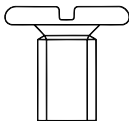
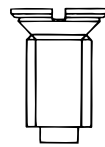
Part No.	Name	Part No.	Name
 0012 121	<ul style="list-style-type: none"> • Stud screw 	 0012 672	<ul style="list-style-type: none"> • Click screw
 0012 284	<ul style="list-style-type: none"> • Screw for barrel and train wheel bridge • Balance cock screw 	 0012 673	<ul style="list-style-type: none"> • Screw for friction spring for second wheel pinion
 0012 285	<ul style="list-style-type: none"> • Center wheel bridge screw • Pallet cock screw 	 0012 726	<ul style="list-style-type: none"> • Casing clamp screw
 0012 354	<ul style="list-style-type: none"> • Yoke holder screw • Auxiliary train wheel bridge screw • Setting lever spring screw 	 0012 744	<ul style="list-style-type: none"> • Screw for framework for automatic device
 0012 513	<ul style="list-style-type: none"> • Ratchet wheel screw 	 0012 201	<ul style="list-style-type: none"> • Auxiliary plate screw (B)
		 0012 820	<ul style="list-style-type: none"> • Auxiliary plate screw (A) • Date jumper guard screw

PARTS CATALOGUE

Cal. 4S77A

• List of jewels

Part No.	Name	Part No.	Name
0011 221	<ul style="list-style-type: none"> • Diashock upper/lower cap jewel • Diafix upper cap jewel for fourth wheel and pinion • Diafix upper/lower cap jewel for escape wheel and pinion 	0011 540	• Upper/lower hole jewel for third wheel and pinion
		0011 541	• Lower hole jewel for fourth wheel and pinion
		0011 505	• Upper/lower hole jewel for jewelled pallet fork and staff
0011 398	• Upper hole jewel for complete barrel with mainspring	0011 151	• Upper/lower hole jewel for first reduction wheel and pinion
0011 715	• Upper hole jewel for center wheel and pinion	0011 422	• Upper hole jewel for differential wheel and pinion
0011 146	• Lower hole jewel for center wheel and pinion	0011 157	• Lower hole jewel for differential wheel and pinion

• List of tubes and pins

Part No.	Name	Part No.	Name
0013 934	• Micro adjuster pin	0032 166	• Tube for auxiliary train wheel bridge
0013 975	• Dial leg pin	0032 165	• Tube for balance cock (B)
0013 481	• Pin for second reduction wheel and pinion		

• Other parts

Part No.	Name	Part No.	Name
0341 016	• Regulator	0014 417	<ul style="list-style-type: none"> • Diafix upper spring for fourth wheel and pinion • Diafix upper spring for escape wheel and pinion
0344 080	• Regulator pointer		
0345 010	• Stud holder	0014 634	• Diashock lower frame
0468 003	• Lower hole jewel with frame for jewelled pallet fork and staff	0015 513	• Diafix lower spring for escape wheel and pinion
0014 603	• Diashock upper frame	0015 721	• Diafix upper hole jewel with frame for fourth wheel and pinion
0014 605	• Diashock upper/lower hole jewel with frame	0015 161	• Diafix upper hole jewel with frame for escape wheel and pinion
0014 317	• Diashock upper/lower spring	0015 531	• Diafix lower hole jewel with frame for escape wheel and pinion

PARTS CATALOGUE



Cal. 4S77A

- ⑦ Framework for automatic device
- ②② Hour wheel
- ⑥① Second wheel pinion
- ⑦⑦ Center wheel and pinion

• **Discrimination of the hand installation height**

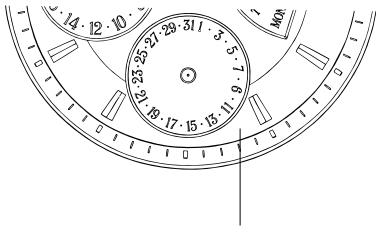
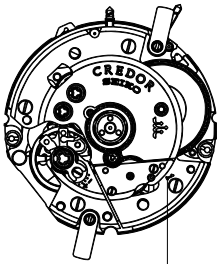
Cal. 4S77A watches have numerals printed on the dial and movement to indicate the hand installation height. When repairing, refer to the tables below.

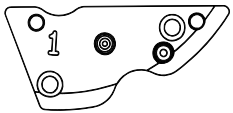
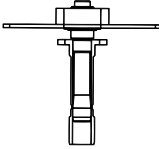
Discrimination	Height	Short type	
	Numeral for discrimination	1	
	Printed on	Dial	Movement
	Printed position	<p>Ex.) Short type</p>  <p>Please see the rightmost numeral printed on the dial.</p>	<p>Ex.) Short type</p>  <p>Please see the numeral printed on the movement.</p>

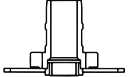
Numeral for discrimination	Framework for automatic device	Center wheel and pinion with cannon pinion	Second wheel pinion	Hour wheel
1 (short type)	 <p>0191 270</p>	 <p>0224 288</p>	 <p>0245 017</p>	 <p>0271 487</p>

- ⑦⑦ Winding stem 0354 132

The type of winding stem is determined based on the design of cases. Check the case number and refer to "SEIKO Casing Parts Catalogue" to choose a corresponding winding stem.

- The explanation here is only for the particular points of Cal. 4S77A.

I. REMARKS ON DISASSEMBLING AND REASSEMBLING

● How to install the hands

① 24-hour hand

Install the 24-hour hand so that its center is positioned within the range indicated in the illustration at right.

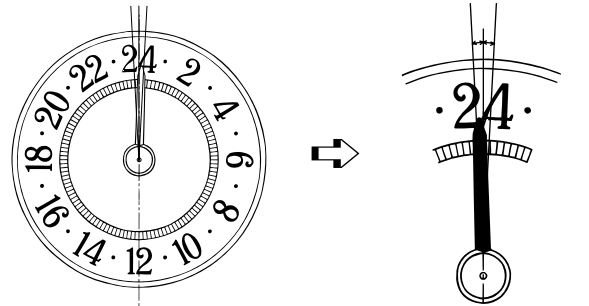

② Date hand

Install the date hand so that its center is positioned within the range indicated in the illustration at right.

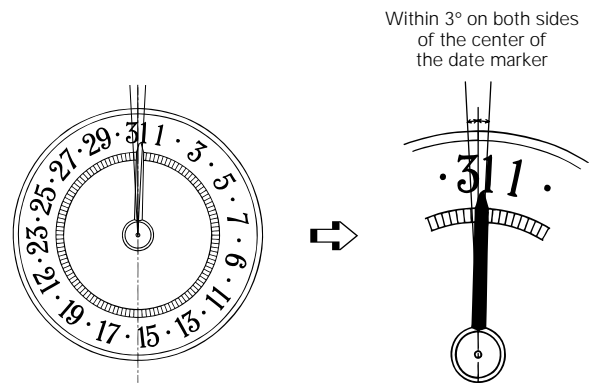

② Day hand

Install the day hand so that the tip of the hand is positioned within the height of the day marker as shown in the illustration at right.

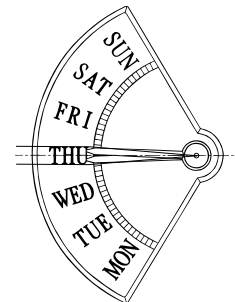

1. Adjust the day hand until the end portion of the hammer engages with the cam of the intermediate day driving wheel in the manner as shown in the illustration at right.
2. Install the dial.
* In doing so, take care not to move the parts from their respective positions indicated in the illustration.
3. Install the date and day hands.
In doing so, pull out the winding stem for hour hand adjustment at the 2 o'clock side to the first click position, and check that the day hand does not touch the dial.
4. Pull out the winding stem at the 3 o'clock side to the second click position, and turn it counterclockwise until the date changes to the next.
5. Install the 24-hour hand at the "24" position and the hour, minute and second hands at the 12 o'clock position, respectively.

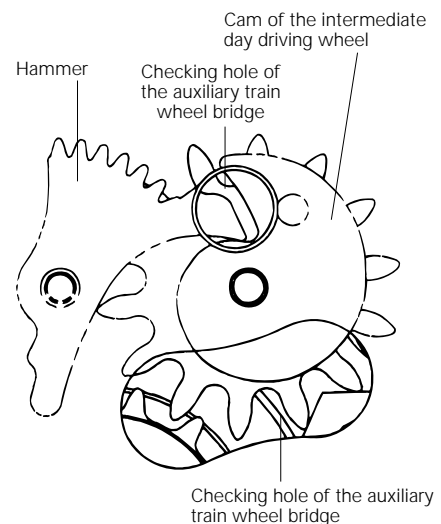

● **Setting position of the day wheel**

Slide the hammer so that it engages with the pinion of the day wheel as shown in the illustration below.

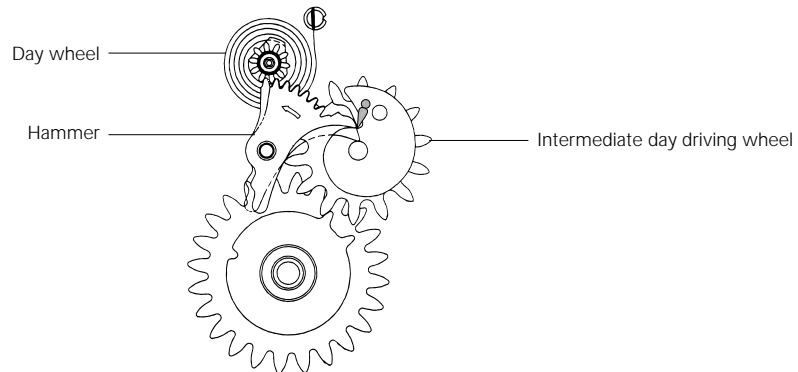

● **Setting position of the date driving wheel and day indicator driving wheel**

- Check that the notched portion of the day driving wheel aligns with a tooth of the intermediate day driving wheel.
- Set the day driving wheel so that the midpoint between its two protrusions aligns with the center of the hour wheel.
- Set the date driving wheel so that its protrusion aligns with the indented portion on the auxiliary plate.
- Check that the notched portion of the date driving wheel aligns with a tooth of the date star.

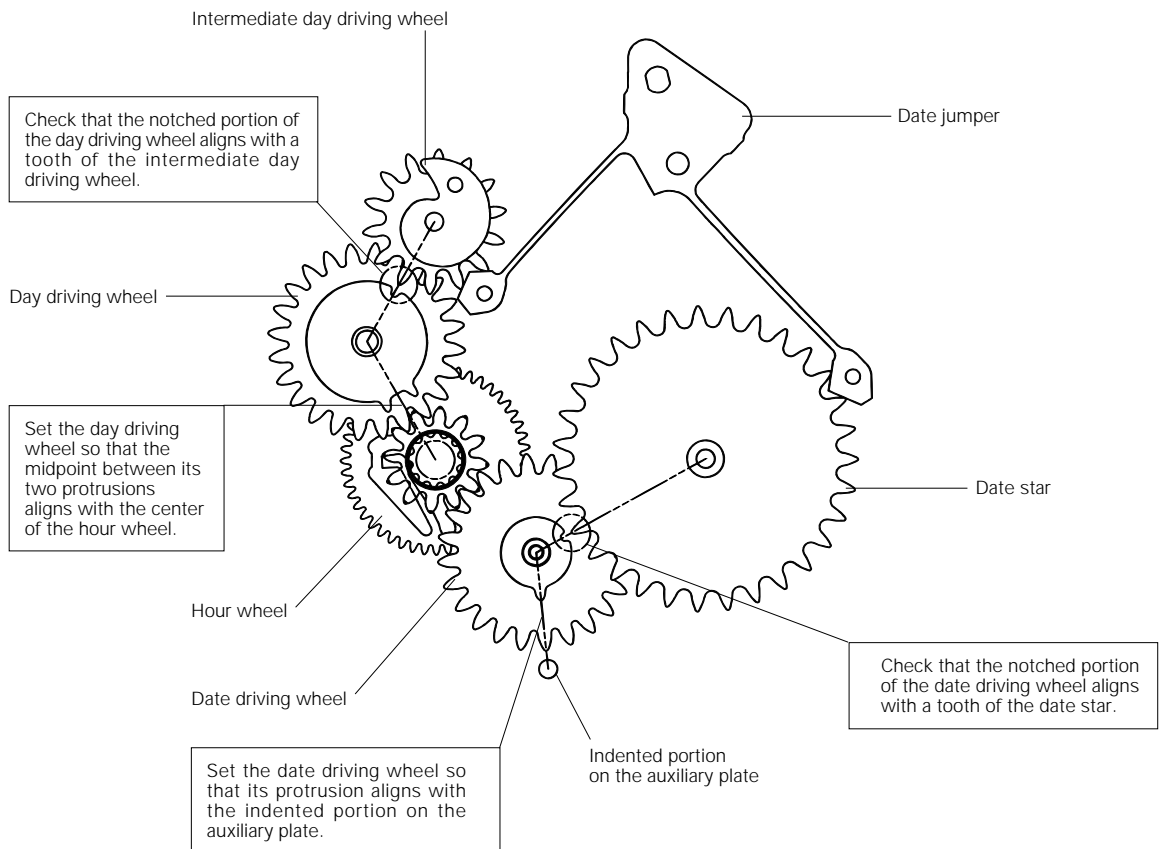

5 Oscillating weight with ball bearing

• How to remove and install

A screwdriver having a tip as shown in the illustration at right is convenient for removing or installing the oscillating weight with ball bearing.

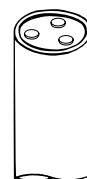

9 First reduction wheel and pinion

• How to remove

Before removing the first reduction wheel and pinion, be sure to unwind the mainspring. To do so, move the click in the direction of the arrow with tweezers as shown in the illustration at right while turning the crown gently counterclockwise. If the click is moved without turning the crown counterclockwise, the mainspring will be unwound forcibly all at once and may cause the mainspring to be damaged.

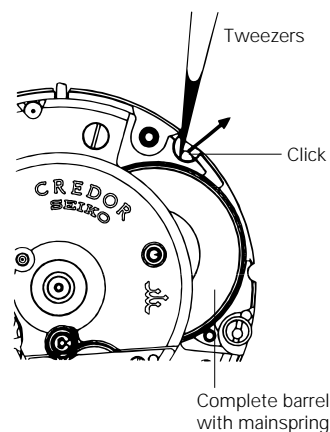

11 Auxiliary train wheel bridge

• Setting position

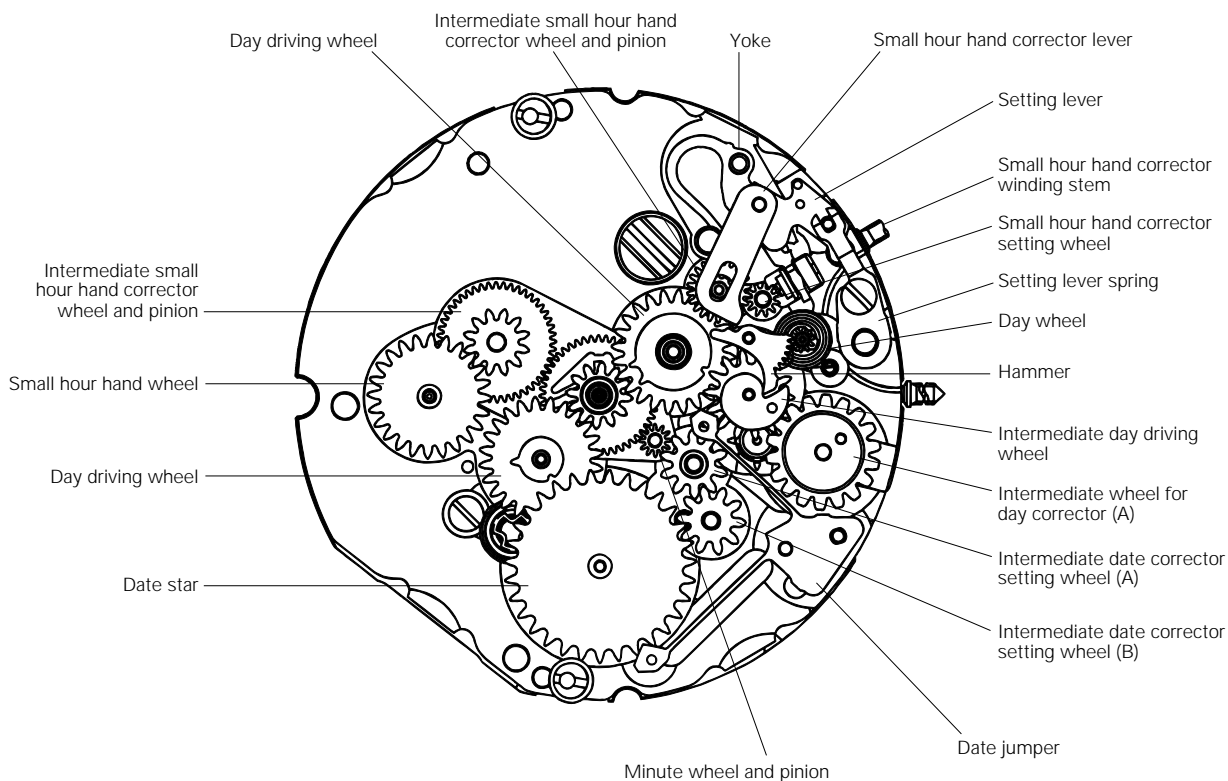

38 Minute wheel bridge

• **Lubricating**

Lubricate the crown wheel of the minute wheel bridge at the portion indicated in the illustration below.

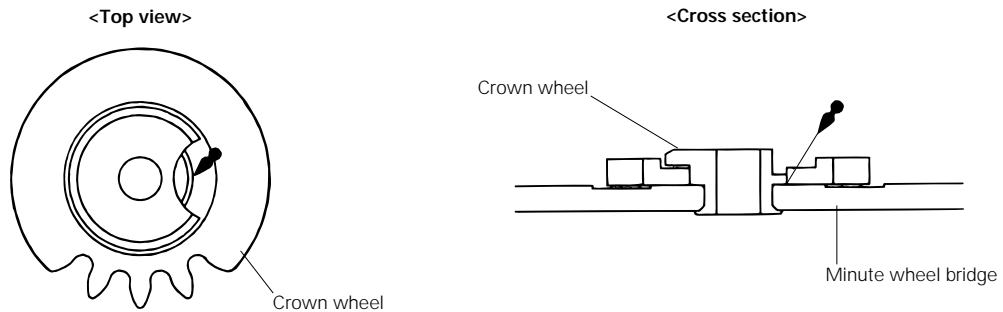

55 Jewelled pallet fork and staff

• **Lubricating**

Lubricate the jewelled pallet fork and staff at the portion indicated in the illustration below. When doing so, do not apply more oil than required or apply it to any other portion than specified, lest the oil should drip.

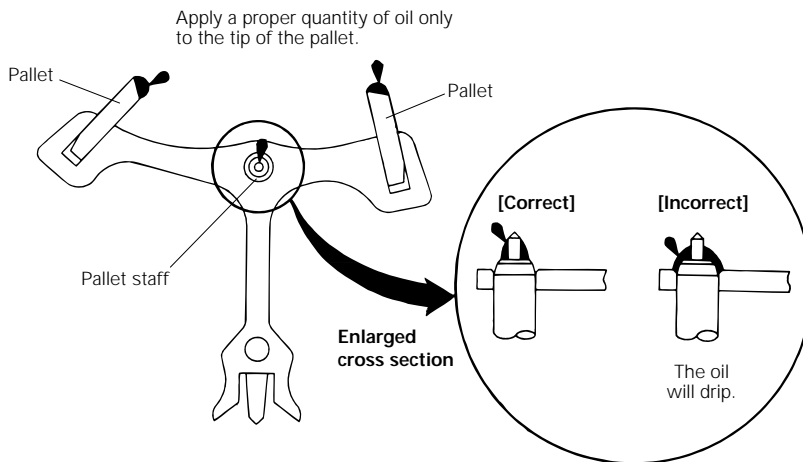

60 Friction spring for second wheel pinion

• **How to install**

Do not set the friction spring to the second wheel pinion from above the pinion portion, as the spring will not fit in position. Instead, insert the spring from sideways as shown in the illustration. After installing it, check if it is set in position.

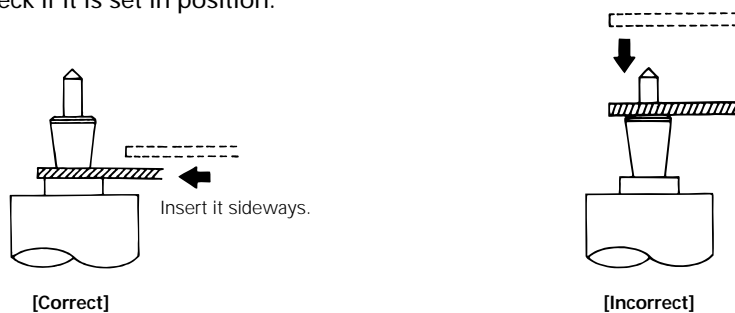

61 Second wheel pinion

• **Lubricating**

Lubricate the upper portion of the second wheel pinion as shown in the illustration at right.

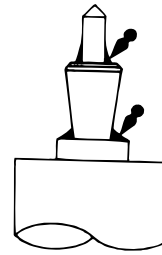

63 Complete barrel with mainspring

• **Lubricating**

It is not necessary to disassemble the complete barrel with mainspring. If it is disassembled for cleaning purposes, lubricate 2 to 3 portions inside the barrel with SEIKO Watch Oil S-3.

<Top view>

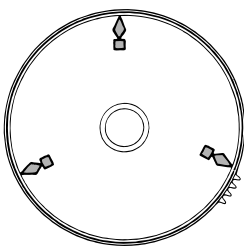

<Cross section>



65 Center wheel bridge

• **Lubricating**

Lubricate the first reverser idler of the center wheel bridge at the portion indicated in the illustration below.

<Top view>

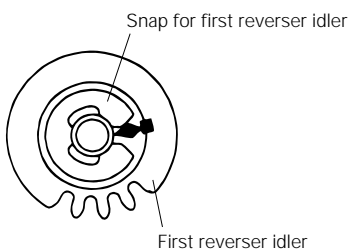

<Cross section>

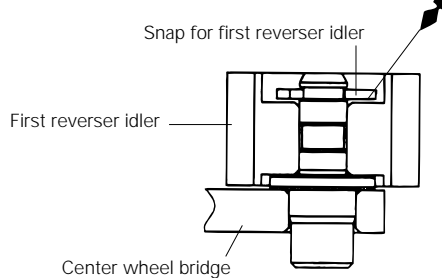

80 Main plate

• **Lubricating**

Lubricate the second reduction wheel at the portion indicated in the illustration below.

<Top view>

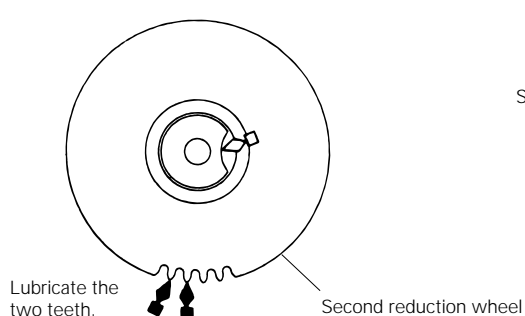

<Cross section>

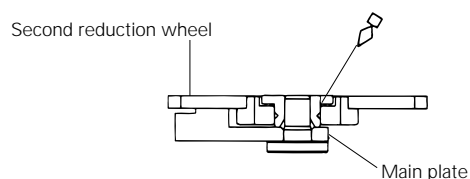

II. REFERENCE

● How to wind the main spring

• Manual winding mechanism

By turning the crown clockwise while the winding pinion and sliding crown wheel engage with each other (while the crown is at the normal or first click position), the ratchet wheel will turn intermediated by the sliding crown wheel, thus winding the mainspring. By turning the crown counterclockwise, however, the crown wheel will be disengaged from the sliding crown wheel, and the mainspring will not be wound. The crown wheel and sliding crown wheel are also disengaged when the mainspring is wound through the automatic winding mechanism.

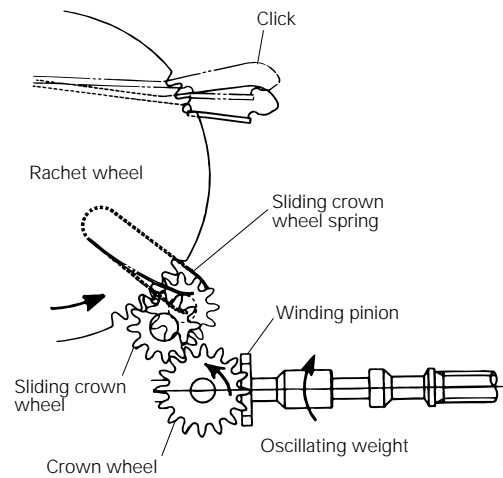

• Automatic winding mechanism

Regardless of whether the oscillating weight turns clockwise or counterclockwise, the differential wheel and pinion keeps the wheels turning only in one fixed direction so that the mainspring will be wound as the oscillating wheel turns.

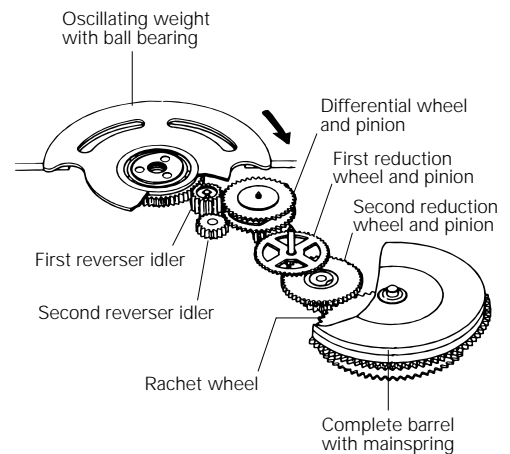
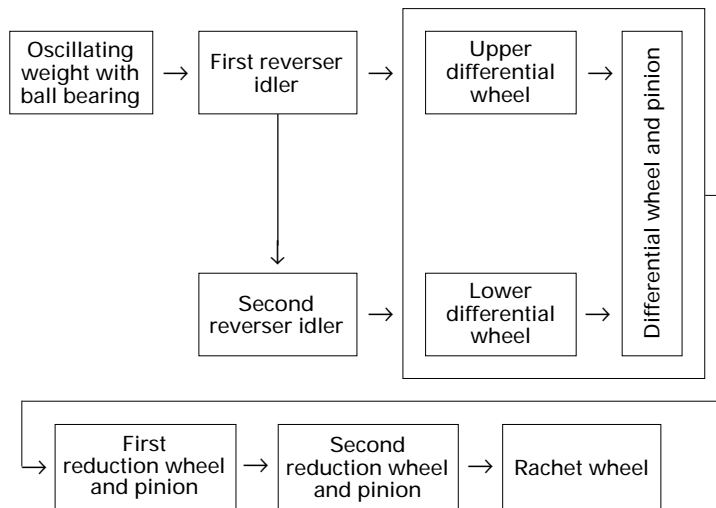

● Second setting device

When the crown is pulled out to the second click, the pin at the end of the train wheel setting lever presses down the balance complete with stud, thus stopping the hands.

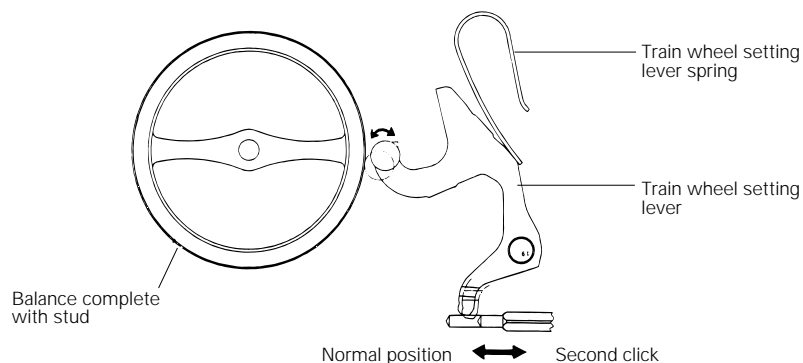

TECHNICAL GUIDE

Cal. 4S77A

● Regulating device by micro-positioning regulator pin

The accuracy of the watch can be adjusted by moving the lever attached to the regulator device as shown in the illustration to extend or reduce the clearance between the regulator key and regulator pin. After replacing the balance complete with stud, be sure to adjust the accuracy using the lever. Except in such a case, however, do not move the lever, as the accuracy of the watch has been adjusted at the factory before shipment.

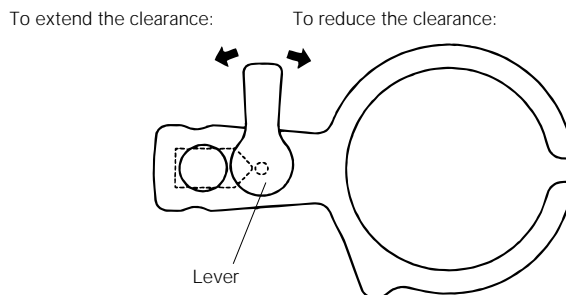

HOW TO OPERATE

Cal. 4S77A

● Dual time indication

(Ex.:When you travel abroad)

Time of the place you visit

Time back home
(24-hour hand)

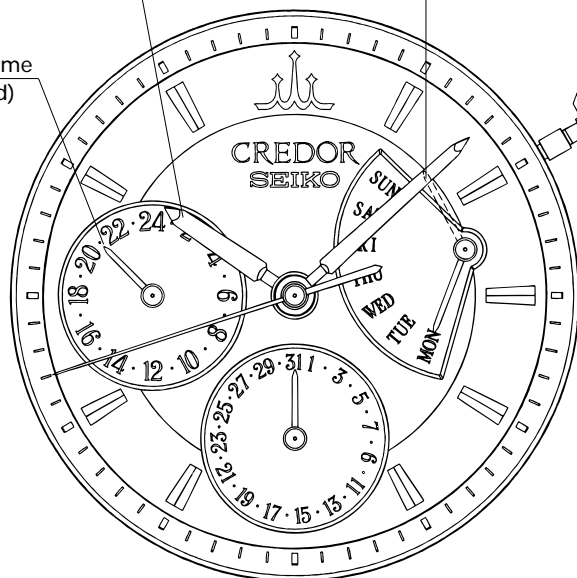

● Position of the day hand during hour hand adjustment

If the crown for hour hand adjustment is left at the first click position, the hour hand will not advance properly. To prevent this, the day hand points outside the day dial while the crown is at the first click position, to signal the crown position. After the hour hand adjustment is completed, make sure that the crown is pushed back in to the normal position, checking that the day hand points to a day of the week.

Crown for hour hand adjustment

- Normal position
Will not work
- First click position
Turning clockwise:
Advances the hour hand
Turning counterclockwise:
Moves back the hour hand

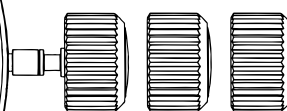

- 1) Normal position
- 2) First click position
- 3) Second click position

1) Normal position

Turning clockwise:
Winding the main spring
Turning counterclockwise:
Will not work

2) First click position

(for calendar setting)
Turning clockwise:
Winding the main spring and changing the day of the week (Two clicks change the day) (The day will not change between 21:30 and 2:00.)
Turning counterclockwise:
Changing the date (The date will not change between 21:10 and 1:20.)

3) Second click position

(for time setting)
Turning clockwise:
Moves back the minute and 24 hour hands (Will not move back the hands around 12:00 midnight on Monday)
Turning counterclockwise:
Advancing the minute and 24-hour hands

