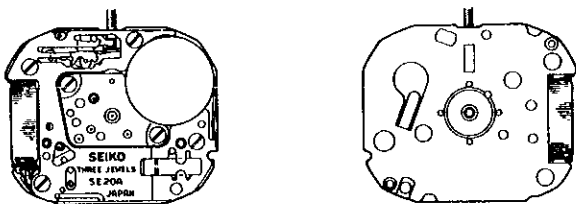

PARTS CATALOGUE/ TECHNICAL GUIDE

Cal. 5E20A

[SPECIFICATIONS]

Item		Cal. No.	5E20A
Movement		 <p style="text-align: right;">(x 1.5)</p>	
Movement size	Outside diameter	$\phi 20.0$ mm 15.4 mm between 3 o'clock and 9 o'clock sides 18.5 mm between 6 o'clock and 12 o'clock sides	
	Casing diameter	$\phi 19.5$ mm 15.0 mm between 3 o'clock and 9 o'clock sides 18.5 mm between 6 o'clock and 12 o'clock sides	
	Height	1.6 mm	
Time indication		2 hands (Hand motion: 20-second step)	
Driving system		Step motor (Load compensated driving pulse type)	
Additional mechanism		<ul style="list-style-type: none"> • Electronic circuit reset switch • Train wheel setting device 	
Loss/gain		Monthly rate at normal temperature range: less than ± 15 seconds	
Regulation system		Nil	
Measuring gate by quartz tester		Use 10-second gate.	
Battery		SEIKO SR716SW, Matsushita SR716SW Battery life is approximately 3 years. Voltage: 1.55V	
Jewels		3 jewels	

HATTORI SEIKO CO., LTD.

PARTS CATALOGUE

Cal. 5E20A

Disassembling procedures Figs.: ① → ②⑥

Reassembling procedures Figs.: ②⑥ → ①

Lubricating: Types of oil

● Moebius A

⊖ SEIKO Watch Oil S-6

Oil quantity

∞ Normal quantity

○ Extremely small

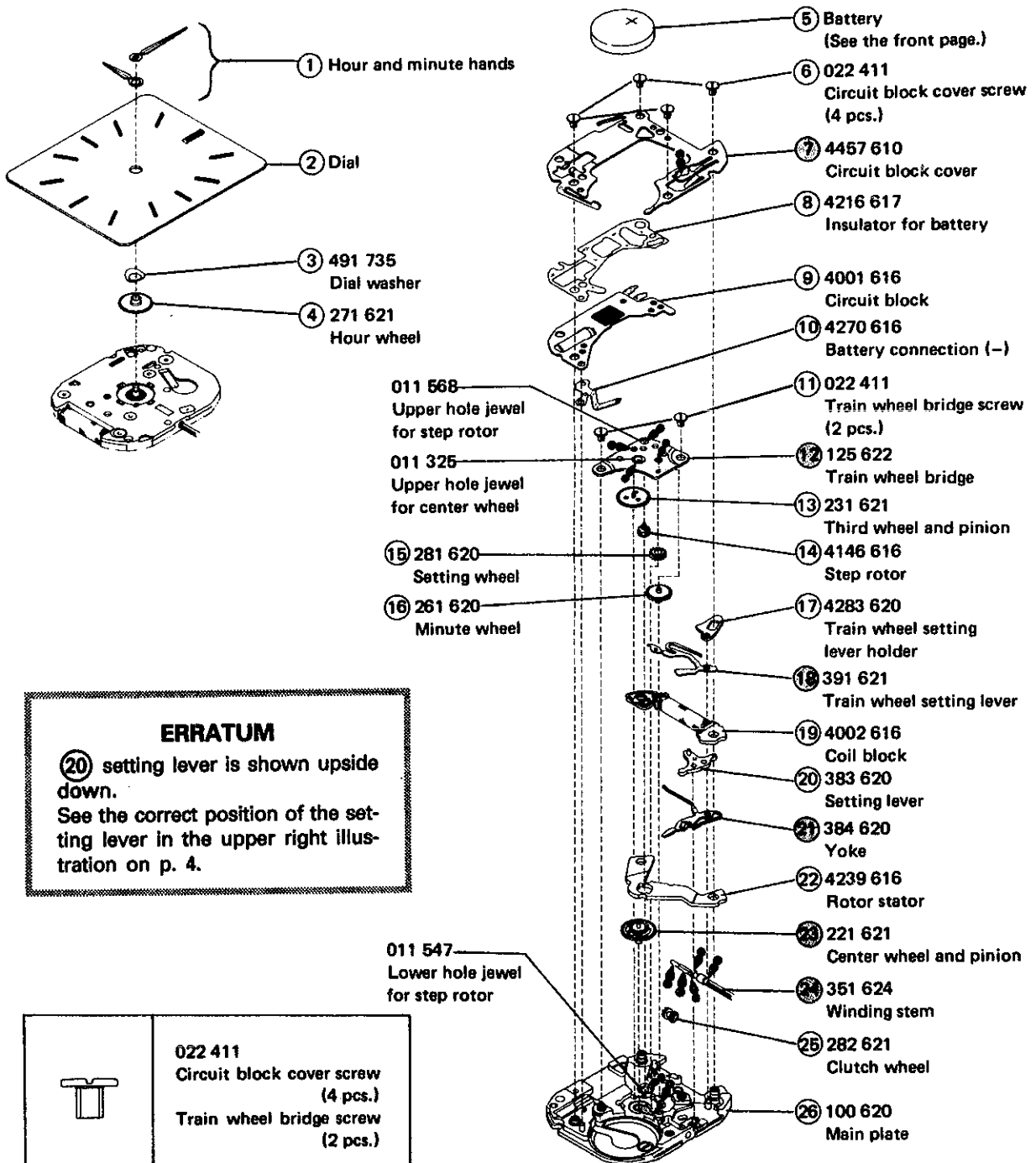

ERRATUM

⑳ setting lever is shown upside down.
See the correct position of the setting lever in the upper right illustration on p. 4.

	<p>022 411 Circuit block cover screw (4 pcs.)</p> <p>Train wheel bridge screw (2 pcs.)</p>
--	--

⊖ ⇨ Please see the remarks on the following pages.

Remarks:

②④ Winding stem

The type of winding stem is determined based on the design of cases.
Check the case number and refer to "SEIKO Casing Parts Catalogue" to choose a corresponding winding stem.

TECHNICAL GUIDE

- The explanation here is only for the particular points of Cal. 5E20A.
- For the repairing, checking and measuring procedures, refer to the "TECHNICAL GUIDE, GENERAL INSTRUCTIONS".

I. STRUCTURE OF THE CIRCUIT BLOCK

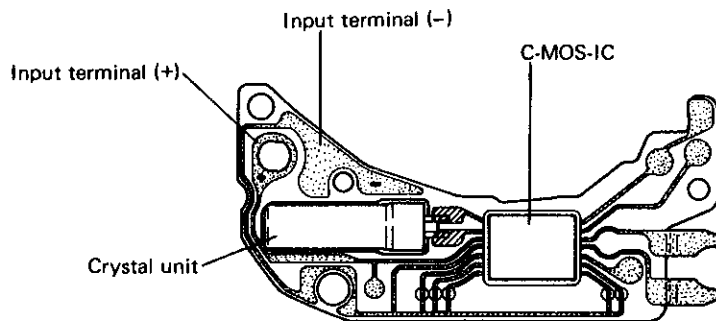

II. REMARKS ON DISASSEMBLING AND REASSEMBLING

Use the universal movement holder for disassembling and reassembling. Since this is a thin caliber, be careful not to deform the movement. It is recommended that a flat metal plate or the like be used to place the movement.

⑦ Circuit block cover

• **Installing**

After tightening the circuit block cover screws (4 pcs.), set the circuit block cover in position to the setting lever pin by pressing it in the direction of the arrow as shown in the illustration on the right.

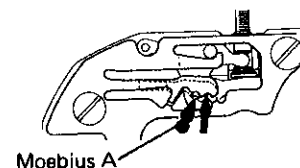

⑫ Train wheel bridge

• **Setting position**

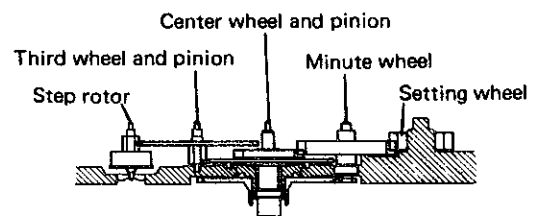
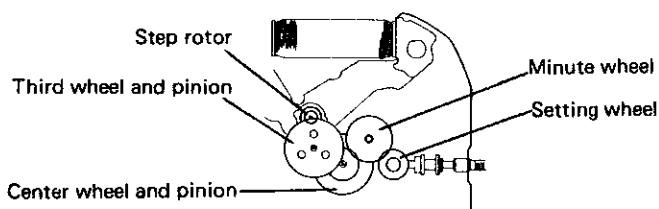

18 Train wheel setting lever

- **Installing**

Set the train wheel setting lever into position by pressing its spring portion in the direction of the arrow as shown in the illustration on the right.

Note: Be careful not to scratch the rotor stator or break coil wires.

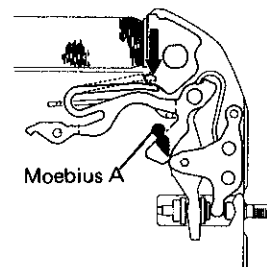

21 Yoke

- **Installing**

Set the yoke as shown in the illustration on the right.

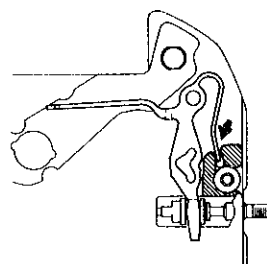

23 Center wheel and pinion

- **Lubricating**

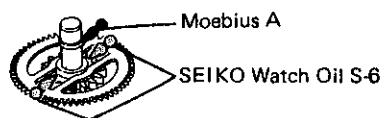

III. VALUE CHECKING

- **Coil block resistance**

1.2K Ω ~ 1.8K Ω

- **Current consumption**

For the whole of the movement: less than 0.8 μ A

For the circuit block alone : less than 0.6 μ A

Remarks:

When the current consumption exceeds the standard value for the whole of the movement but is less than the standard value for the circuit block alone, overhaul and clean the movement parts and then measure current consumption for the whole of the movement again.