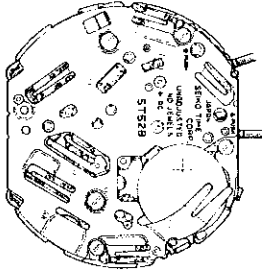
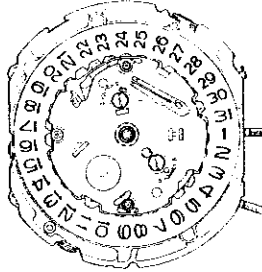

PARTS CATALOGUE / TECHNICAL GUIDE

Cal. 5T32B

Cal. 5T52B

[SPECIFICATIONS]

Item		Cal. No.	5T32B	5T52B	
Movement					
			The illustrations refer to Cal. 5T52B. (x 1.5)		
Movement size	Outside diameter		ø27.6mm 24.0mm between 3 o'clock and 9 o'clock sides		
	Casing diameter		ø27.0mm 24.0mm between 3 o'clock and 9 o'clock sides		
	Height		3.2mm		
Time indication			Main time	Alarm	
			Hour and minute hands Second hand (Cal. 5T32B) Small second hand (Cal. 5T52B)	Small hour and minute hands (12-hour indication system)	World time (Cal. 5T52B) City hand Small hour and minute hands (24-hour indication system)
Driving system			Step motor, 2 pieces for Cal. 5T32B / 4 pieces for Cal. 5T52B		
Additional mechanism			<ul style="list-style-type: none"> • Electronic circuit reset switch • Train wheel setting device • Battery life indicator (Second hand (Cal. 5T32B) / small second hand (Cal. 5T52B) moves at two-second intervals.) • Date calendar • Instant setting device for date calendar • Alarm function (12-hour indication system) <ul style="list-style-type: none"> • Regular alarm • Single-time alarm • World time function (24-hour indication system) (Cal. 5T52B) <ul style="list-style-type: none"> • Selection among 24 cities in different time zones 		
Loss/gain			Monthly rate at normal temperature range: less than 15 seconds		
Regulation system			Nil		
Measuring gate by quartz tester			Use 10-second gate.		
Battery			SEIKO SR927W, Maxell SR927W, SONY SR927W, EVEREADY 399 Battery life is approximately 2 years. Voltage: 1.55V		
Jewels			0 jewel		

SEIKO CORPORATION

PARTS CATALOGUE

Cal. 5T32B

Disassembling procedures Figs. : ① → ⑥⑥

Reassembling procedures Figs. : ⑥⑥ → ①

Lubricating: Types of oil

● Moebius A

○ SEIKO Watch Oil S-6

Oil quantity

○ Normal quantity

○ Extremely small

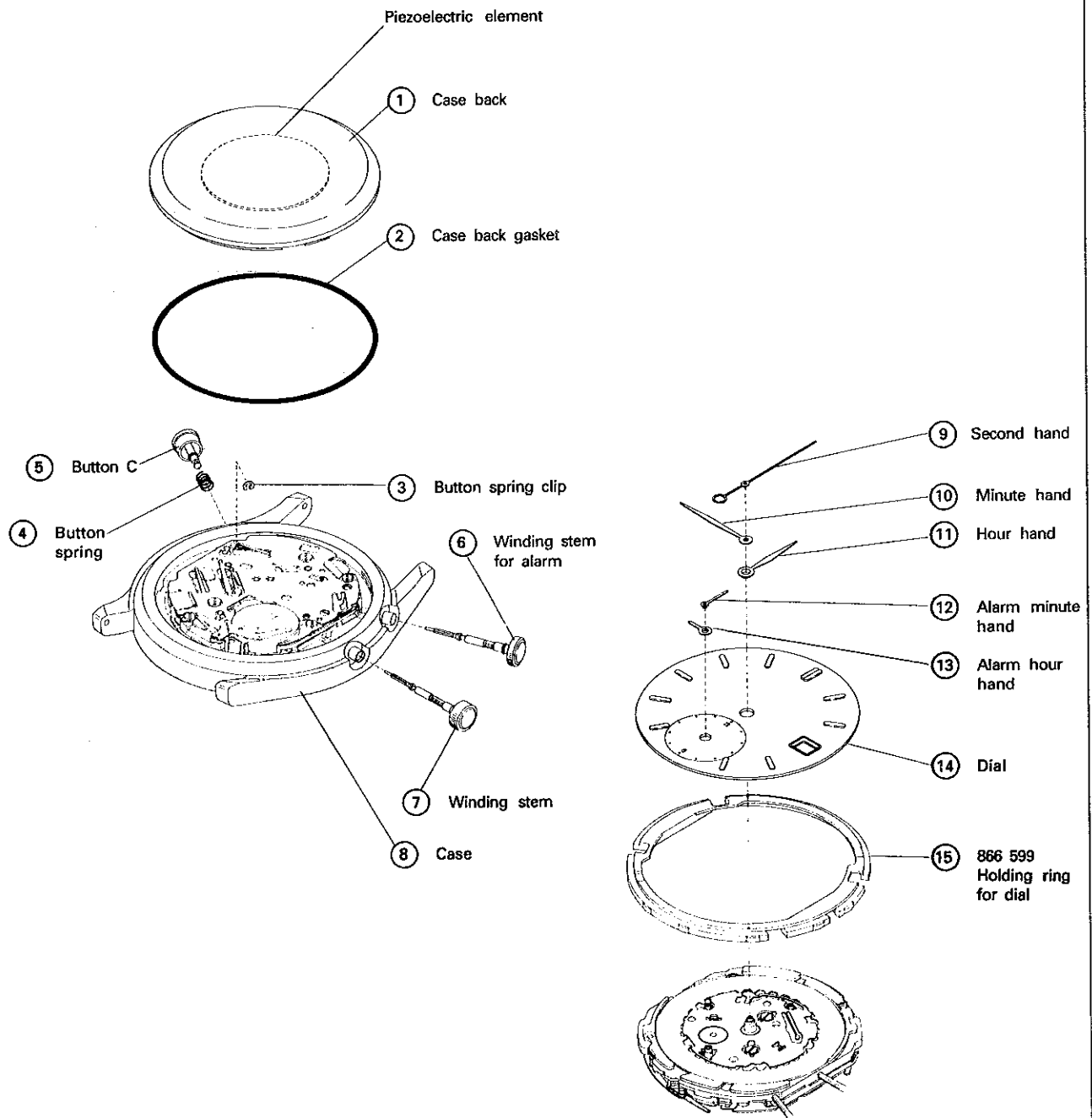

○ ⇨ Please see the remarks on the following pages.

PARTS CATALOGUE

Cal. 5T32B

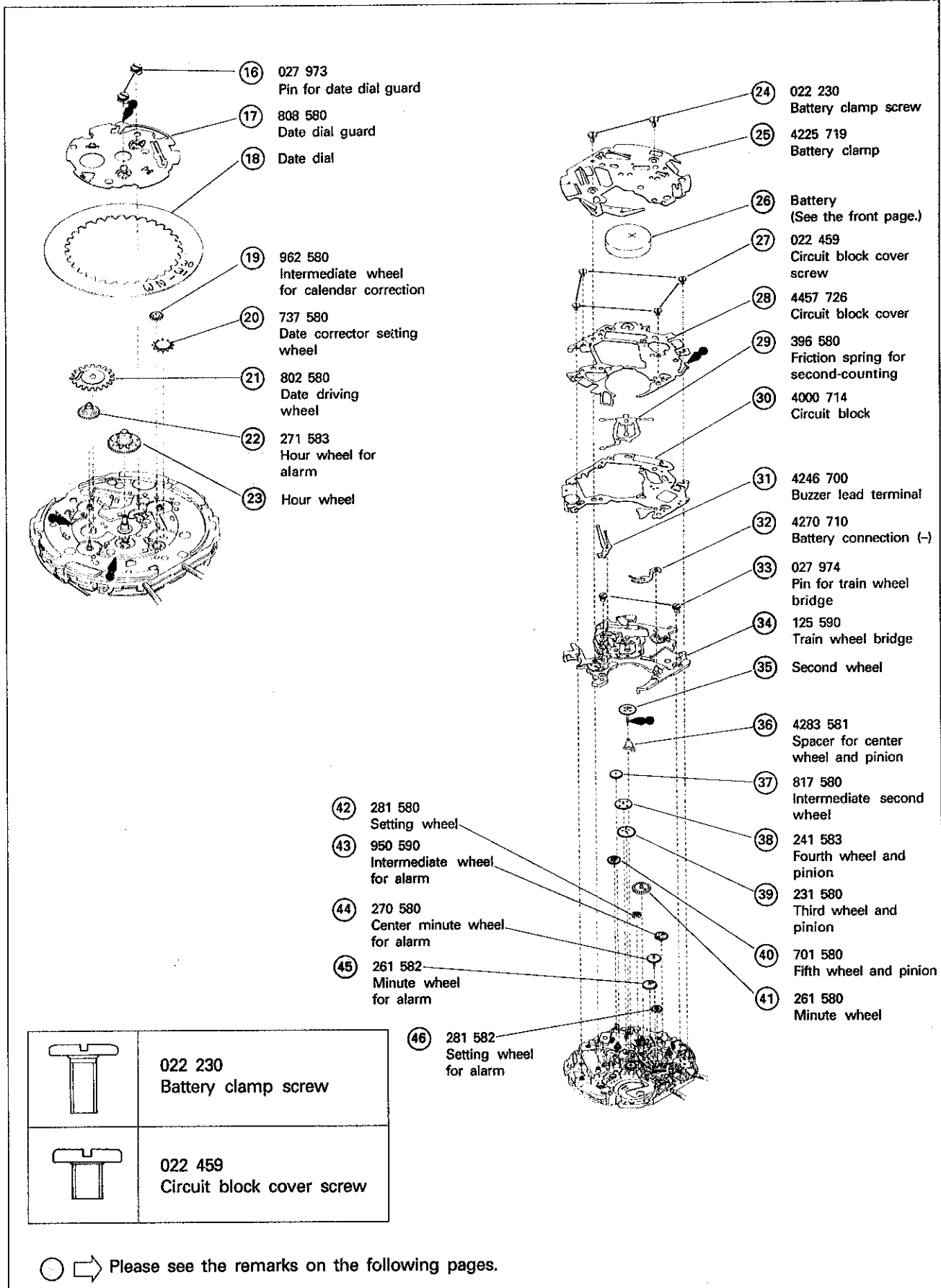

- 16 027 973
Pin for date dial guard
- 17 808 580
Date dial guard
- 18 Date dial
- 19 962 580
Intermediate wheel
for calendar correction
- 20 737 580
Date corrector setting
wheel
- 21 802 580
Date driving
wheel
- 22 271 583
Hour wheel for
alarm
- 23 Hour wheel

- 24 022 230
Battery clamp screw
- 25 4225 719
Battery clamp
- 26 Battery
(See the front page.)
- 27 022 459
Circuit block cover
screw
- 28 4457 726
Circuit block cover
- 29 396 580
Friction spring for
second-counting
- 30 4000 714
Circuit block
- 31 4246 700
Buzzer lead terminal
- 32 4270 710
Battery connection (-)
- 33 027 974
Pin for train wheel
bridge
- 34 125 590
Train wheel bridge
- 35 Second wheel
- 36 4283 581
Spacer for center
wheel and pinion
- 37 817 580
Intermediate second
wheel
- 38 241 583
Fourth wheel and
pinion
- 39 231 580
Third wheel and
pinion
- 40 701 580
Fifth wheel and pinion
- 41 261 580
Minute wheel

- 42 281 580
Setting wheel
- 43 950 590
Intermediate wheel
for alarm
- 44 270 580
Center minute wheel
for alarm
- 45 261 582
Minute wheel
for alarm

- 46 281 582
Setting wheel
for alarm

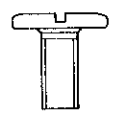
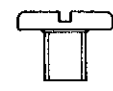
	022 230 Battery clamp screw
	022 459 Circuit block cover screw

○ → Please see the remarks on the following pages.

PARTS CATALOGUE

Cal. 5T32B

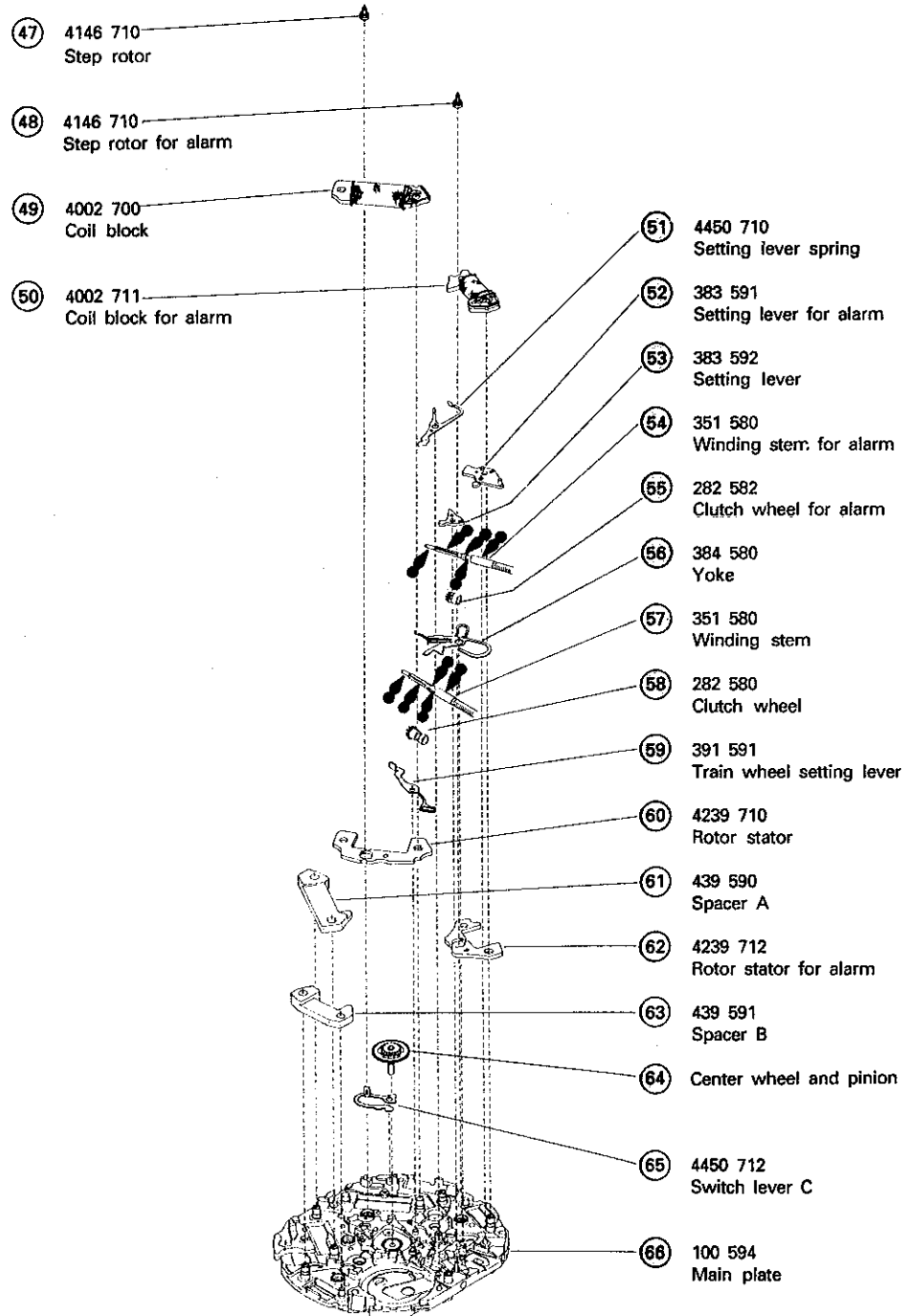

○ ⇨ Please see the remarks on the following pages.

PARTS CATALOGUE

Cal. 5T52B

Disassembling procedures Figs. :

1 → 84

Reassembling procedures Figs. :

84 → 1

Lubricating: Types of oil

Oil quantity

● Moebius A

∞ Normal quantity

∞ SEIKO Watch Oil S-6

∞ Extremely small

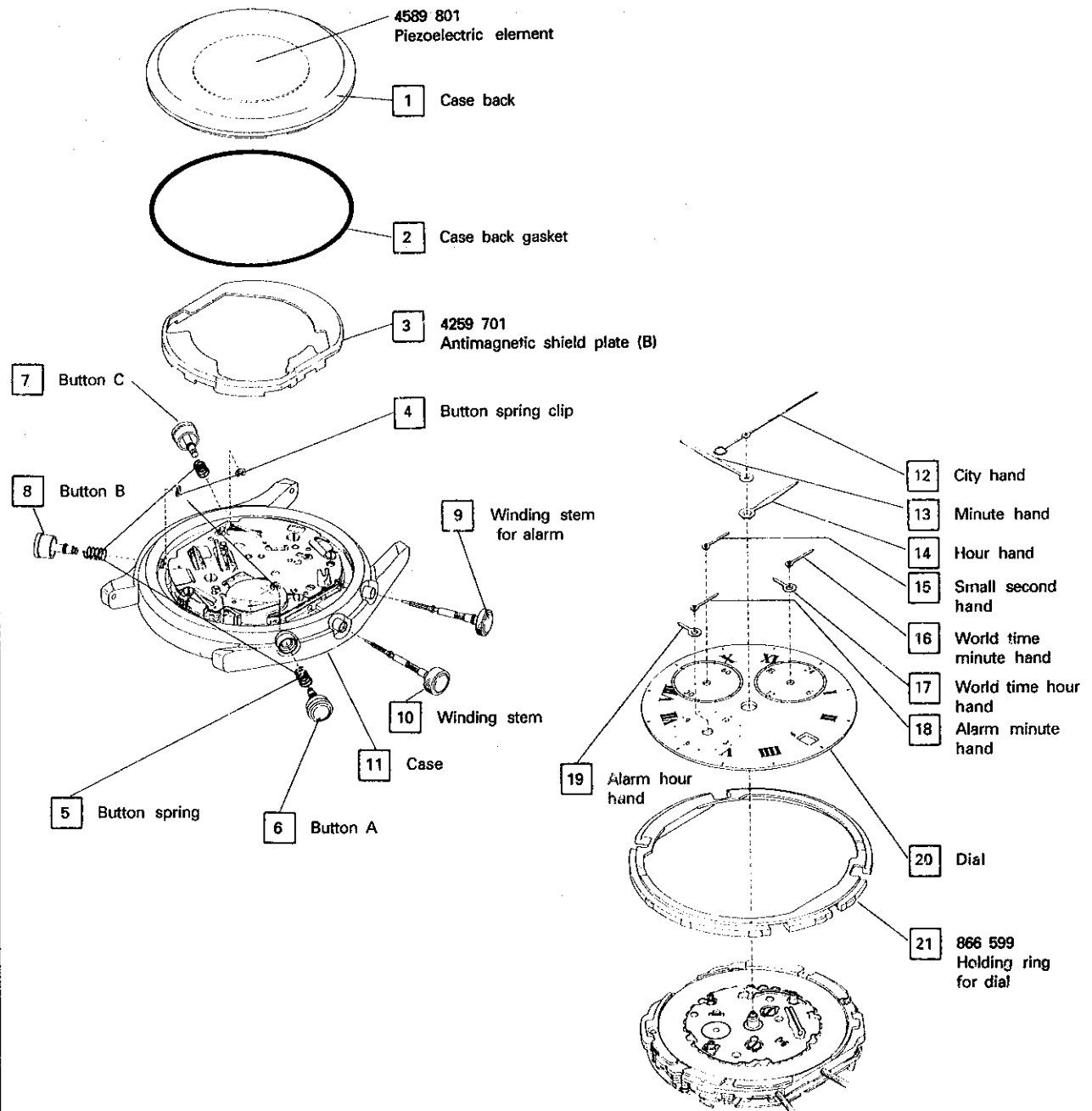

□ ⇨ Please see the remarks on the following pages.

PARTS CATALOGUE

Cal. 5T52B

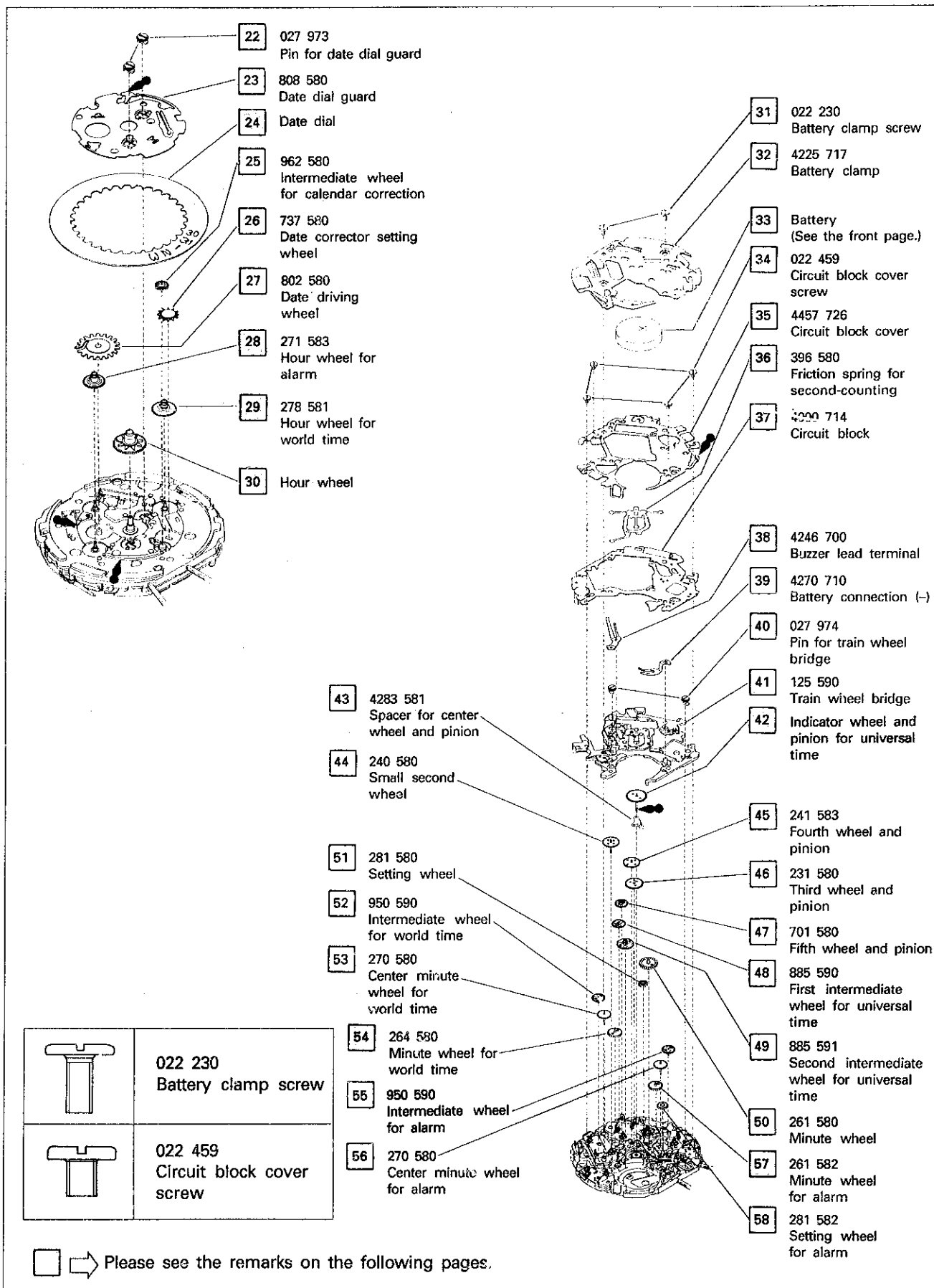

PARTS CATALOGUE

Cal. 5T52B

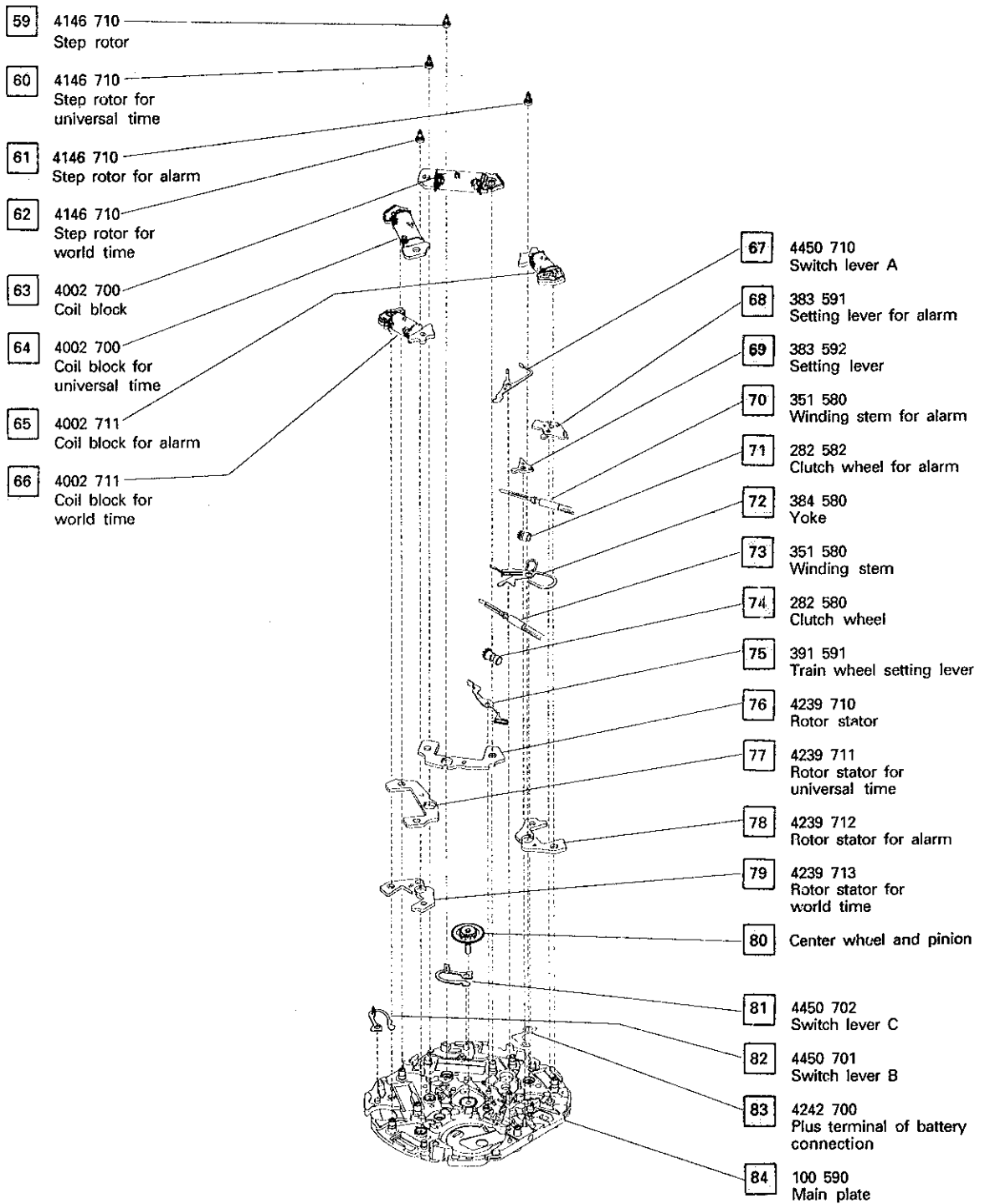

➔ Please see the remarks on the following pages.

PARTS CATALOGUE

Cal. 5T32B, 5T52B

Remarks:

○ Cal. 5T52B and 7T42B are almost the same in structure but different in function. Therefore, some of the parts are named differently depending on calibres though they can be used interchangeably. There are also some parts that are not used with Cal. 7T42B but only with Cal. 5T52B.

- Parts used only with Cal. 5T52B

Part code	Part name
264 580	Minute wheel for world time
278 581	Hour wheel for world time
4242 700	Plus terminal of battery connection

- Parts named differently depending on calibres

Part code	Part name for Cal. 7T42B	Part name for Cal. 5T52B
885 590	First intermediate wheel for second-counting	First intermediate wheel for universal time
885 591	Second intermediate wheel for second-counting	Second intermediate wheel for universal time
888 580 888 582	Second-counting wheel	Indicator wheel and pinion for universal time
950 590	Intermediate minute-counting wheel	Intermediate wheel for world time
4002 700	Coil block for chronograph second Coil block for chronograph minute	Coil block for universal time Coil block for world time
4146 710	Chronograph rotor for second Chronograph rotor for minute	Step rotor for universal time Step rotor for world time
4239 711	Rotor stator for chronograph second	Rotor stator for universal time
4239 713	Rotor stator for chronograph minute	Rotor stator for world time

- Different parts used in the same position

Cal. 7T42B	Cal. 5T52B
902 580	270 580
Minute-counting wheel	Center minute wheel for world time

○ Cal. 5T32B and 5T52B have the same functions except that Cal. 5T52B has a world time function.

- Parts newly added for Cal. 5T32B

Part code	Part name
240 583	Second wheel
240 585	Second wheel
439 590	Spacer A
439 591	Spacer B
817 580	Intermediate second wheel
4450 710	Setting lever spring (interchangeable with switch lever A of Cal. 5T52B)

PARTS CATALOGUE

Cal. 5T32B, 5T52B

- Parts with different part code

	Cal. 5T52B	Cal. 5T32B
Main plate	100 590	100 594

- Parts used only with Cal. 5T52B

Part code	Part name
240 580	Small second wheel
264 580	Minute wheel for world time
270 580	Center minute wheel for world time
278 581	Hour wheel for world time
885 590	First intermediate wheel for universal time
885 591	Second intermediate wheel for universal time
888 580	Indicator wheel and pinion for universal time
888 582	
950 590	Intermediate wheel for world time
4002 700	Coil block for universal time
4002 711	Coil block for world time
4146 710	Step rotor for universal time
4146 710	Step rotor for world time
4239 711	Rotor stator for universal time
4239 713	Rotor stator for world time
4242 700	Plus terminal of battery connection
4259 701	Antimagnetic shield plate (B)
4450 710	Switch lever A
4457 701	Switch lever B

- ⑮ 21 Holding ring for dial

The type of holding ring for dial is determined based on the design of cases. Check the case number and refer to "SEIKO Casing Parts Catalogue" to choose a corresponding holding ring for dial.

- ⑱ 24 Date dial

PART NUMBER	CALENDAR POSITION	CROWN POSITION	BACKGROUND COLOR	FIGURE COLOR
878 527	3 o'clock	3 o'clock or near 4 o'clock	White	Black (slender letter)
878 571	↓	↓	↓	↓ (thin letter)
878 529	↓	↓	Black	Gold
878 528	↓	↓	Gold	Black

The type of date dial is determined based on the design of cases. Check the case number and refer to "SEIKO Casing Parts Catalogue" to choose a corresponding date dial.

PARTS CATALOGUE

Cal. 5T32B, 5T52B

- ②② ②⑧ Hour wheel for alarm
- ②⑨ Hour wheel for world time

For distinction between the two hour wheels, see the illustration below.

[Hour wheel for world time]

[Hour wheel for alarm]



278 581



271 583

- ②③ ③① Hour wheel
- ④② Indicator wheel and pinion for universal time
- ③⑤ Second wheel
- ⑥④ ⑧① Center wheel and pinion

Combination

Part name Type*	Hour wheel	Indicator wheel and pinion for universal time (Cal. 5T52B)	Second wheel (Cal. 5T32B)	Center wheel and pinion
S	 271 580	 888 580	 240 583	 221 580
M	 271 588	 888 582	 240 585	 221 583

*Abbreviation
(Movement type) S Short type
M Standard type

PARTS CATALOGUE

Cal. 5T32B, 5T52B

③⑩ ③⑦ Circuit block

See the illustration below to identify the circuit block for Cal. 5T32B and 5T52B.

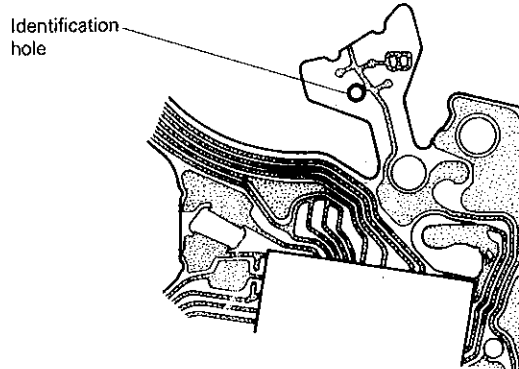

④⑤ ⑤⑦ Minute wheel for alarm

⑤④ Minute wheel for world time

For distinction between the wheels, see the illustration below.

[Minute wheel for world time]

[Minute wheel for alarm]

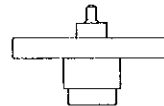
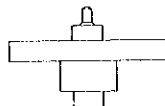

264 580

261 582

⑤④ ⑦⑩ Winding stem for alarm 351 580

⑤⑦ ⑦③ Winding stem

The type of winding stem for alarm and winding stem are determined based on the design of cases. Check the case number and refer to "SEIKO Casing Parts Catalogue" to choose a corresponding winding stem.

Cal. 5T32B, 5T52B and 7T32B are almost the same in structure.

Differences between Cal. 5T52B and 7T32B

- The specifications of the CPU-IC of Cal. 7T32B have been changed and Cal. 5T52B is equipped with a world time function instead of a stopwatch function.
- Cal. 5T52B has a single-time alarm function as well as a regular alarm function.
- Differences in structure
 - Hour wheel for world time, minute wheel for world time and plus terminal of battery connection are added for Cal. 5T52B.

Differences between Cal. 5T32B and 5T52B

- Cal. 5T32B is not equipped with a world time function.
- Differences in structure
 - Second wheel, intermediate second wheel, spacer A and spacer B are added for Cal. 5T32B.
 - Parts for the world time function are not used in Cal. 5T32B.
- The explanation here is only for the particular points of Cal. 5T32B and 5T52B.
- For the repairing, checking and measuring procedures, refer to the "PARTS CATALOGUE/TECHNICAL GUIDE for Cal. 7T32B, 7T42B" and the "TECHNICAL GUIDE, GENERAL INSTRUCTIONS".

I. REMARKS ON INSTALLING THE BATTERY

- **A necessary step after installing the battery**
 - After the battery is replaced with a new one, or after the battery is re-installed following the repairing procedures, be sure to short-circuit the AC terminal and the circuit block cover with tweezers to reset the circuit as shown in the illustration below.

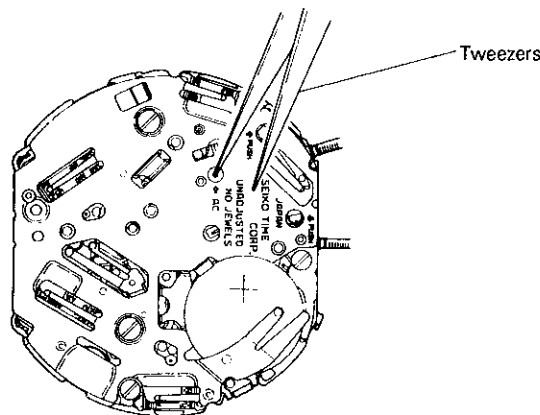

- After resetting the circuit, be sure to adjust the city hand following the procedure below (only for Cal. 5T52B).
 - 1) Pull out the crown at the 3 o'clock side to the second click.
 - 2) Press button "A" or "B" to adjust the city hand to the center of a city marker.

* The hand turns clockwise by pressing button "A" and counterclockwise by pressing button "B".

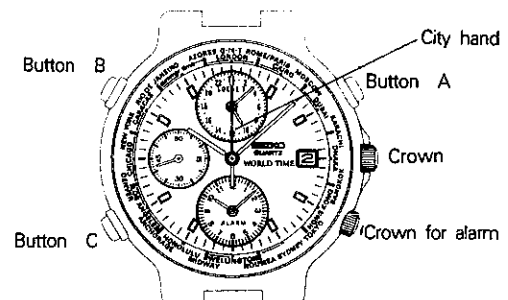

II. REMARKS ON DISASSEMBLING AND REASSEMBLING

83 Plus terminal of battery connection

- **Setting position**

Set the plus terminal of battery connection as shown in the illustration.

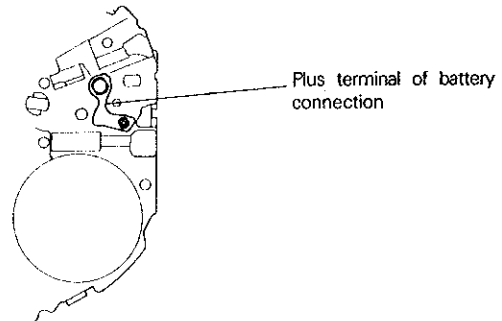

33 **40** Pin for train wheel bridge

- **Lubricating**

After installing the fixing pin for train wheel bridge, lubricate the upper pivot of each wheel as shown in the illustration.

[Cal. 5T32B]

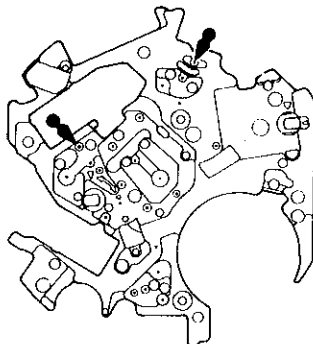

[Cal. 5T52B]

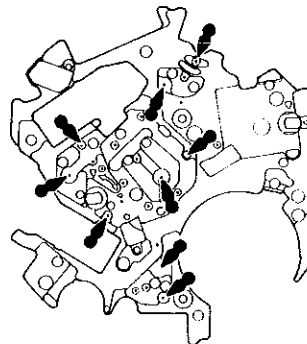

51 Setting lever spring ~ **59** Train wheel setting lever

67 Switch lever A ~ **75** Train wheel setting lever

- **Setting position and lubricating**

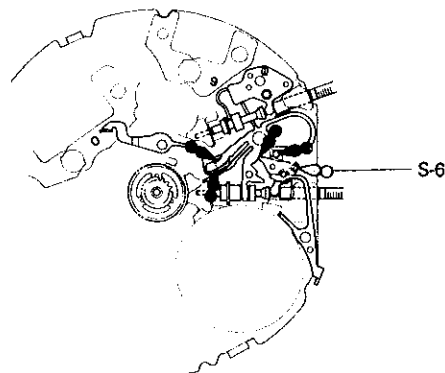

TECHNICAL GUIDE

Cal. 5T32B, 5T52B

64 **80** Center wheel and pinion

• **Lubricating**

Lubricate the center wheel and pinion as shown in the illustration.

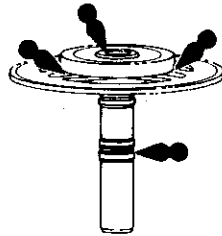

Moebius A

66 Main plate

• **Lubricating**

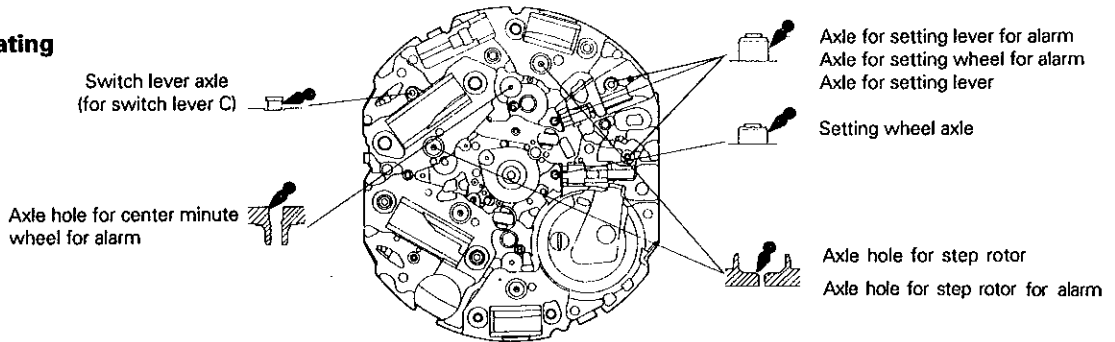

84 Main plate

• **Lubricating**

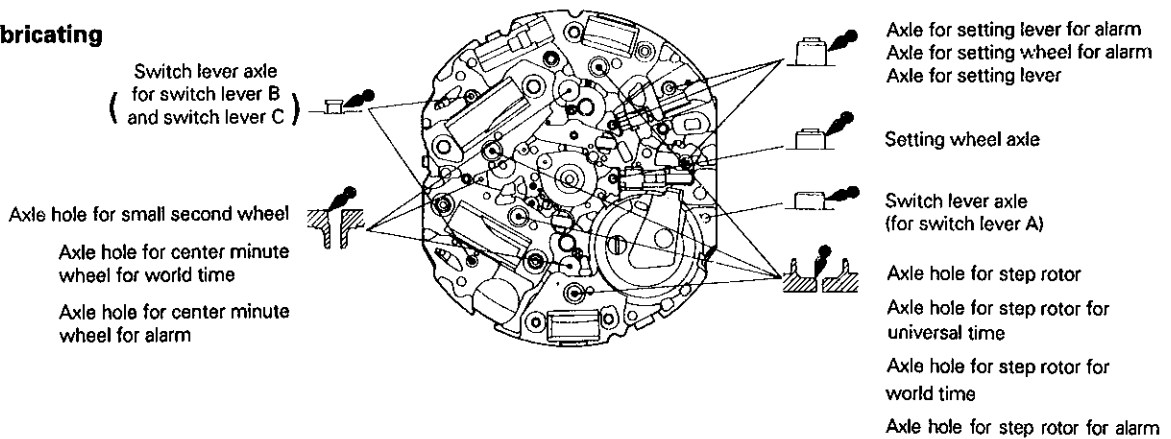

③④ ④① Train wheel bridge

• **Remarks on installing**

- Before installing the train wheel bridge, check if the wheels are set in the proper position, referring to the photograph below. Also, check their lower pivots are securely set in the axle holes.

[Cal. 5T32B]

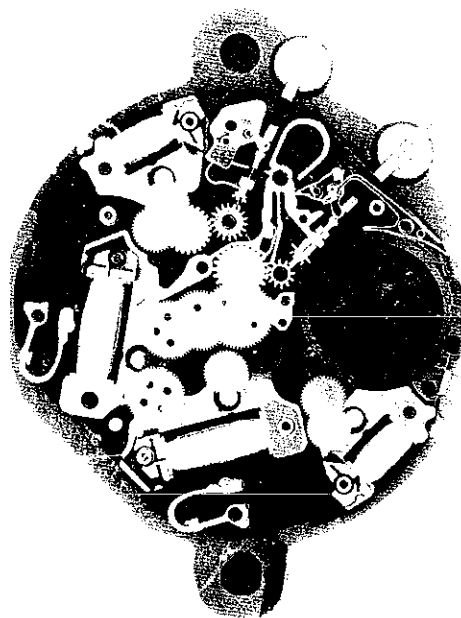

[Cal. 5T52B]

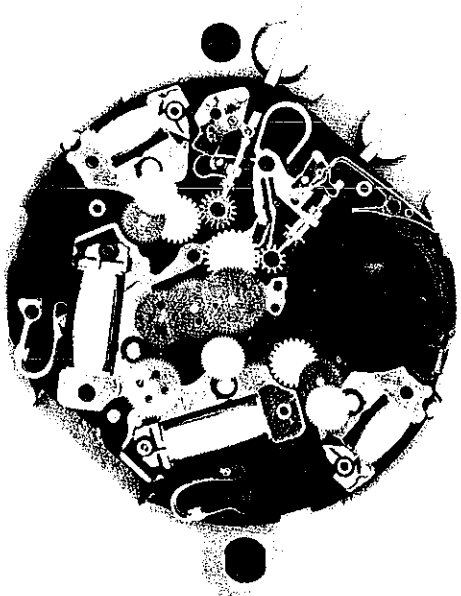

TECHNICAL GUIDE

Cal. 5T32B

③⑤ Second wheel ~ ④⑧ Setting wheel for alarm

After disassembling the wheels and rotors, arrange them as indicated in the illustration below to facilitate the reassembling procedures. However, the rotors should be kept separately from each other, as they emit magnetism.

• **Setting position**

See the illustration below.

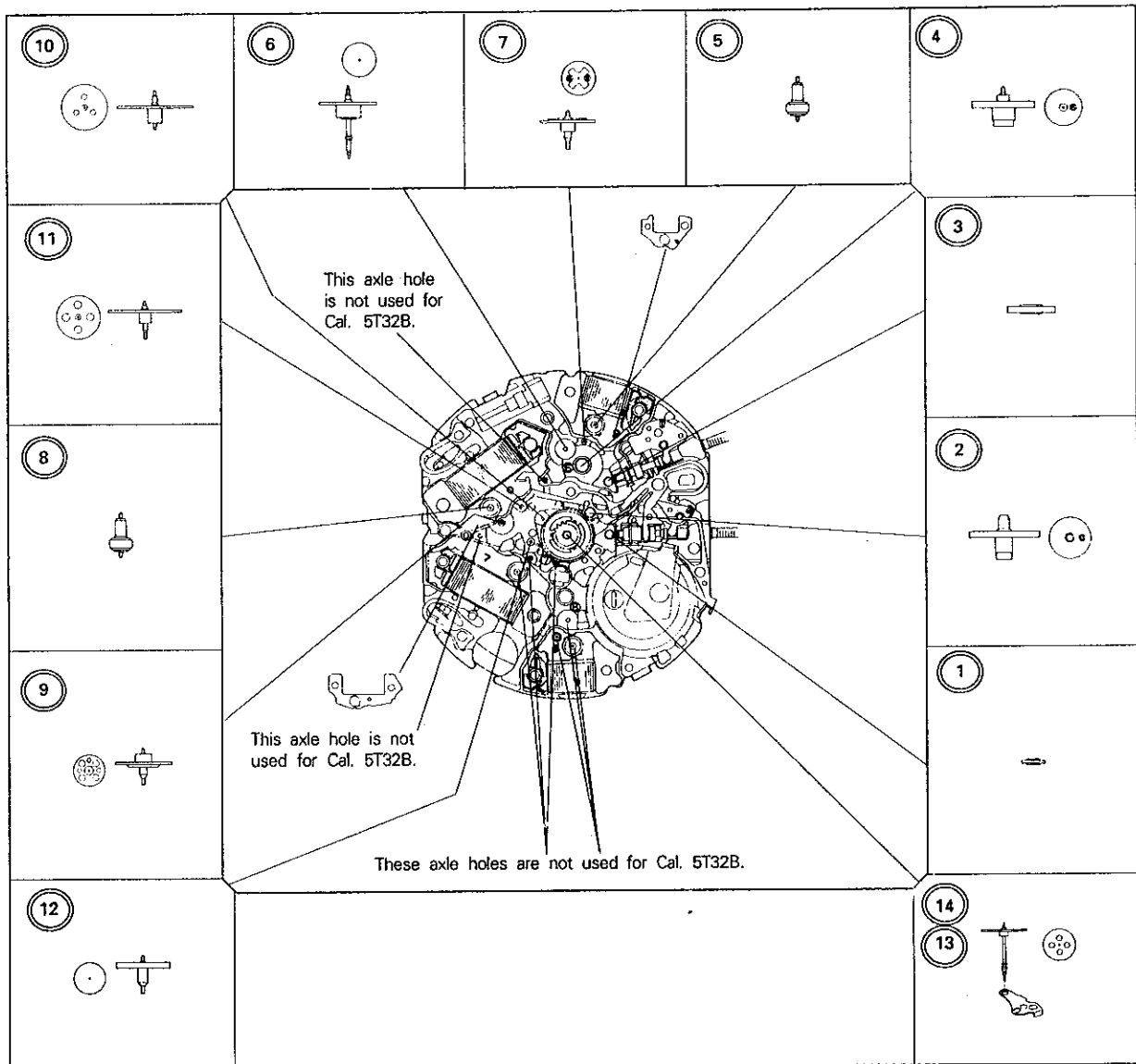

Reassembling Procedures Figs. : ① ~ ⑭

[Reassembling procedures]

- Reassemble the parts below in the following order.

* The reassembling order shown below is different from the one in the exploded view on pages 3 and 4.

- ① 281 580
Setting wheel (Metal: silver)
- ② 261 580
Minute wheel (Plastic: white)
- ③ 281 582
Setting wheel for alarm (Metal: silver)
- ④ 261 582
Minute wheel for alarm (Plastic: white)
- ⑤ 4146 710
Alarm rotor (Plastic: white)
- ⑥ 270 580
Center minute wheel for alarm (Metal: gold)
- ⑦ 950 590
Intermediate alarm wheel (Plastic: white)
- ⑧ 4146 710
Step rotor (Plastic: white)
- ⑨ 701 580
Fifth wheel and pinion (Plastic: green)
- ⑩ 231 580
Third wheel and pinion (Metal: gold)
- ⑪ 241 583
Fourth wheel and pinion (Metal: gold)
- ⑫ 817 580
Intermediate second wheel (Plastic: white)
- ⑬ 4283 581
Spacer for center wheel and pinion (Metal: silver)
- ⑭ 240 583, 240 585
Second wheel (Metal: gold)

Notes:

1. The part code of the second wheel differs depending on the installing height of hands.

Installing height of hands	Part code
Short type :	240 583
Standard type :	240 585

2. The numerals inscribed on the main plate, rotor stator and plastic wheels and pinions indicate the block No.

TECHNICAL GUIDE

Cal. 5T52B

42 Indicator wheel and pinion for universal time

62 Step rotor for world time

After disassembling the wheels and rotors, arrange them as indicated in the illustration below to facilitate the reassembling procedures. However, the rotors should be kept separately from each other, as they emit magnetism.

• **Setting position**

See the illustration below.

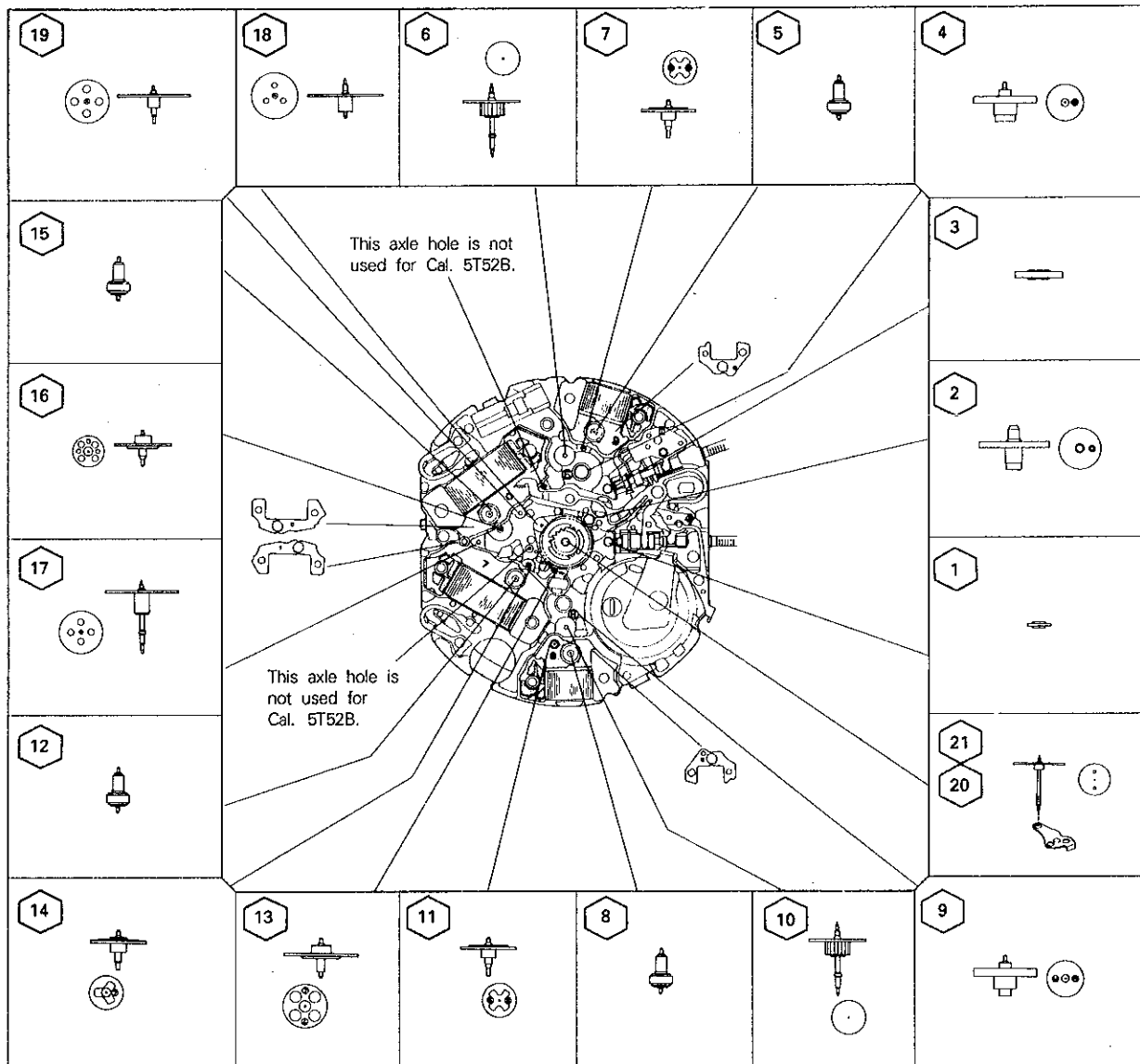

Reassembling Procedures Figs. : **1** ~ **21**

[Reassembling procedures]

- Reassemble the parts below in the following order.

* The reassembling order shown below is different from the one in the exploded view on pages 6 and 7.

- | | |
|---|--|
| <p>1 281 580
Setting wheel (Metal: silver)</p> <p>2 261 580
Minute wheel (Plastic: white)</p> <p>3 281 582
Setting wheel for alarm (Metal: silver)</p> <p>4 261 582
Minute wheel for alarm (Plastic: white)</p> <p>5 4146 710
Alarm rotor (Plastic: white)</p> <p>6 270 580
Center minute wheel for alarm (Metal: gold)</p> <p>7 950 590
Intermediate alarm wheel (Plastic: white)</p> <p>8 4146 710
Step rotor for world time (Plastic: white)</p> <p>9 264 580
Minute wheel for world time (Plastic: white)</p> <p>10 270 580
Center minute wheel for world time (Metal: gold)</p> <p>11 950 590
Intermediate wheel for world time (Plastic: white)</p> | <p>12 4146 710
Step rotor for universal time (Plastic: white)</p> <p>13 885 591
Second intermediate wheel for universal time (Plastic: green)</p> <p>14 885 590
First intermediate wheel for universal time (Plastic: white)</p> <p>15 4146 710
Step rotor (Plastic: white)</p> <p>16 701 580
Fifth wheel and pinion (Plastic: green)</p> <p>17 240 580
Small second wheel (Metal: gold)</p> <p>18 231 580
Third wheel and pinion (Metal: gold)</p> <p>19 241 583
Fourth wheel and pinion (Metal: gold)</p> <p>20 4283 581
Spacer for center wheel and pinion (Metal: silver)</p> <p>21 888 580, 888 582
Indicator wheel and pinion for universal time (Metal: gold)</p> |
|---|--|

Notes:

1. The part code of the indicator wheel and pinion for universal time differs depending on the installing height of hands.

Installing height of hands	Part code
Short type :	888 580
Standard type :	888 582

2. The intermediate alarm wheel and the intermediate wheel for world time can be used interchangeably.
3. The center minute wheel for alarm and the center minute wheel for world time can be used interchangeably.
4. The numerals inscribed on the main plate, rotor stator and plastic wheels and pinions indicate the block No.

III. VALUE CHECKING

- **Coil block resistance**

Coil block for alarm	:	1.8K Ω ~ 2.4K Ω
Coil block for world time (only for Cal. 5T52B)	:	1.8K Ω ~ 2.4K Ω
Coil block for universal time	:	1.7K Ω ~ 2.3K Ω
(only for Cal. 5T52B)		
Coil block	:	1.7K Ω ~ 2.3K Ω

- **Upconverter coil resistance:** 45 Ω ~ 60 Ω

- **Current consumption**

Before measuring current consumption, be sure to reset the circuit.

* Refer to "A necessary step after installing the battery" on page 12.

For the whole of the movement

Main time mode	:	less than 2.5 μ A
Main time mode + world time mode + alarm mode (Cal. 5T52B)	:	less than 9.0 μ A
Main time mode + alarm mode (Cal. 5T32B)	:	less than 9.0 μ A

For the circuit block alone

Main time mode	:	less than 1.8 μ A
----------------	---	-----------------------

- **Time accuracy**

When measuring the accuracy, make sure that the crown for main time setting (at the 3 o'clock side) and the crown for alarm (at the 4 o'clock side) are at the first and second click positions, respectively.

* Main time and world time settings are impossible when the crowns are at the above positions.

IV. CHECKING OF THE FUNCTIONS

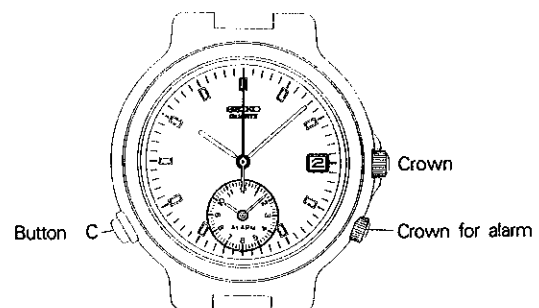
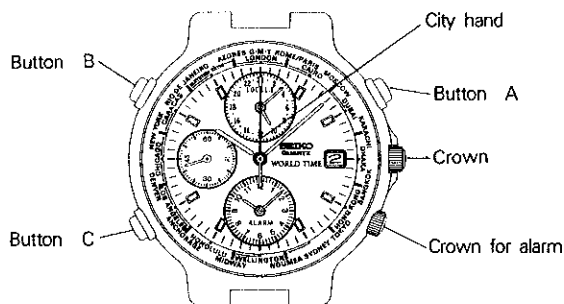

- **Checking of the regular alarm function**

- 1) Pull out the crown for alarm all the way to the second click and check if the warning sound beeps for one second. (The warning sound indicates that the designated alarm time has been canceled.)
- 2) Push the crown for alarm in to the first click from the second click, and check if the chime rings for approximately one minute.

- 3) Pull out the crown for alarm all the way to the second click to check the time indicated by the alarm hands, and then push it in to the first click. By doing so, the chime rings. Press button "C" to stop it.
 - 4) Press button "C" again to advance the alarm hands one minute ahead of the time you have checked.
 - 5) Check if the alarm rings after one minute for 20 seconds and stops.
- * The regular alarm is engaged when the crown for alarm is at the first click position. The crown at the 3 o'clock side has nothing to do with engagement/disengagement of the alarm.

• Checking of the single-time alarm function

- 1) Press button "C" once with the crown at the 3 and 4 o'clock sides at the normal position to advance the alarm hands one minute.
 - 2) Check if the beeping sound rings after one minute and stops.
- * The crown at the 3 o'clock side has nothing to do with engagement/disengagement of the alarm.
* When the crown at the 4 o'clock side is at the first click, the regular alarm is engaged and the single-time alarm cannot be used.

The following checking procedures should be carried out for Cal. 5T52B.

• Adjustment of the city hand

- 1) Pull out the crown at the 3 o'clock side all the way to the second click.
- 2) Press button "A" or "B" to adjust the city hand to the center of a city marker.
* The hand turns clockwise by pressing button "A" and counterclockwise by pressing button "B".

• Main time and world time setting

- 1) After adjusting the city hand, pull out the crown at the 3 o'clock side to the second click and turn it to set the main time to the current time of your local area.
* Check that AM/PM is properly set. If the date changes, the watch is set for the AM period.
- 2) Push the crown back in to the normal position.
- 3) Press button "A" or "B" to set the city hand to the current time of your local area.
* The hand turns clockwise by pressing button "A" and counterclockwise by pressing button "B".
- 4) Pull out the crown at the 3 o'clock side to the first click (calendar setting position) and press button "A" or "B" to set the small hands of the world time display (at the 12 o'clock position) to the main time.
* World time is displayed in the 24-hour indication.
* The hands turn clockwise by pressing button "A" and counterclockwise by pressing button "B".
- 5) Push the crown back in to the normal position. The hands of the world time display starts moving.
Note: The main time and world time hands are not interlocked with each other.

- **Checking of the world time function**

- 1) Press button "A" or "B" with the crown at the 3 o'clock side at the normal position to set the city hand to a desired city and check if the small hands of the world time display at the 12 o'clock position turn to indicate the time of the corresponding city.

* Time differential between two cities marked side by side on the bezel is one hour.