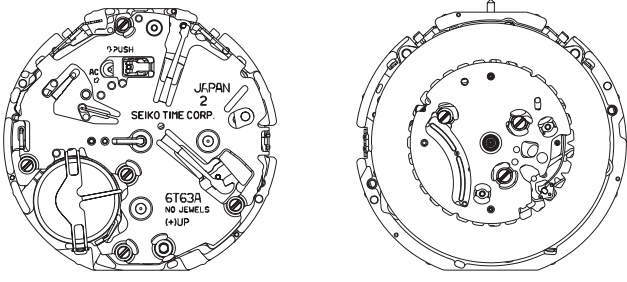

# PARTS CATALOGUE/TECHNICAL GUIDE

## Cal. 6T63A

### [SPECIFICATIONS]

Item		Cal. No.	6T63A
			
<ul style="list-style-type: none"> <li>• 3 hands (hour, minute, and small second hand)</li> <li>• 24-hour indicator</li> <li>• Date indicator</li> </ul>		<ul style="list-style-type: none"> <li>• Diameter Outside: Ø 30.8 mm</li> <li>• Height: 5.1 mm</li> </ul>	Casing: Ø 29.0 mm
Interval of hands movement		1 second	
Driving system		Stepping motor, 2 pieces	
Additional function		<ul style="list-style-type: none"> <li>• Stopwatch function 60-minute stopwatch in one second increments.</li> <li>• Second hand stop function</li> </ul>	
Crown operation	Normal position	Free	
	1st click position	Date setting (clockwise)	
	2nd click position	Time setting, hand position adjustment / resetting the circuit	
Loss/gain		Monthly rate: Less than 20 seconds (worn on the wrist at the temperature between 5 and 35)	
Regulation system		Nil	
Gate time for rate measurement		Use 10-second gate.	
Current consumption		Movement: Less than 2.70 µA Circuit block: Less than 0.70 µA	
Coil resistance		4002054 (COIL BLOCK A) 1.45 - 1.65 KΩ ..... 4002055 (COIL BLOCK B) 1.65 - 1.85 KΩ	
Power supply	Battery No.	SEIKO SR936SW	
	Battery voltage	1.55 V	
	Battery life	Approx. 3 years	
Number of jewels		0 jewel	

SEIKO WATCH CORPORATION

Cal. 6T63A has a new structure employing one crown and two buttons. The construction of chronograph mechanism is based on Cal. 8R28 mechanical chronograph watch by using the one-piece 3 pointed reset hammer. While other Swiss-made watches are using separate hammers which require an assembly and adjustment of the hammers, the one-piece hammer design realizes maximum durability and stability of the component and easier maintenance. It is also equipped with the self-alignment function for all counting hands to return to zero positions instantaneously.

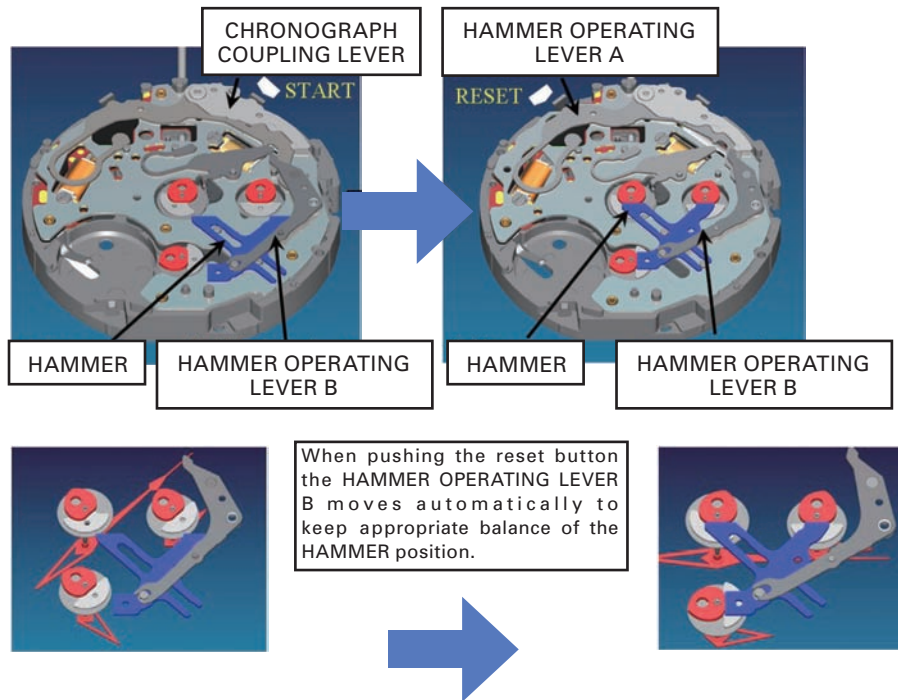

## FEATURES

### Cal. 6T63A

This is the multi-display analogue watch featuring a stopwatch function.

- The time is indicated by the 24-hour, hour and minute hands, and a small second hand.
- The stop watch can measure up to 60 minutes in one second increments. After 60 minutes, it will stop automatically.

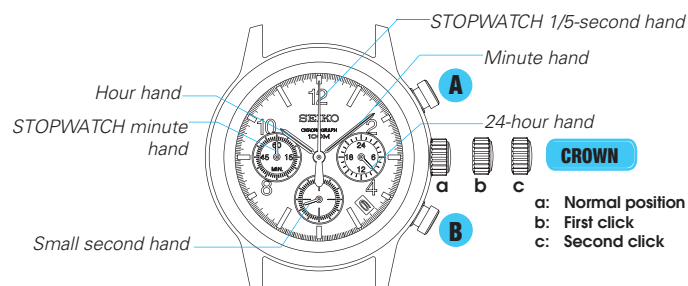

### 1. STOPWATCH FUNCTION

- **Measurement performance**  
Displays the elapsed time with the 2 designated STOPWATCH hands.  
Measures up to 60 minutes in one second increments.
- **Button operation (Crown position: Normal position)**  
Button A: START/STOP

## ● Measurement functions

Accumulated elapsed time measurement and split time measurement are available.

- Standard measurement



- A ccumulated elapsed time measurement

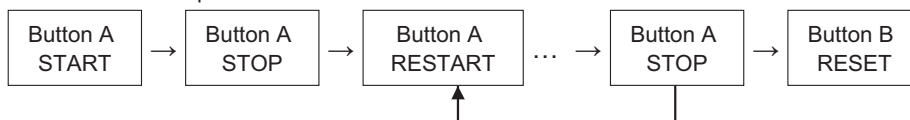

Restart and stop of the stopwatch can be repeated by pressing button A.





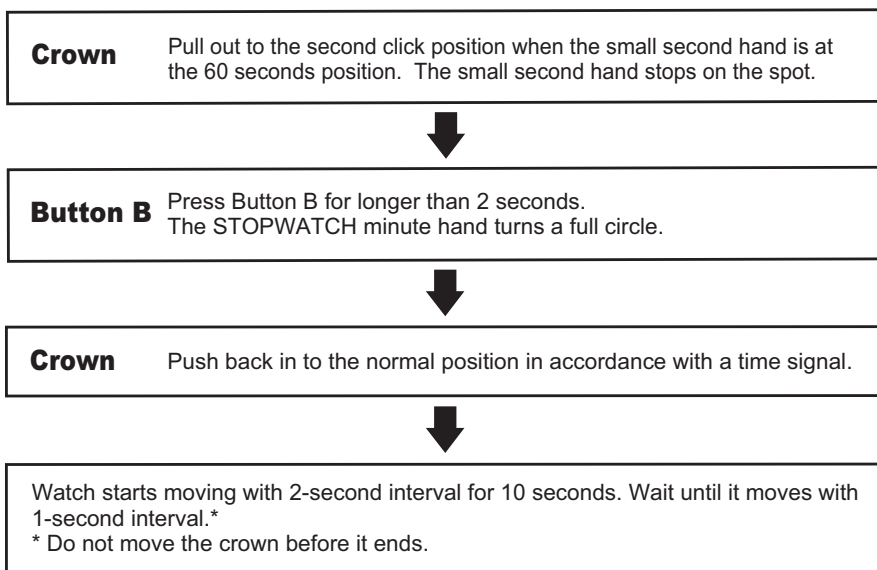

## NECESSARY PROCEDURE AFTER BATTERY CHANGE

After installing the battery, pull out the crown to the second click position. And then follow the instructions below to correct the hand positions and set the time.



# PARTS LIST

Cal. 6T63A

		Type of oil	Oil quantity mark
Disassembling procedures Figs. :	① → ⑥1	 AO-3	 SMALL QUANTITY
Reassembling procedures Figs. :	⑥1 → ①	 AO-2	 NORMAL QUANTITY
		 S-6	 LIBERAL QUANTITY

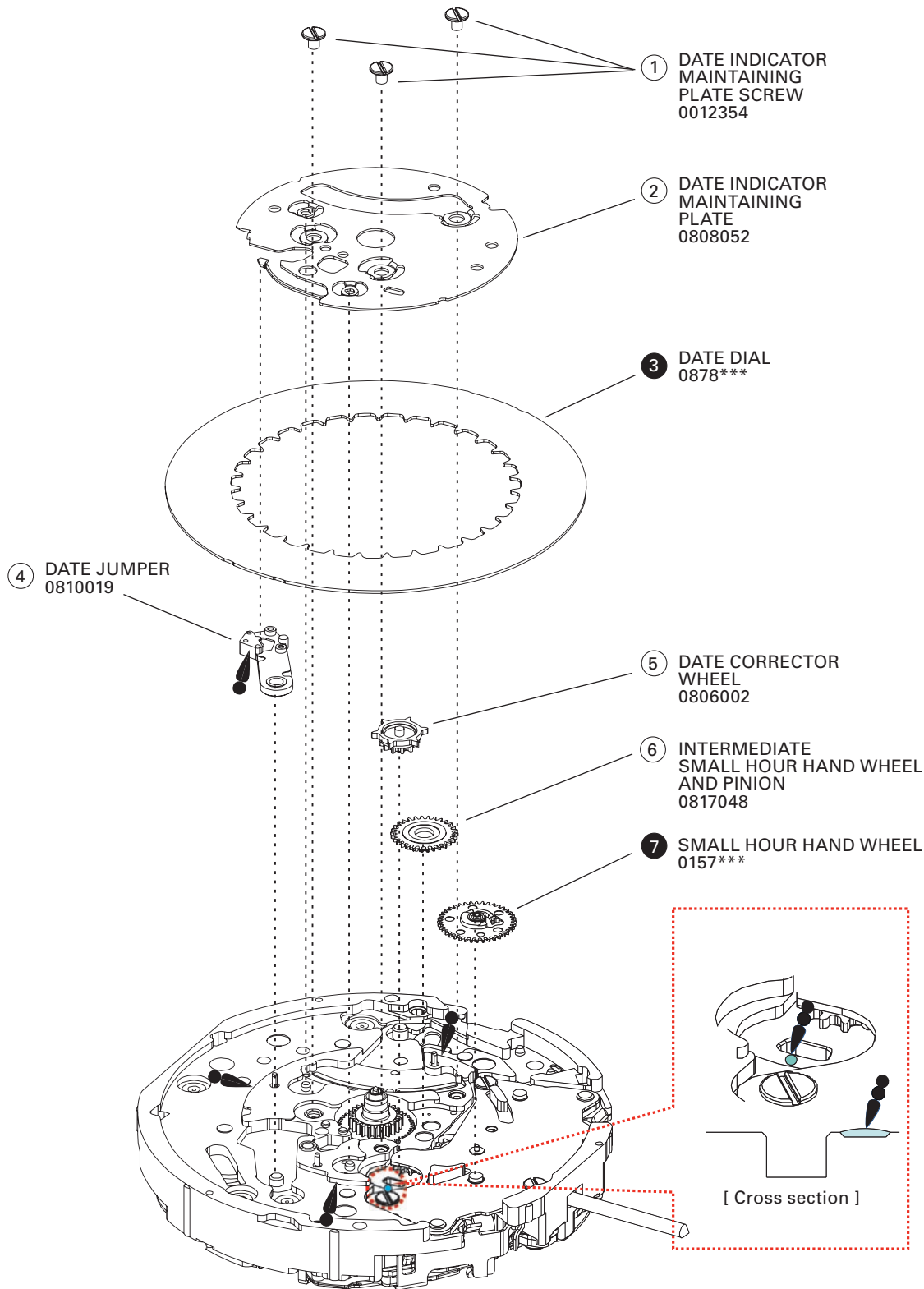

For parts ③ and ⑦, please refer to the page 10.

# PARTS LIST

Cal. 6T63A

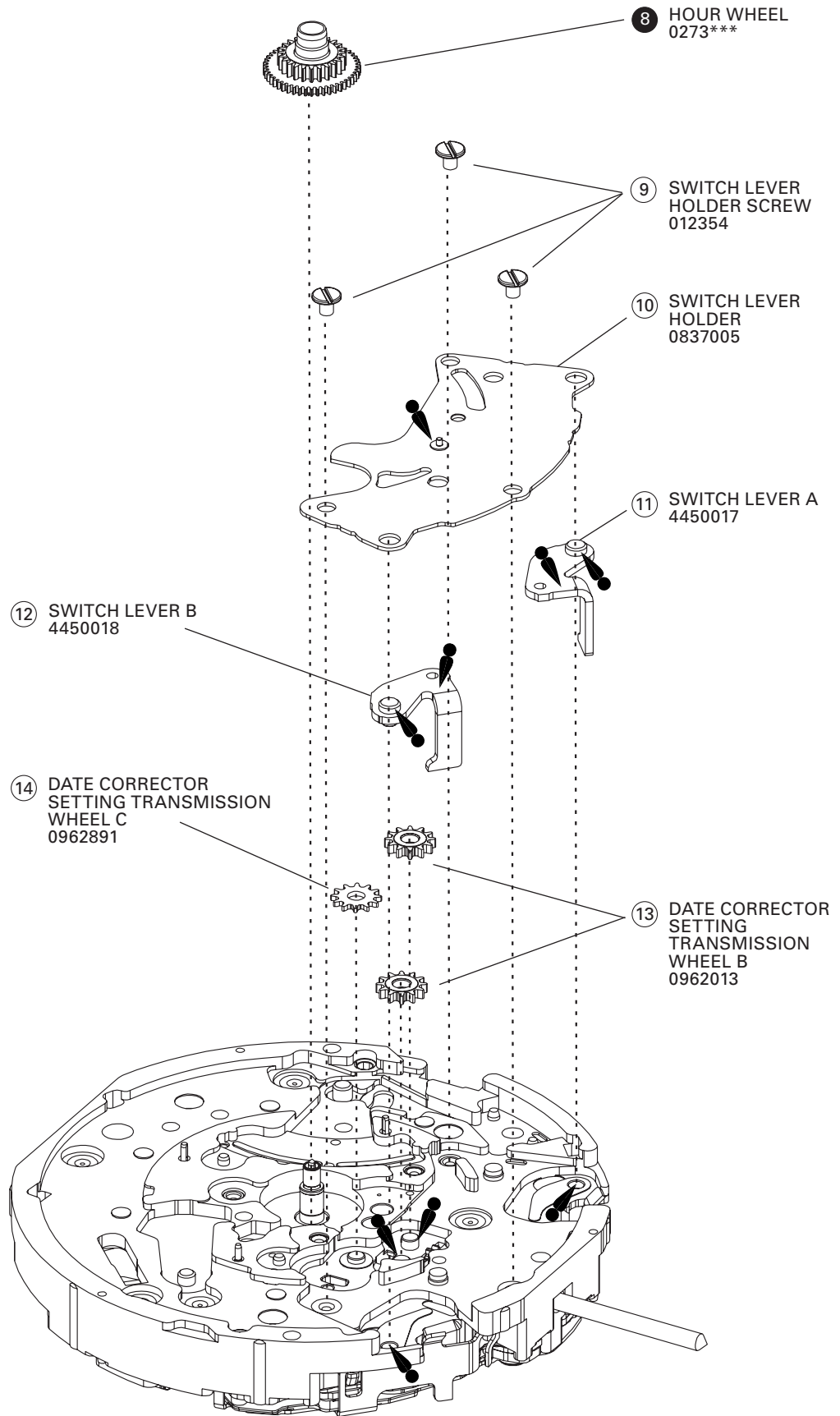

For parts 8, please refer to the page 10.

# PARTS LIST

Cal. 6T63A

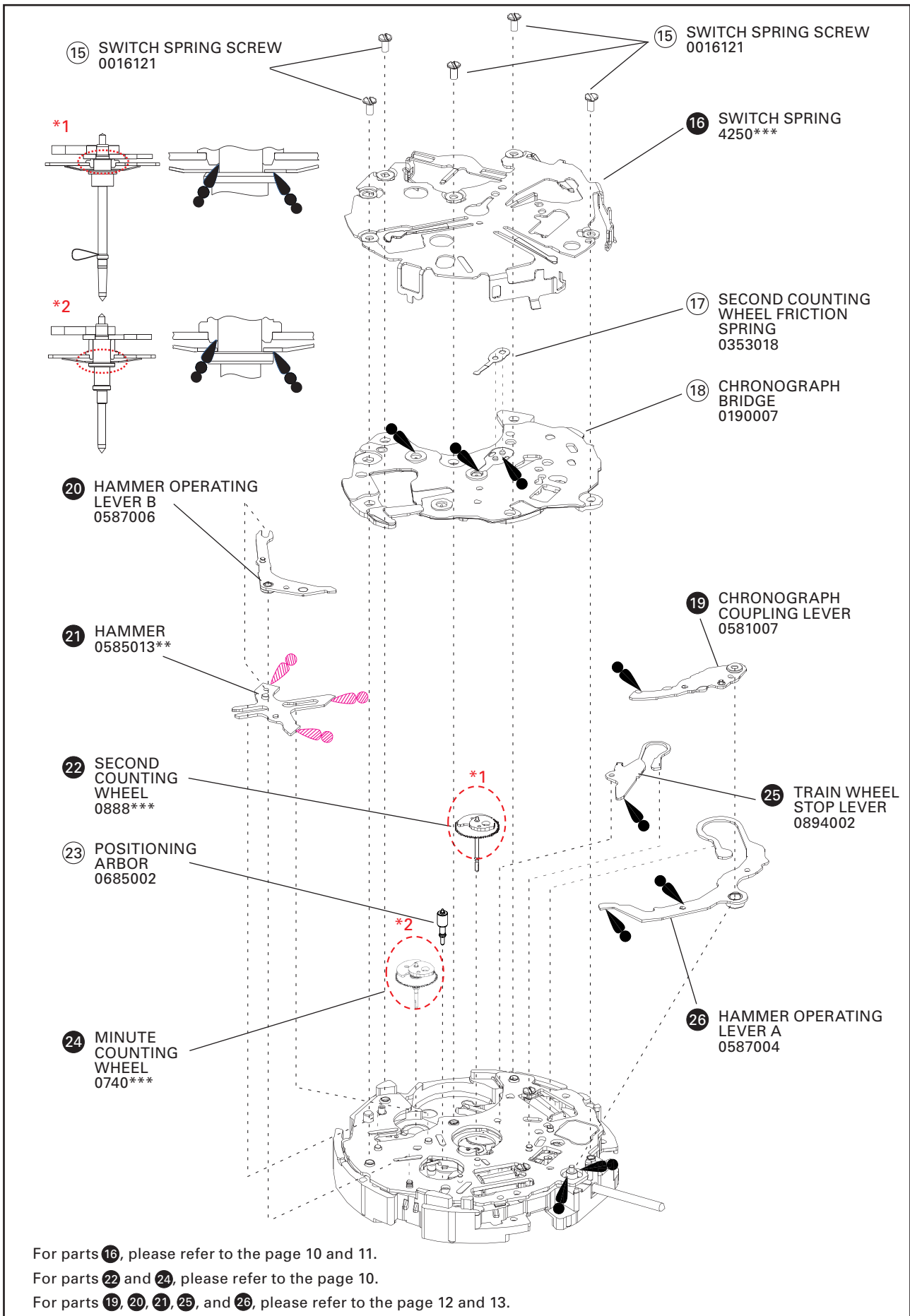

# PARTS LIST

Cal. 6T63A

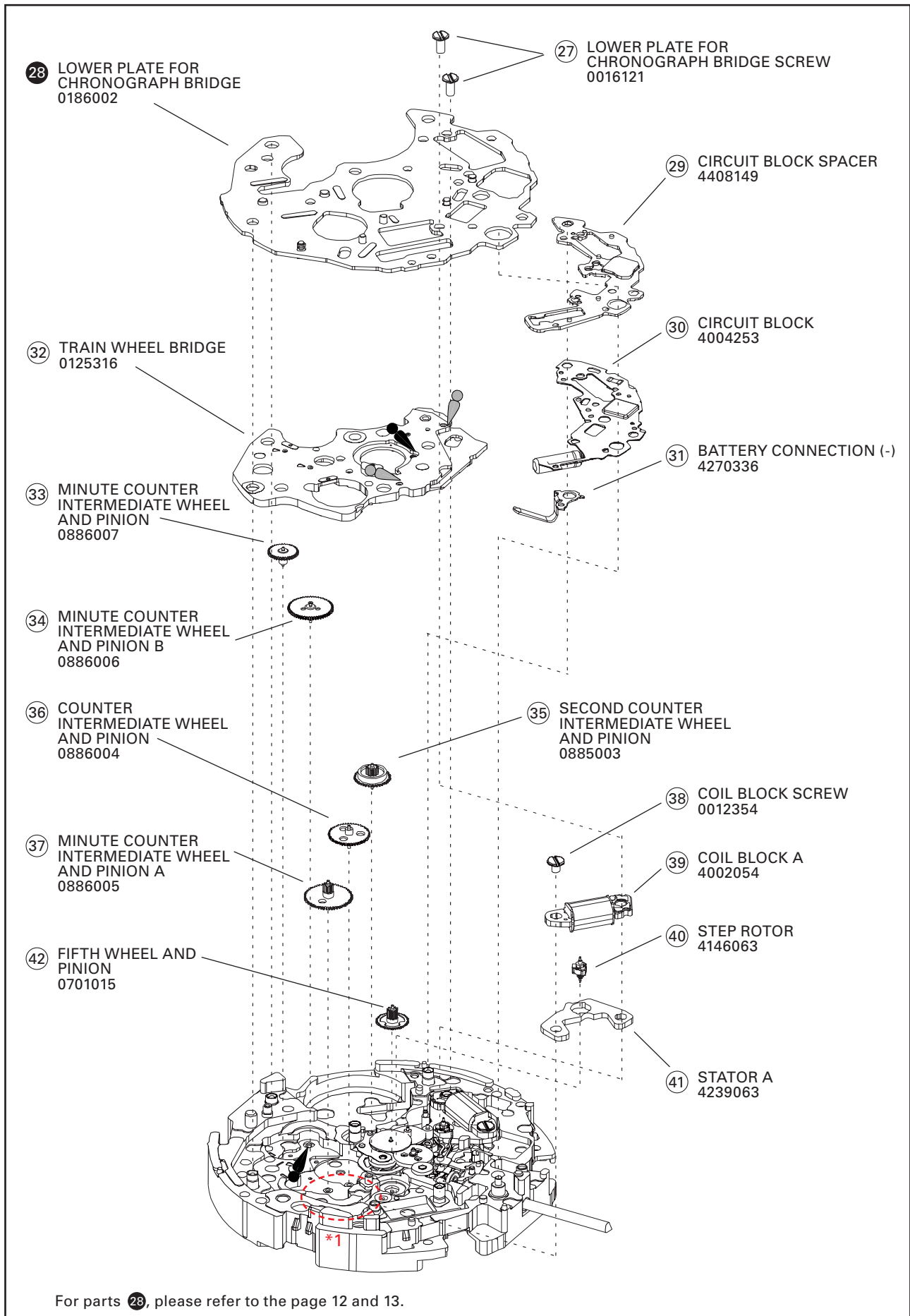



# PARTS LIST

Cal. 6T63A

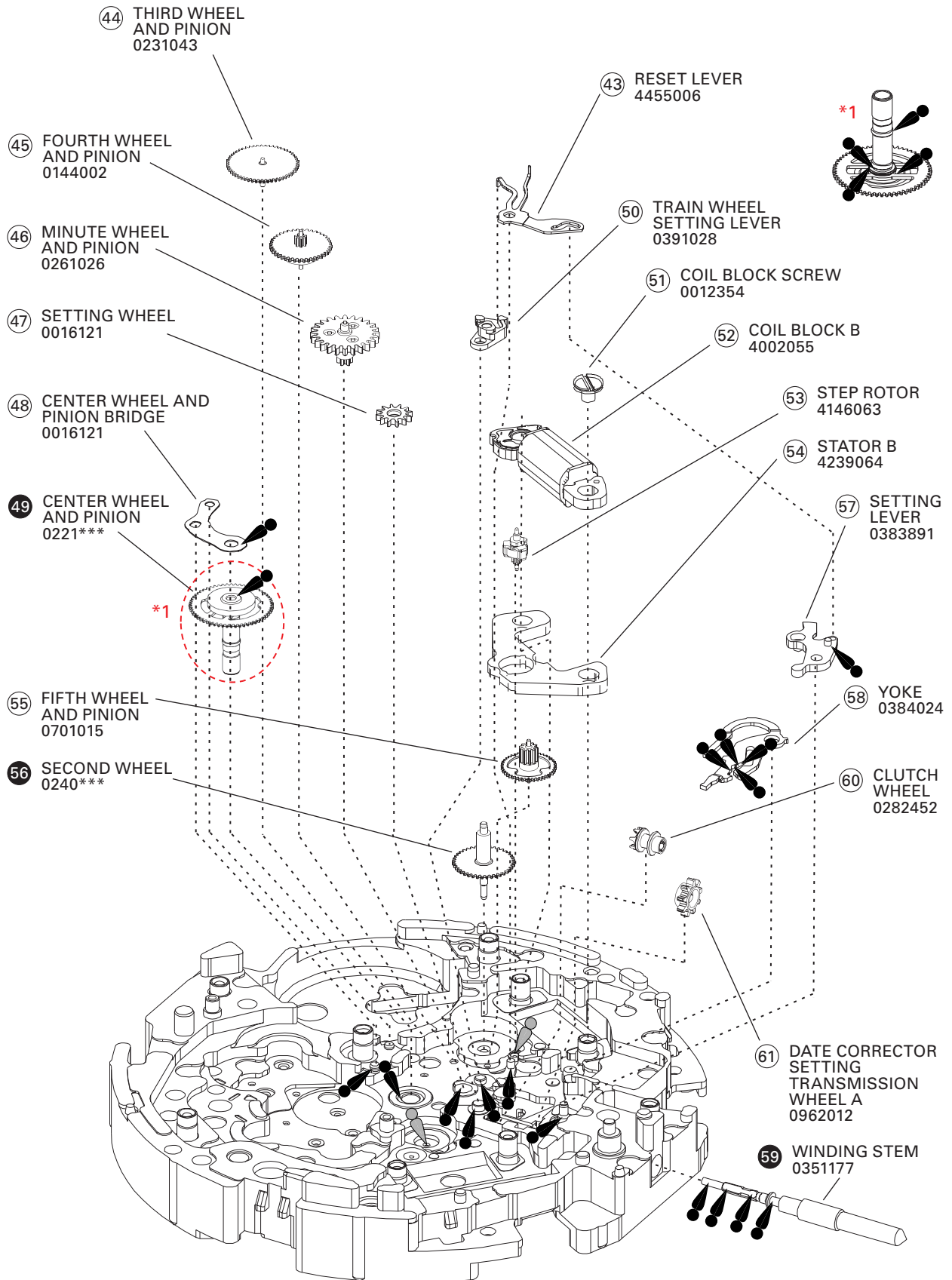

For parts 49, 56 and 59, please refer to the page 10.



● **Tools and consumables required for disassembling/reassembling**

• **Movement holder**

UNIVERSAL MOVEMENT HOLDER (S-682)

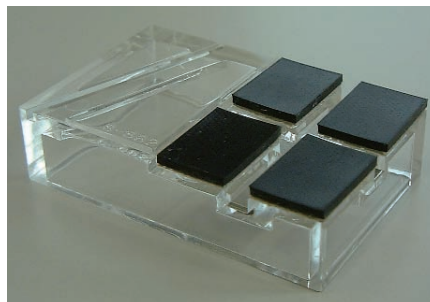

• **Watch oils**

SEIKO watch oil AO-3 (or Moebius A) and AO-2 (or Moebius F)

AO-3



S-6



AO-2



● **How to find the correct parts, if not determined by 4 digit caliber number**

Following parts are determined based on the design of watches, such as hands height, dial color, and design of cases. Please refer to the SEIKO WATCH PARTS CATALOGUE in order to choose corresponding parts.

③ DATE DIAL                    0878\*\*\*

⑤9 WINDING STEM            0351177

\* For screw down crown models, the stem is assembled to the crown and is not available separately

⑦ SMALL HOUR HAND WHEEL

⑧ HOUR WHEEL

①6 SWITHCH SPRING

②2 SECOND COUNTING WHEEL

②4 MINUTE COUNTING WHEEL

④9 CENTER WHEEL AND PINION

⑤6 SECOND WHEEL

Please refer to the following table in order to find the correct part number of each wheel according to the hand installation height. The numeral 2 or 4 is printed on the DIAL.

	⑦ SMALL HOUR HAND WHEEL	⑧ HOUR WHEEL	①6 SWITHCH SPRING	②2 SECOND COUNTING WHEEL	②4 MINUTE COUNTING WHEEL	④9 CENTER WHEEL AND PINION	⑤6 SECOND WHEEL
2	0157012	0273038	4250035	0888017	0740002	0221087	0240018
4	0157013	0273042	4250054	0888019	0740003	0221092	0240019

## REMARKS ON DISASSEMBLING AND REASSEMBLING THE MOVEMENT

### ● How to remove the SETTING STEM before dismantling the movement

Crown position: normal (=0) position.

Push the "A" on the SETTING LEVER gently (refer to the picture on the right) in order to disengage it from the SETTING STEM. Then pull out the crown with the stem completely. FOR UNIT'S DIGIT properly.

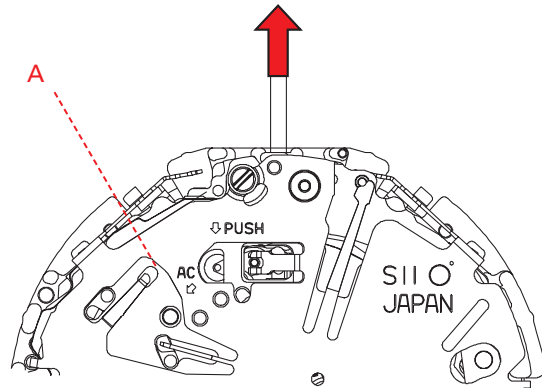

### ● How to remove or install the battery

- 1) Remove the hook of the switch spring's battery clamp.
- 2) Insert the battery sideways, and have the hook of the switch spring's battery clamp catch the main plate.

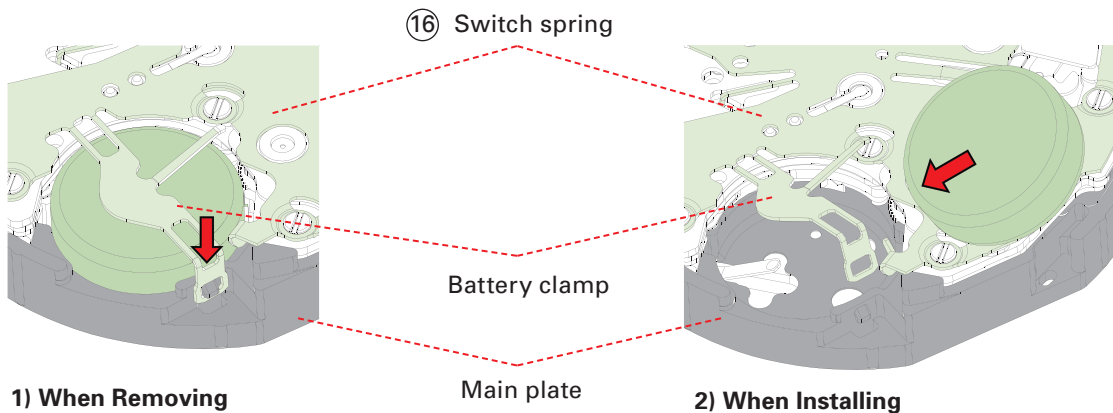

### ● Remarks on installing the battery

- 1) After the battery is replaced battery is reinstalled following the repairing procedures, be sure to touch the AC terminal of circuit block and the switch spring with conductive tweezers to reset the circuit as illustrated.

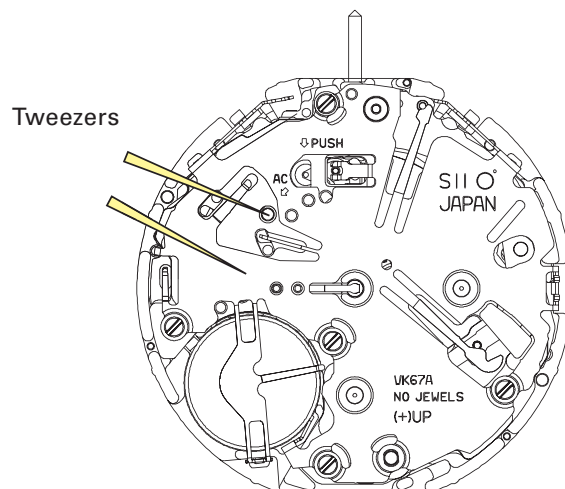

● **Remarks for the lubrication**

⑳ Hammer

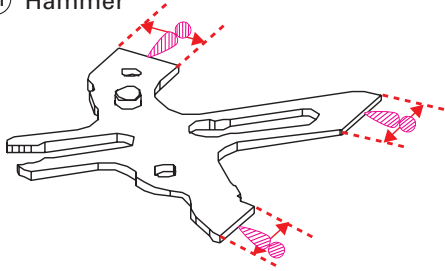

Type of oil		Oil quantity mark	
	AO-3		SMALL QUANTITY
	AO-2		NORMAL QUANTITY
	S-6		LIBERAL QUANTITY

There must be oil within the range of the arrow.

㉘ Lower plate for chronograph bridge

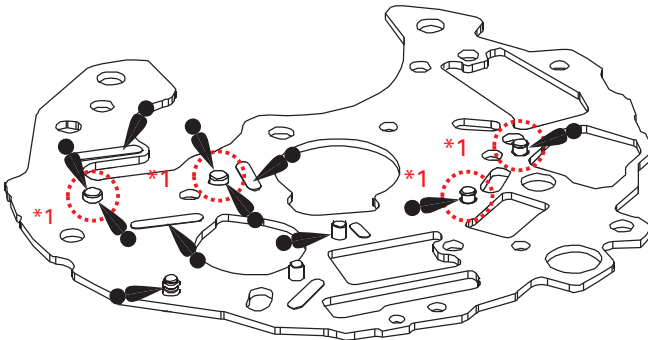

**Note**

**\*1:** Oiling should be done on the pointed spot of marked place.

⑯ Switch spring

\*Oiling spot and spring setting position.

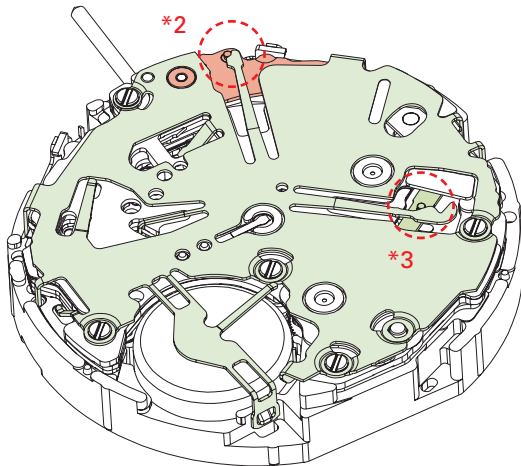

⑲ Chronograph coupling lever

Setting position

㉚ Hammer operating lever B

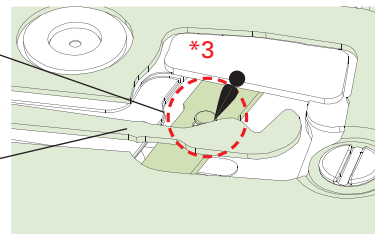
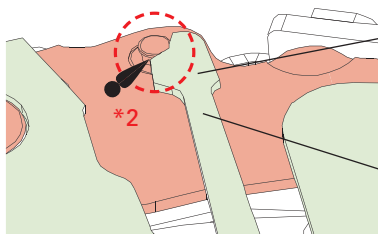

⑯ Switch spring

**\*Oiling should be done on the contact spot of the spring and the pin.**

● **Remarks for setting position of the spring of chronograph function**

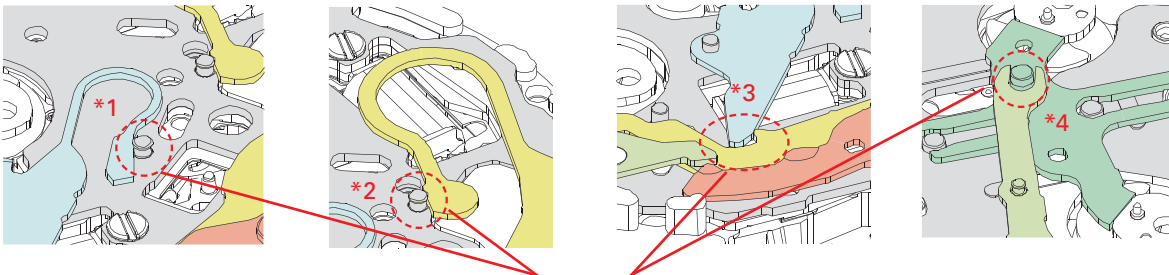
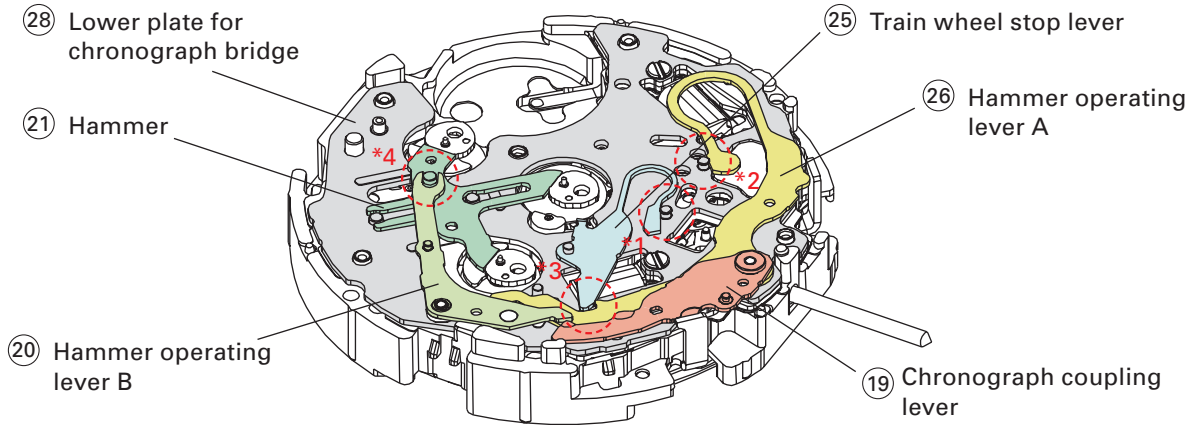

Setting position

● **Remarks for setting position of the SWITCH LEVER A and B**

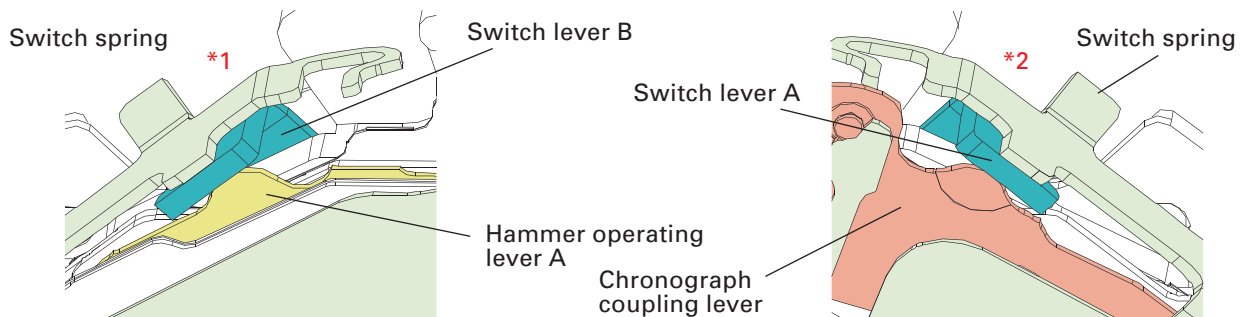
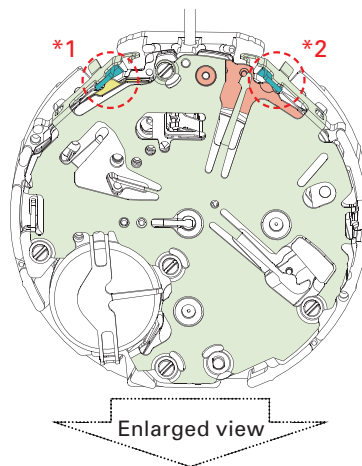

Switch lever B is set between the switch spring and hammer operating lever A .

Switch lever A is set between the switch spring and chronograph coupling lever.

## REMARKS ON INSPECTION AND MEASUREMENT

### ● How to measure the current consumption for the whole movement

1. To measure the current consumption for the whole movement, connect the (-) probe to the battery connection (-) and (+) probe to the other metal part of the movement, such as battery clamp or circuit block cover.
- \* When measuring the current consumption using the SEIKO digital multi-tester (S-860), use the range of 40  $\mu$  A of SUPPLY V (= 1.55 V) & GATE TIME (2 S).
2. Connect the AC component to the positive terminal for 2 seconds until a short circuit occurs to reset the integrated circuit.
3. After the integrated circuit is reset, wait approximately for 10 seconds until a stable measurement is obtained, and then read the measurement.
4. Make sure the read value is less than 2.7  $\mu$  A.

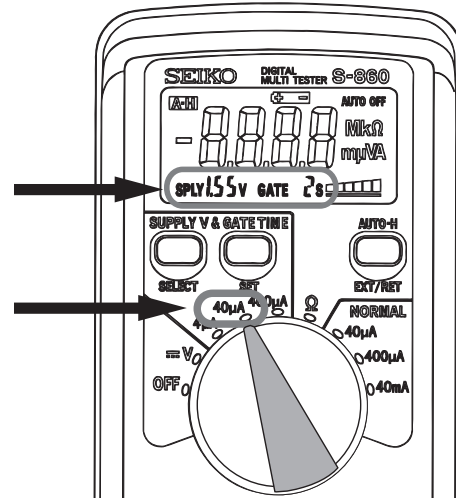

### ● How to measure the current consumption for the CIRCUIT BLOCK alone

1. To measure the current consumption for the CIRCUIT BLOCK alone, connect each probe to the appropriate positive (+) or negative (-) input terminal of the CIRCUIT BLOCK (please refer to "Structure of the CIRCUIT BLOCK" below).
- \* When measuring the current consumption using the SEIKO Multi-Tester S-860, use the range of 4  $\mu$  A of SUPPLY V (= 1.55 V) & GATE TIME (2 S).
2. Repeat the same procedures as 2. and 3. of measuring current consumption for the whole movement above.
- \* When measuring the current consumption for the circuit block alone, be careful not to damage or deform the pattern of the circuit block.
3. Make sure the read value is less than 0.7  $\mu$  A.

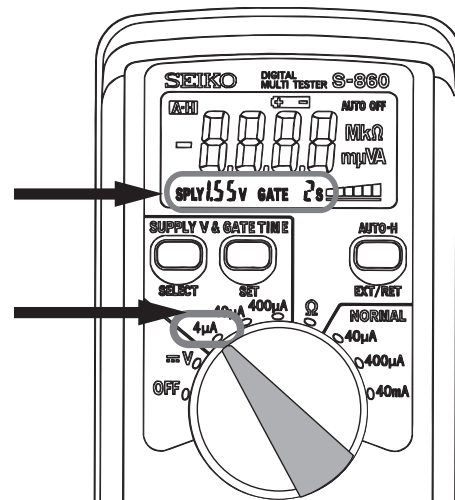

**[Structure of the CIRCUIT BLOCK]**

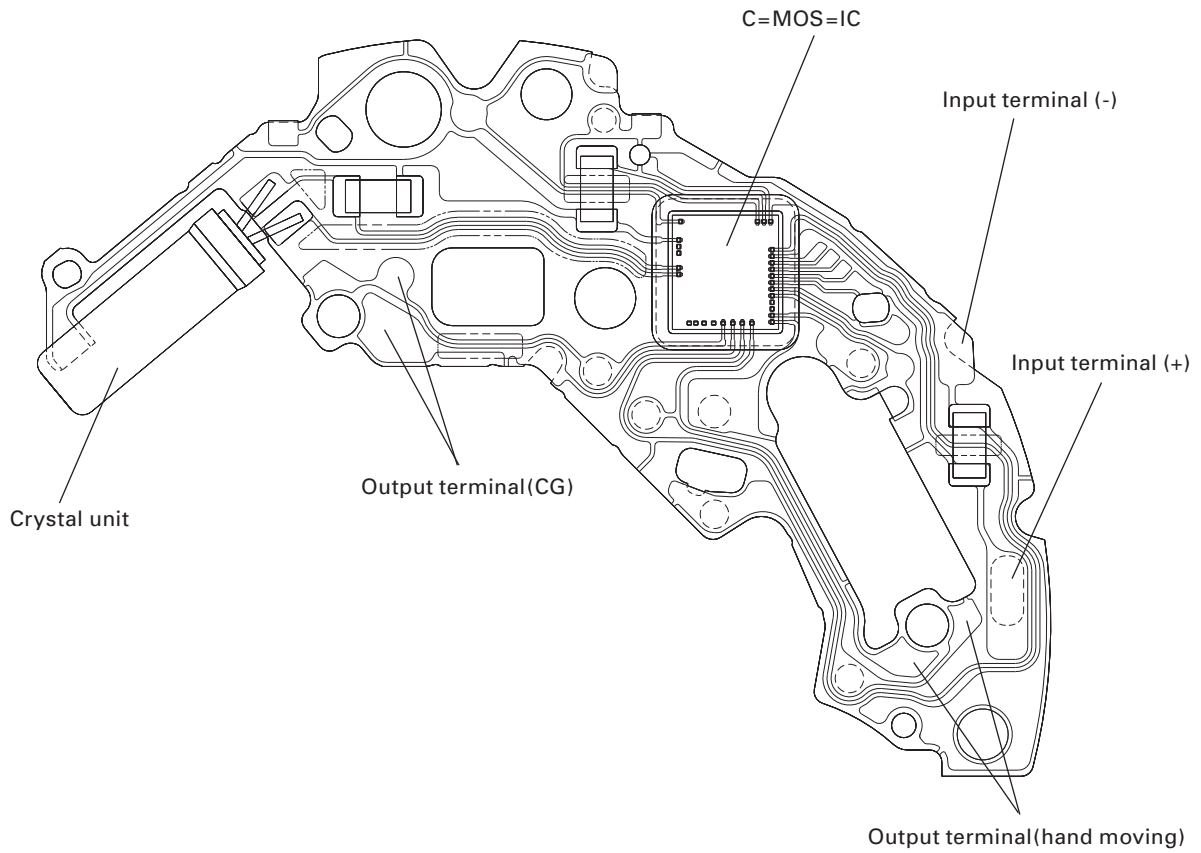

● **Value checking – coil resistance (coil blocks)**

Check the resistance of each coil block if they are within the range in the following table.

COIL BLOCK (A)	4002054	1.45 K $\Omega$ ~ 1.65 K $\Omega$
COIL BLOCK (B)	4002055	1.65 K $\Omega$ ~ 1.85 K $\Omega$



# TECHNICAL GUIDE

Cal. 6T63A

## ● Function check

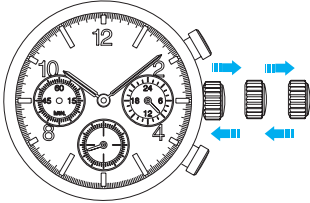
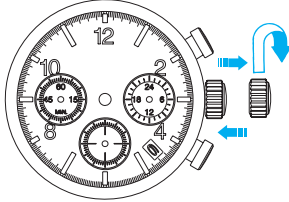
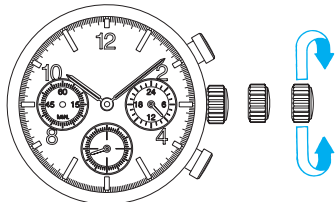
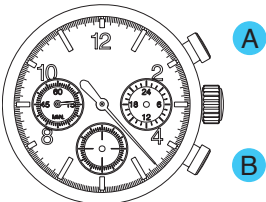
Operation	Function	Checkpoint
 <p>Pull out the crown to the 2nd click and push it back in to the normal position. Repeat the same several times.</p>	<p>Setting mechanism - switching the function of the time setting</p>	<p>Make sure that it has a click at each position and the stem is not pulled off.</p>
 <p>Pull out the crown to the 1st click, then turn it clockwise.</p>	<p>Calendar mechanism - correcting the day</p>	<p>Make sure that the day changes smoothly.</p>
 <p>Pull out the crown to the 2nd click, then turn it.</p>	<p>Setting mechanism - hour and minute hand setting</p>	<p>Make sure that the hour and minute hands move smoothly (without touching each other or touching the surface of the dial or inside of the glass).</p>
	<p>Hands installation</p>	
	<p>Calendar mechanism - date change</p>	<p>Make sure that the date changes when the hour and minute hands pass around midnight.</p>
 <p>Press button A to start the stopwatch.</p> <p>Press button A again to stop the stopwatch.</p> <p>Press button B to reset the stopwatch.</p> <p>A → A → B Start Stop Reset</p>	<p>Stopwatch mechanism</p>	<p>Make sure that the Stopwatch hands start/stop smoothly.</p> <p>Make sure that the Stopwatch hands are reset to the "0" position.</p>

# TECHNICAL GUIDE

Cal. 6T63A

● **Water resistance test**

Check the water resistance according to the designated specification of the watch.

Marking on the case back	Test method	Applied pressure
WATER RESISTANT (WATER RESIST)	Air leak test	3 BAR
WATER RESIST 5BAR	Water pressure test ↓	5 BAR
WATER RESIST 10BAR		10 BAR
WATER RESIST 15BAR	Condensation test	15 BAR
WATER RESIST 20BAR		20 BAR
SCUBA DIVER'S (AIR DIVER'S) 150 m	Condensation test ↓	18.75 BAR = 150 (m) times 0.125
SCUBA DIVER'S (AIR DIVER'S) 200 m		25 BAR = 200 (m) times 0.125
He-GAS DIVER'S 300 m	Water pressure test ↓	37.5 BAR = 300 (m) times 0.125
He-GAS DIVER'S 600 m		75 BAR = 600 (m) times 0.125
He-GAS DIVER'S 1000 m	Condensation test	125 BAR = 1000 (m) times 0.125

## TROUBLESHOOTING

	Symptom	Possible causes	Solutions
Movement	The watch stops operating.	The battery has been depleted.	Measure the battery voltage. Replace the battery with a new one.
		The hour wheel and the pinion of the minute wheel are not properly engaged. (Or the teeth of the hour wheel and/or minute wheel have been broken.)	Check the relevant parts, and replace the damaged parts with new ones.
		The hooking portions of the circuit block cover are not properly engaged, resulting in poor conductivity.  The coil is broken.	Securely attach the hooks of the circuit block cover to the main plate.  Measure the coil block resistance. Replace the coil with a new one.
		One or more wheels have been contaminated with dirt, dust or other particles.  An excessive amount of oil in the movement has caused adhesive forces among the parts. (wringing)	Remove dirt or dust and clean the contaminated wheels. Be careful so as not to damage the teeth of the plastic parts while cleaning.
	The current consumption for the whole movement exceeds the standard value.	Dirt, dust or foreign particles are adhered to the movement.	Remove dirt, dust or foreign particles and clean the movement.
		The driving pulse is generated in order to compensate the excessive load applied to the wheels. (The oil has deteriorated, leaked or run out.)	If the current consumption for the circuit block alone is within the standard value range, overhaul and clean the movement parts, and then make the measurement again.
	The current consumption for the circuit block alone exceeds the standard value.	The light from outside the movement is affecting the measurement.	Shut out the light, and make the measurement again.
There is a defect in the IC (integrated circuit).		Replace the circuit block with a new one.	

# TECHNICAL GUIDE

Cal. 6T63A

	Symptom	Possible causes	Solutions
STOPWATCH	One or more STOPWATCH hands have stopped moving or show an abnormal movement.	The relevant coil is broken.	Measure the coil block resistance. Replace the coil with a new one if necessary.
		An excessive load is being applied to the chronograph wheels due to dust or foreign particles adhering to them or oil starvation.	Clean the relevant parts and lubricate with an adequate amount of oil.
	The step motor shows an abnormal movement.	There is a crack on the circuit block switch pattern.	Replace the circuit block with a new one.
		The step motor has been deformed.	Replace the stator with a new one.
	The buttons do not operate normally.	The amount of oil around the buttons is insufficient. The circuit block pattern has been broken or bent.	Clean the buttons and lubricate appropriately. Adjust the circuit block pattern or replace the circuit block with a new one.
Exterior parts	The crown falls off.	The winding stem is not securely installed. (The setting lever and yoke are disengaged.)	Check the main plate, winding stem, setting lever and yoke. Replace the defective parts with new ones.
	The current consumption exceeds the standard value.	An excessive load is being applied due to friction among the hour, minute and STOPWATCH hands.	Adjust or remount the relevant hands.
	Small amount of water/blur inside of the glass persists.	Water resistance is deteriorated. The watch has been subjected to water pressure that exceeds the guaranteed degree.	Investigate the causes to take necessary measures, while cleaning inside of the watch.