



PARTS CATALOGUE / TECHNICAL GUIDE

Cal. 7N32C

Cal. 7N33C

Cal. 7N39C

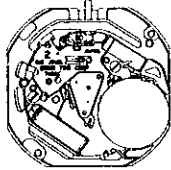
[SPECIFICATIONS]

Item		Cal. No.	7N32C	7N33C	7N39C	
Movement			 			
			The illustrations refer to Cal. 7N33C.		(x 1.0)	
Movement size	Outside diameter		ø24.0 mm 21.5 mm between 12 o'clock and 6 o'clock sides 21.3 mm between 3 o'clock and 9 o'clock sides			
	Casing diameter		ø23.3 mm 21.5 mm between 12 o'clock and 6 o'clock sides 21.3 mm between 3 o'clock and 9 o'clock sides			
	Height		2.57 mm	2.78 mm	2.57 mm	
Time indication			3 hands		2 hands	
Driving system			Step motor (Load compensated driving pulse type)			
Additional mechanism			Date calendar			
			Instant setting device for date calendar			
		-	Day calendar	-		
		-	Instant setting device for day calendar	-		
			Train wheel setting device		-	
			Electronic circuit reset switch			
			Battery life indicator		-	
Loss/gain			Monthly rate at normal temperature range: less than 15 seconds			
Regulation system			Nil			
Measuring gate by quartz tester			Use 10-second gate.			
Battery			SEIKO SR920SW, Maxell SR920SW, Sony SR920SW, Matsushita SR920SW, Eveready 371 Battery life is approximately 5 years. Voltage: 1.55V			
Jewels			1 jewel			

PARTS CATALOGUE

Cal. 7N32C, 7N33C, 7N39C

Disassembling procedure Figs. : ① → ③⑥

Reassembling procedure Figs. : ③⑥ → ①

Lubricating: Types of oil

Oil quantity

● Moebius A

○ Normal quantity

Ex. : Cal. 7N33C

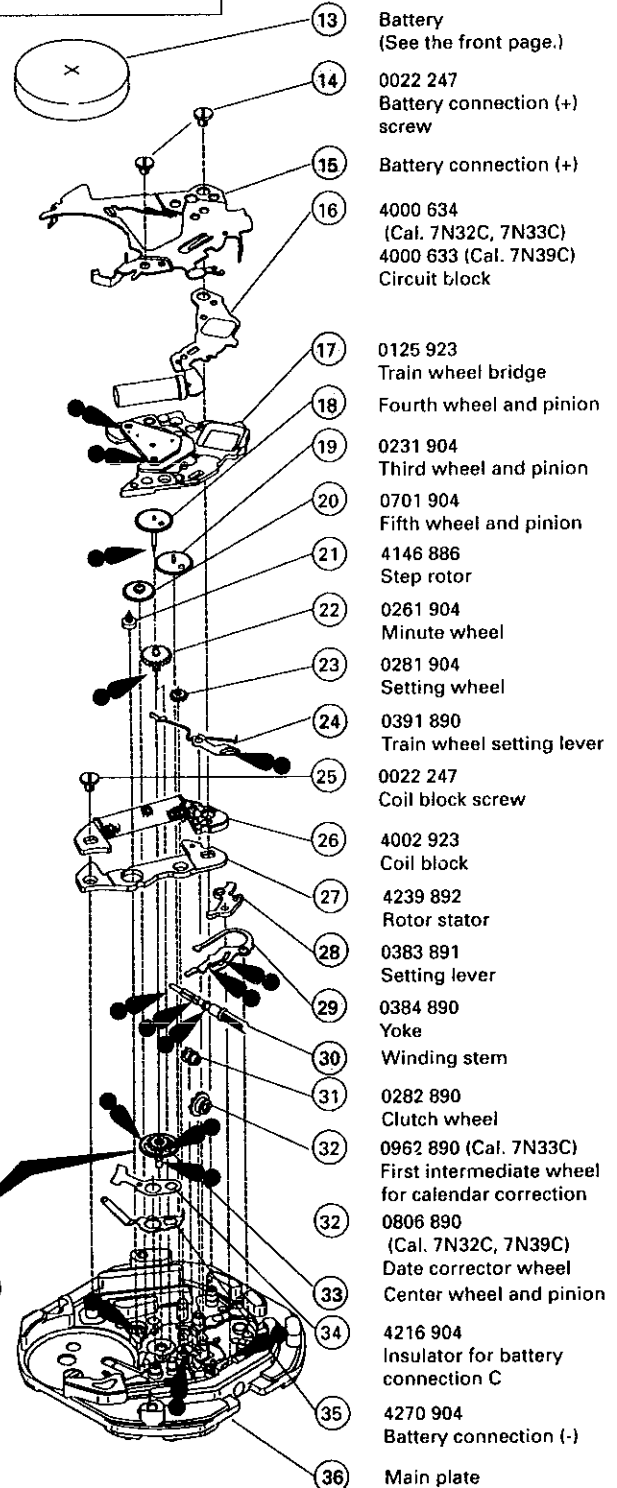
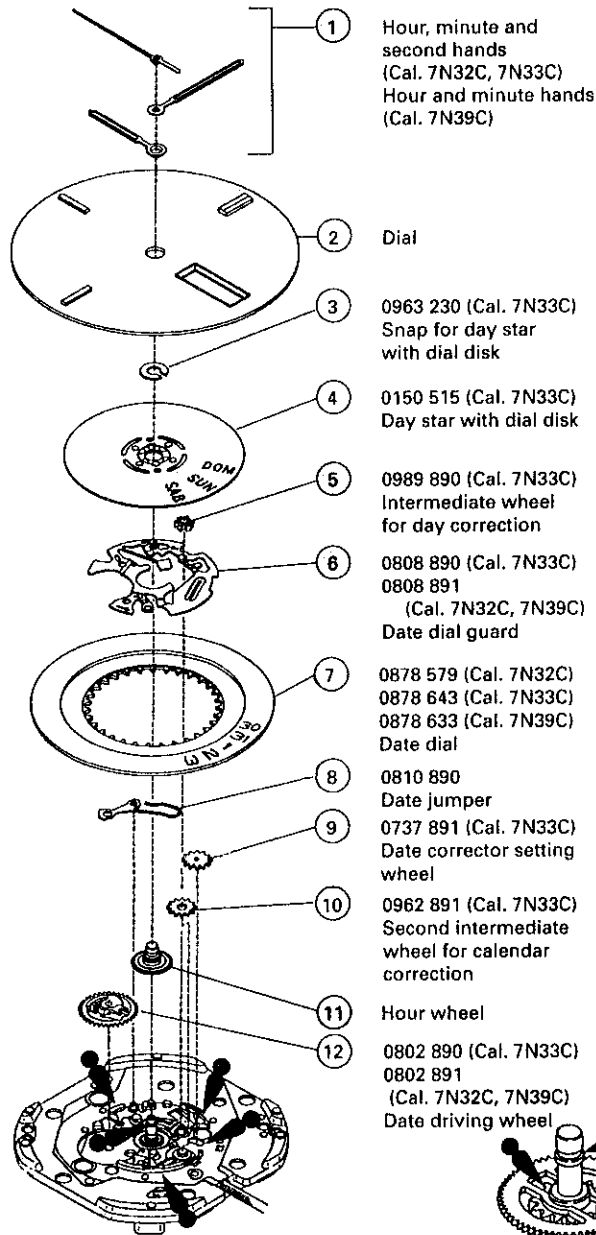

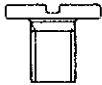
	0022 247 • Battery connection (+) screw (2 pcs.) • Coil block screw (1 pc.)
---	---

○ → Please see the remarks on the following pages.

PARTS CATALOGUE

Cal. 7N32C, 7N33C, 7N39C

Remarks:

- ⑪ Hour wheel
- ⑱ Fourth wheel and pinion
- ⑳ Center wheel and pinion
- ㉓ Main plate

• **Discrimination of the hand installation heights**



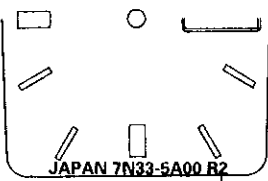
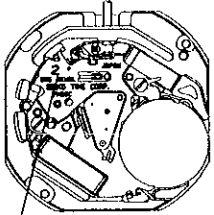



Cal. 7N Series watches have numerals printed on the dial and the movement to indicate the hand installation heights. When repairing, refer to the table below.

Discrimination	Height	Short type	Standard type
	Numeral for discrimination	1	2
	Printed on	Dial	Movement
	Printed position	<p>Ex) Standard type</p>  <p>JAPAN 7N33-5A00 R2</p> <p>The numeral is printed at the right end.</p>	<p>Ex) Standard type</p>  <p>The numeral is printed below the calibre number.</p>

Combination:

* The hand installation heights can be discerned from the shape of the following parts. Refer to the table below.

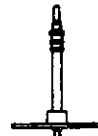

[Cal. 7N32C]

Numeral for discrimination	Center wheel and pinion	Fourth wheel and pinion	Hour wheel	Main plate (Center pipe)
1	 <p>0221 929</p>	 <p>0241 929</p>	 <p>0271 929</p>	 <p>0100 941</p>
2	 <p>0221 904</p>	 <p>0241 904</p>	 <p>0271 942</p>	 <p>0100 942</p>





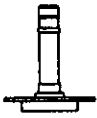
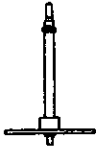

PARTS CATALOGUE

Cal. 7N32C, 7N33C, 7N39C

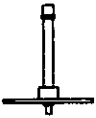
[Cal. 7N33C]

Numeral for discrimination	Center wheel and pinion	Fourth wheel and pinion	Hour wheel	Main plate (Center pipe)
2	 0221 934	 0241 934	 0271 934	 0100 943

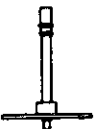
[Cal. 7N39C]

Numeral for discrimination	Center wheel and pinion	Fourth wheel and pinion	Hour wheel	Main plate (Center pipe)
1	 0221 929	 0241 940	 0271 929	 0100 941
2	 0221 904	 0241 941	 0271 942	 0100 942

⑮ Battery connection (+) 4268 620

Note: The battery connection (+) we are supplying has no calibre number nor numeral printed on it for discriminating the hand installation height.

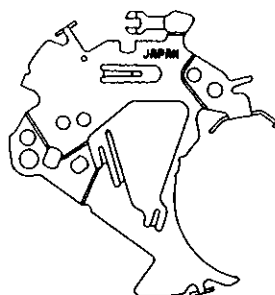

⑳ Winding stem 0351 892

The type of winding stem is determined based on the design of cases. Check the case number and refer to "SEIKO Casing Parts Catalogue" to choose a corresponding winding stem.

- The explanation here is only for the particular points of Cal. 7N32C, 7N33C and 7N39C.
- For the repairing, checking and measuring procedures, refer to the "TECHNICAL GUIDE, GENERAL INSTRUCTIONS".

I. STRUCTURE OF THE CIRCUIT BLOCK

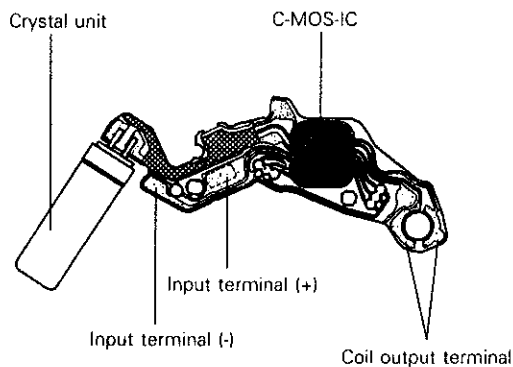

Note:

Though Cal. 7N32C, 7N33C and 7N39C have the same circuit block pattern, Cal. 7N39C is not provided with the battery indicator function. The circuit blocks of **Cal. 7N32C and 7N33C** have an identification mark as shown below to distinguish them from the circuit block of **Cal. 7N39C**.

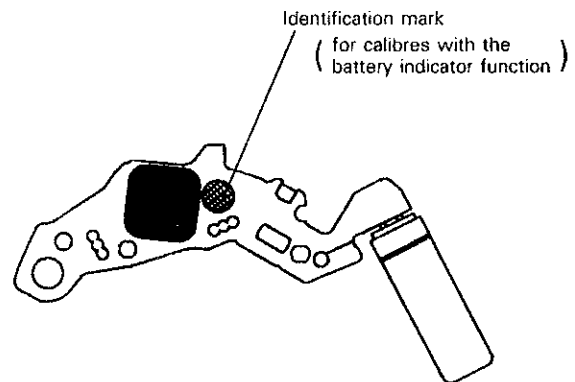

II. REMARKS ON DISASSEMBLING AND REASSEMBLING

Use the universal movement holder for disassembling and reassembling.

① Hands

• **How to install**

When installing the hands, remove the battery and place the movement directly on a flat metal plate or the like.

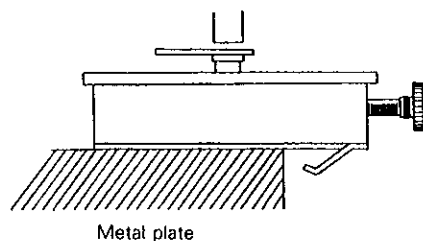

TECHNICAL GUIDE

Cal. 7N32C, 7N33C, 7N39C

⑤ Intermediate wheel for day correction (only for Cal. 7N33C)

Set the intermediate wheel for day correction in the direction as shown in the illustration at right.

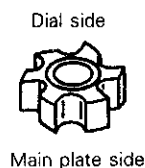

⑥ Date dial guard

Unlike conventional movements, the date dial guard is not fixed with screws. It is set to the main plate with the three protrusions, which are caught under the main plate by turning the guard. Then, it is fixed by the two guide pins.

• How to remove

- 1) Lightly lift the A portion of the date dial guard with tweezers to release it from the guide pin, and then move it in the counterclockwise direction until it gets on the guide pin.
- 2) Release the B portion of the date dial guard in the same way as described above, and then move it in the counterclockwise direction until it gets on the guide pin.
- 3) Check that all the three protrusions of the date dial guard have come off from the main plate, and then remove the date dial guard.

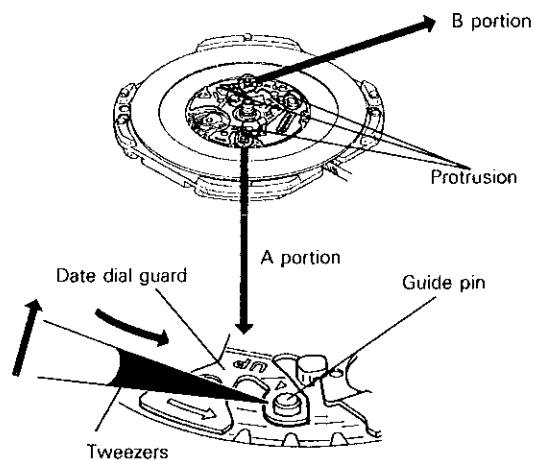

• How to install

- 1) Put the date dial guard on the main plate so that the A and B portions are over the guide pins, as shown in the illustrations at right.
- 2) Move the protrusion D of the date dial guard in the clockwise direction so that it is caught under the main plate.
- 3) Slightly move the protrusions C and E in the clockwise direction alternately to set them under the main plate. Then, set the A and B portions of the date dial guard to the guide pins.
- 4) Check that the date dial guard is fixed securely to the main plate.

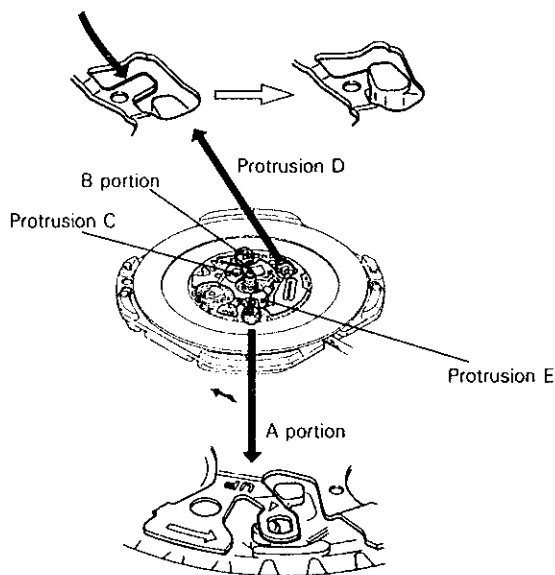

TECHNICAL GUIDE

Cal. 7N32C, 7N33C, 7N39C

⑬ Battery

• How to install

Insert the battery aslant from the direction shown by the arrow.

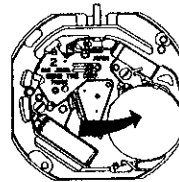

⑭ Battery connection (+) screw

Fasten the screw on the crystal unit side while holding down the edge of the crystal unit.

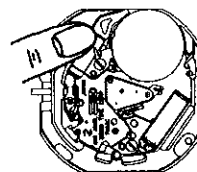

⑮ Battery connection (+)

• How to install

Have the hooking portion (2 places) catch the main plate.

In disassembling and reassembling, take care not to deform the hooking portions.

After installing the battery connection (+), check that the two hooking portions securely catch the main plate.

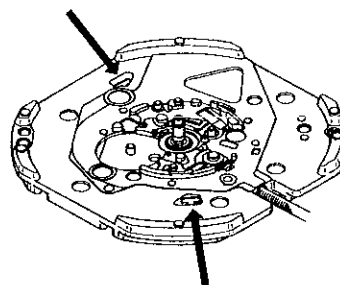

⑰ Train wheel bridge

• Setting position

Refer to the illustrations below.

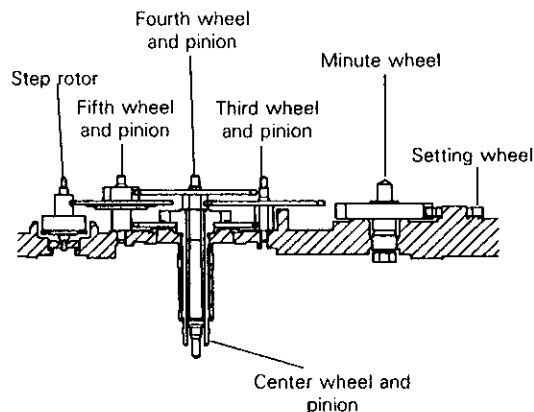
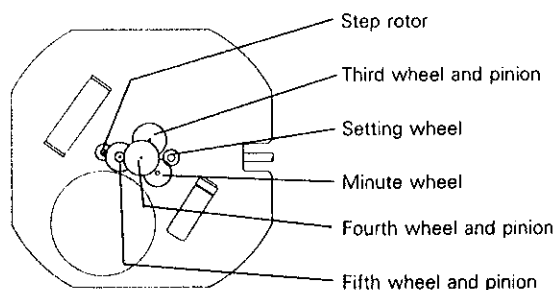

Note: Take care not to damage the wheels made of plastics in disassembling and reassembling.

- ②④ Train wheel setting lever
- ②⑧ Setting lever
- ②⑨ Yoke

• **Setting position**

Refer to the illustration at right.

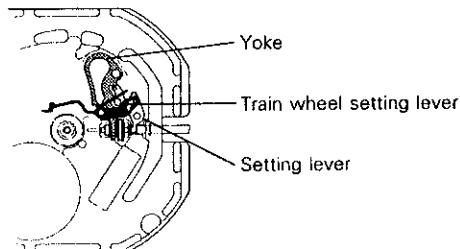

Note: Take care not to deform the spring portion of the yoke.

- ③⑩ Winding stem

The first intermediate wheel for calendar correction (Cal. 7N33C) or the date corrector wheel (Cal. 7N32C and 7N39C) has some elasticity in the contact with the winding stem so that it can be easily fixed. Push in the winding stem straight toward the center of the main plate.

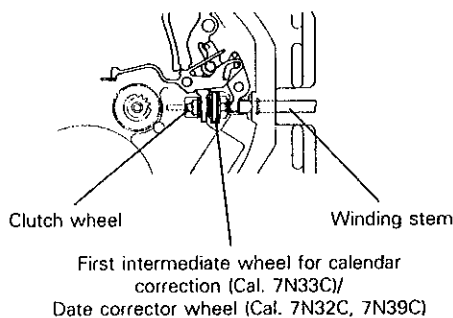

III. VALUE CHECKING

• **Coil block resistance**

1.18K Ω ~ 1.58K Ω

• **Current consumption**

- For the whole movement : less than 1.20 μ A
- For the circuit block alone : less than 0.28 μ A

Remarks: When the current consumption exceeds the standard value for the whole movement but within the standard value range for the circuit block alone, the watch is generating the driving pulse for compensating for the heavy load that may be applied to the gear train, etc. In this case, overhaul and clean the movement parts and then measure current consumption for the whole movement again.