

TECHNICAL GUIDE

SEIKO

QUARTZ

CAL. 8222A

CAL. 8223A

CAL. 8229A

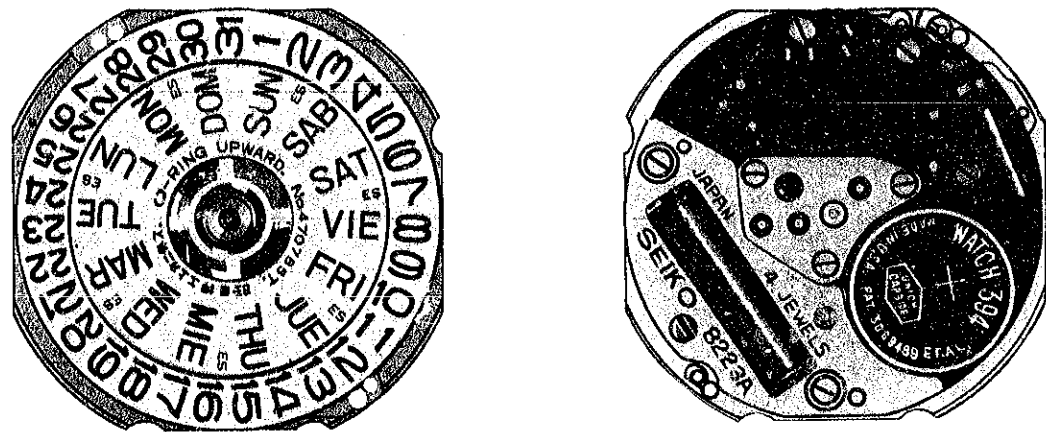

CONTENTS

I. SPECIFICATIONS	1
II. STRUCTURE OF THE CIRCUIT BLOCK	1
III. DISASSEMBLING, REASSEMBLING AND LUBRICATING	2
(1) Disassembling, reassembling and lubricating of the calendar mechanism and the dial side parts	3
(2) Disassembling, reassembling and lubricating of the circuit block, coil block and gear train mechanism	5
(3) Disassembling, reassembling and lubricating of the setting mechanism	6
IV. CHECKING AND ADJUSTMENT	7
• Check output signal	7
• Check hand setting condition	7
• Check battery voltage	7
• Check battery conductivity	7
• Check circuit block conductivity	7
• Check circuit block	7
• Check reset condition	7
• Check gear train mechanism	8
• Check setting mechanism and calendar mechanism	8
• Check accuracy	8
• Check current consumption	8
• Check water resistance	8
• Check appearance and functioning	8

I. SPECIFICATIONS

Item	Cal. No.	8222A	8223A	8229A (10 atm. water resistant)
Time indication		3-hand time indication (hour, minute and second)		
Additional mechanism	Date	Calendar (day and date)		
	Date setting (by turning the crown)	Bilingual changeover system for the day of the week		
		Instant day and date setting (by turning the crown)		
	Electronic circuit reset switch			
	Second setting device (stops at every second)			
Battery life indicator				
Loss/gain		Loss/gain at normal temperature range Monthly rate : less than 15 seconds (Annual rate : less than 3 minutes)		
Outside diameter		$\phi 26.0$ mm (23.4 mm between 3 o'clock and 9 o'clock sides, 23.7 mm between 12 o'clock and 6 o'clock sides)		
Casing diameter		$\phi 24.0$ mm		
Height		3.8 mm without battery		
Regulation system		Trimmer condenser		
Measuring gate by Quartz Tester		Any gate is available.		
Battery		U.C.C. 394 or Maxell SR 936SW Battery life is approximately 5 years. Voltage: 1.55 V		
Jewels		4 jewels		

II. STRUCTURE OF THE CIRCUIT BLOCK

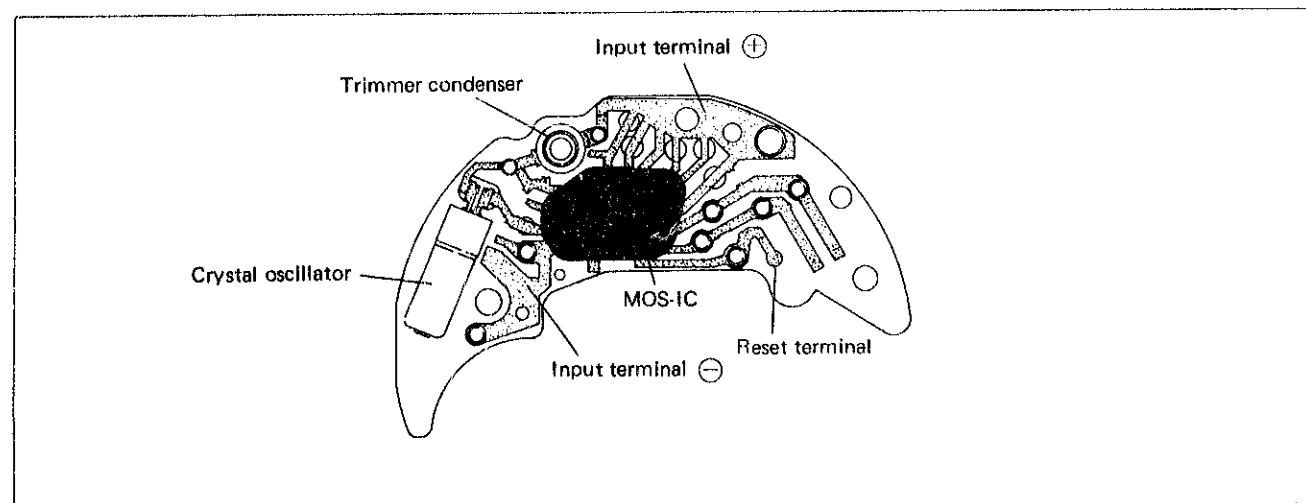

III. DISASSEMBLING, REASSEMBLING AND LUBRICATING

• Disassembling and reassembling

Disassembling procedures Figs.: ① ~ ③⑨

Reassembling procedures Figs.: ③⑨ ~ ①

• Lubricating

Types of oil		Oil quantity	
	Moebius A		Liberal
	SEIKO Watch Oil S-6		Extremely small
	Never lubricate the portions.		

• After-sale servicing instruments and materials

Use the movement holder S-667 or S-680 for Cal. 56 series.

• The following two types of screws are used for Cal. 82 series.

Shape	Parts No.	Parts Name	Shape	Parts No.	Parts Name
	022 256	Center wheel bridge screw (1 pc.)		022 744	Date dial guard screw (4 pcs.)
		Third wheel bridge screw (3 pcs.)			
		Circuit block screw (2 pcs.)			
		Anti-magnetic shield plate screw (2 pcs.)			
		Setting lever spring screw (1 pc.)			

(1) Disassembling, reassembling and lubricating of the calendar mechanism and the dial side parts

Ex: Cal. 8223A

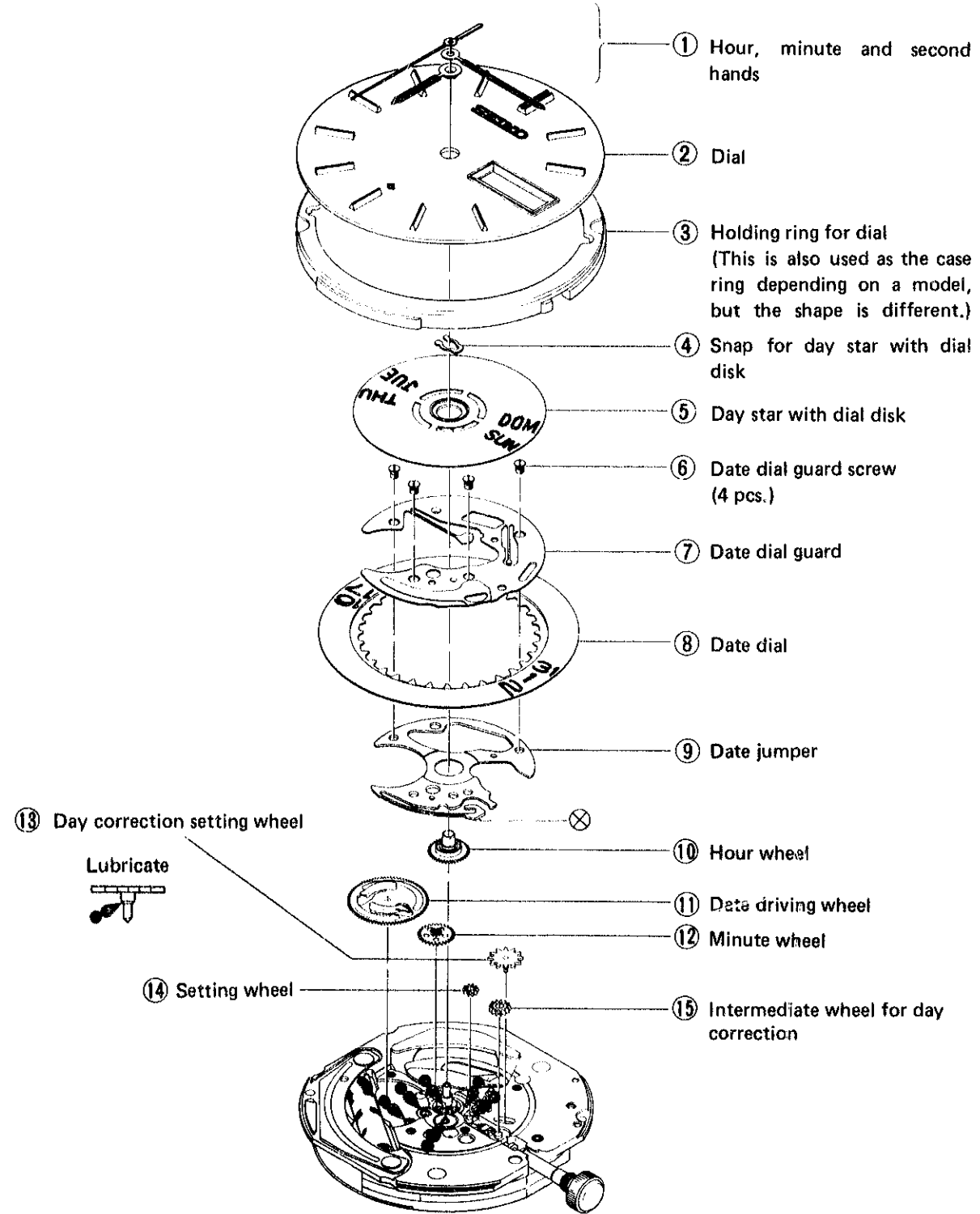

Remarks for disassembling and reassembling

① Hour, minute and second hands

- Pull out the crown to the second click, and disassemble and reassemble the hands.
- Be sure to set the second hand so that it comes just on the second scale.

② Dial

- Turn the eccentric dial pin as illustrated on the right, when the dial is disassembled or reassembled.

- When reassembling the eccentric dial pin, be sure to turn it so that it touches the dial leg.

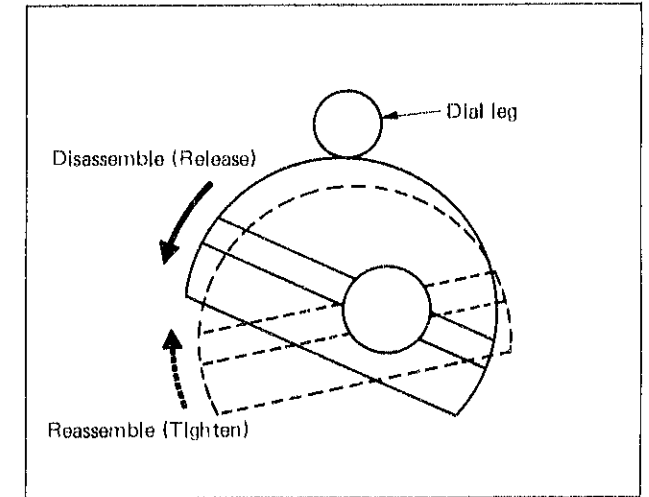

④ Snap for day star with dial disk

Remarks for disassembling

- Put the tip of a screwdriver as illustrated on the right and pry it up to remove the snap for day star with dial disk. Be careful not to bend the day star with dial disk and day star wheel, and not to scratch the hour wheel.

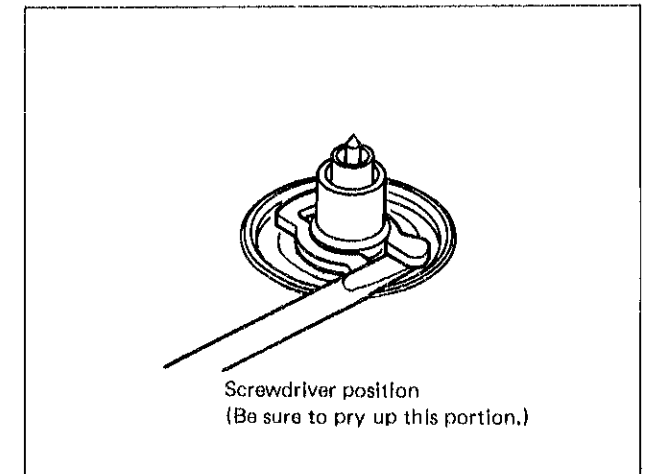

Remarks for reassembling

- Hold the snap for day star with dial disk with tweezers with its slot in line with the center axis and push it down.

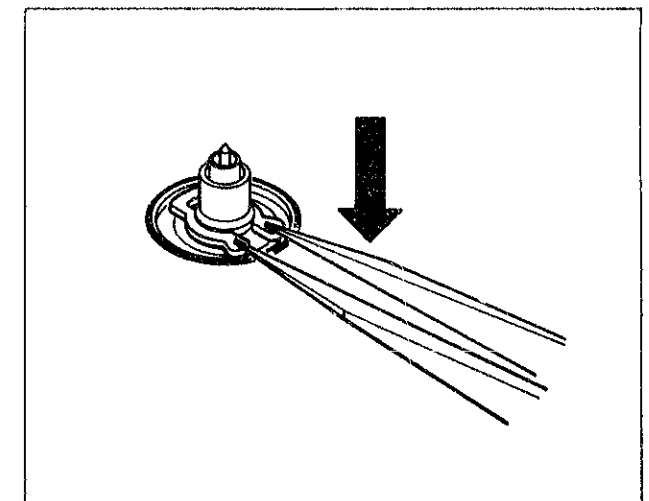

(2) Disassembling, reassembling and lubricating of the circuit block, coil block and gear train mechanism

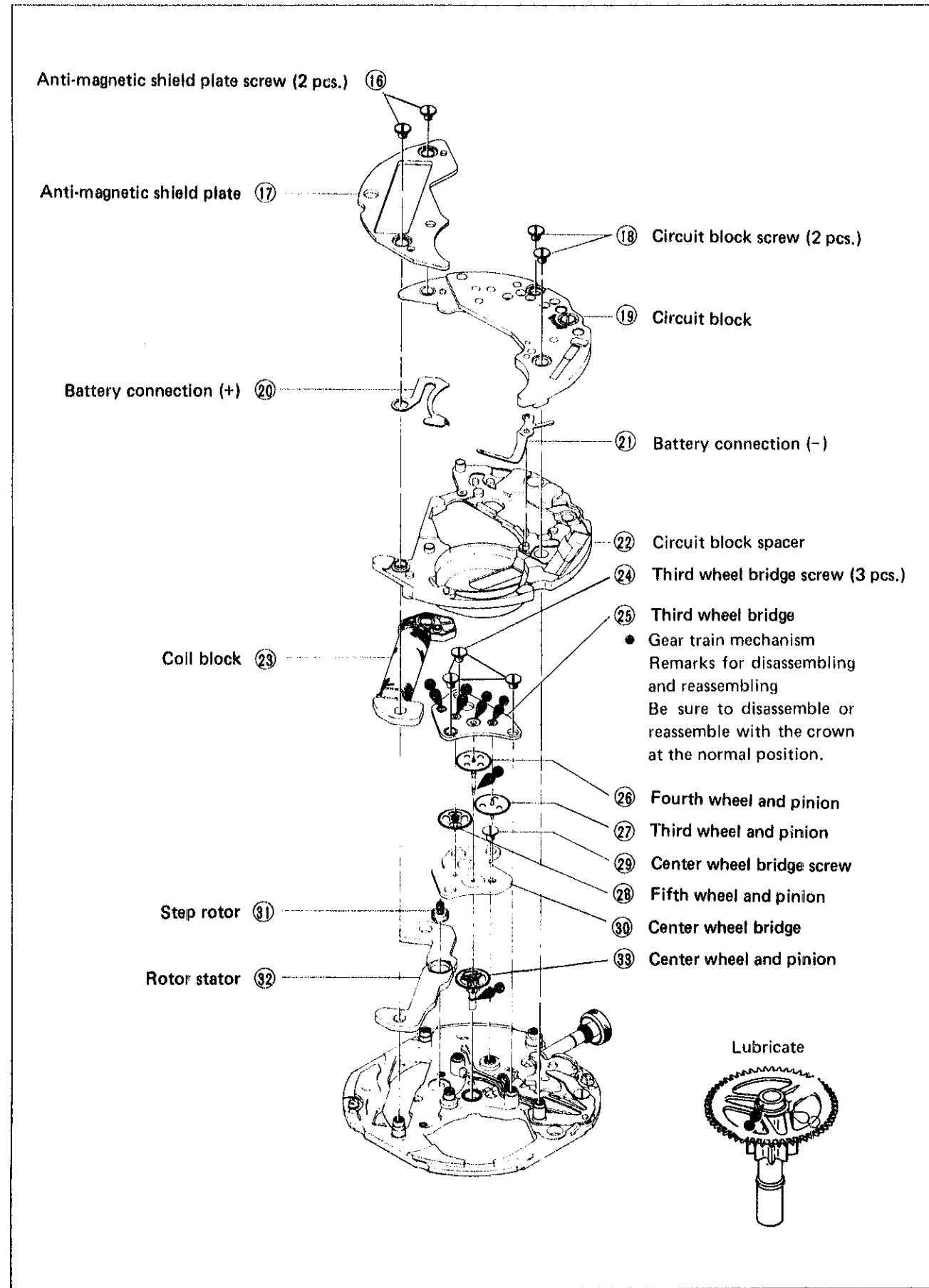

(3) Disassembling, reassembling and lubricating of the setting mechanism

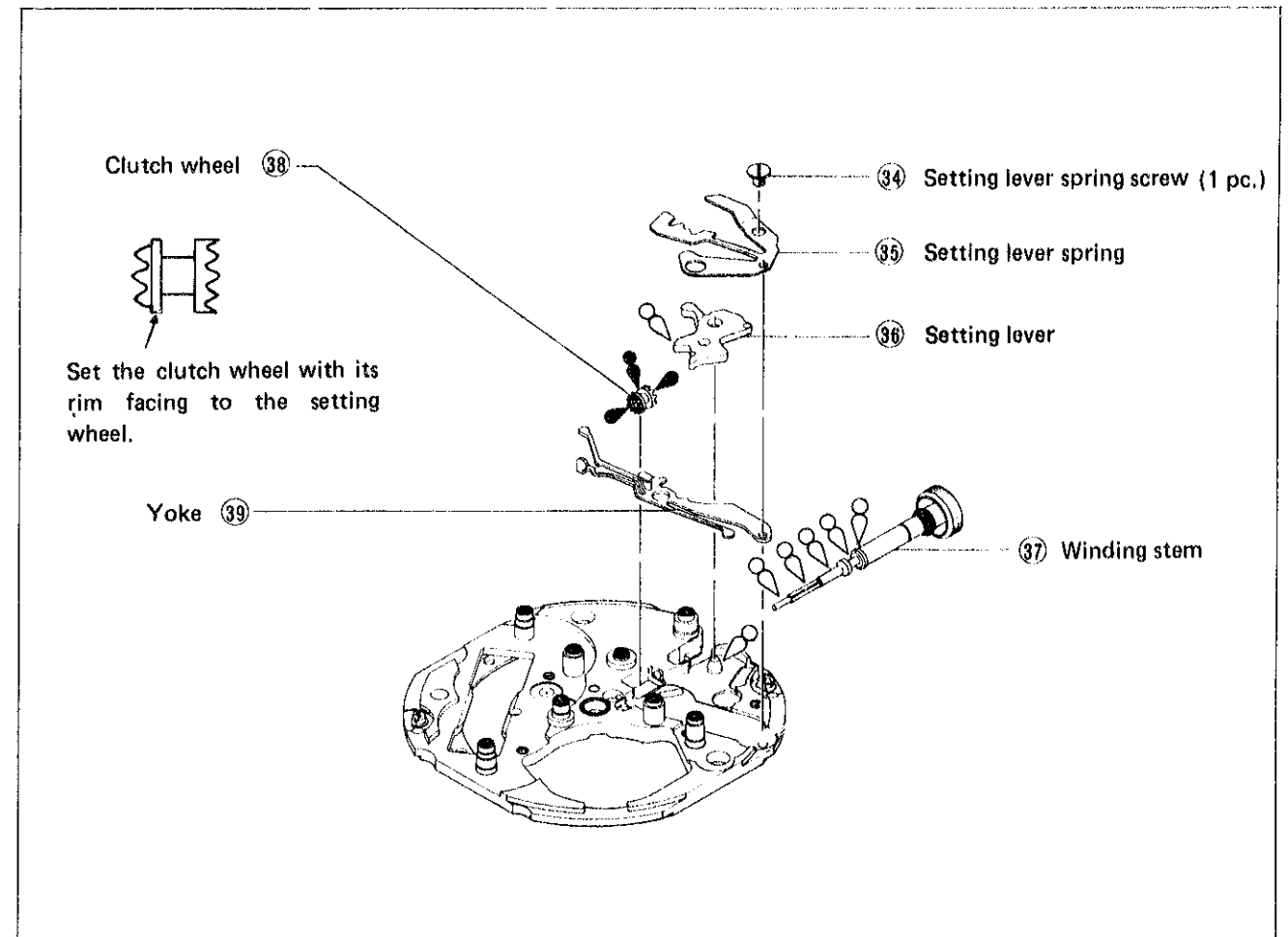

[Plan of the setting portion]

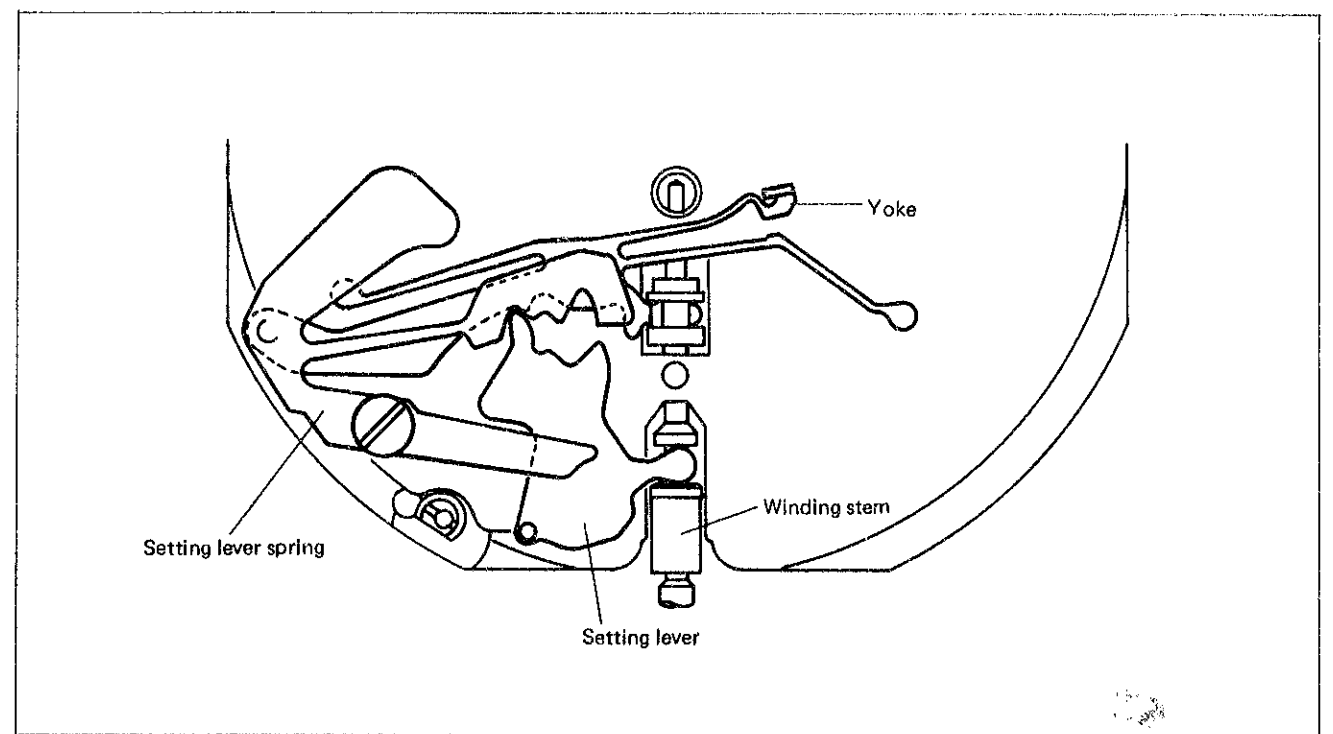

IV. CHECKING AND ADJUSTMENT

- Refer to the "SEIKO QUARTZ TECHNICAL GUIDE, GENERAL INSTRUCTION FOR ANALOGUE WATCHES" for details.

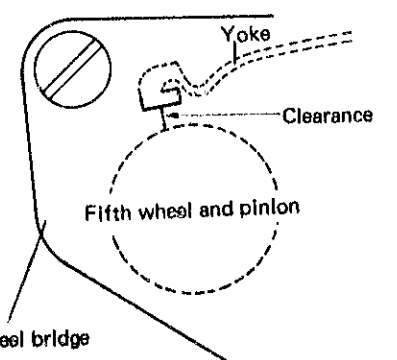
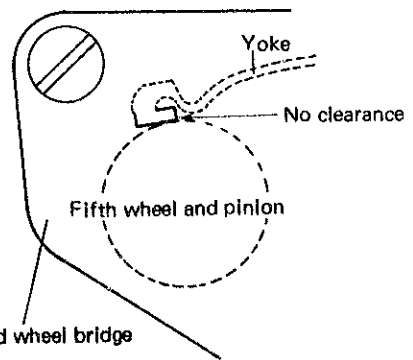
Procedure	
CHEK OUTPUT SIGNAL	<p>Result:</p> <p>One-second blinking Normal</p> <p>No one-second blinking Defective</p>
CHECK HAND SETTING CONDITION	
CHECK BATTERY VOLTAGE	<p>Result:</p> <p>More than 1.5 V Normal</p> <p>Less than 1.5V Defective</p>
CHECK BATTERY CONDUCTIVITY	
CHECK CIRCUIT BLOCK CONDUCTIVITY	
CHECK COIL BLOCK	<p>Result:</p> <p>$3k\Omega \sim 5k\Omega$ Normal</p> <p>Over $5k\Omega$ } Defective</p> <p>Less than $3k\Omega$ }</p>
CHECK RESET CONDITION	<p>(1) Check to see if there is a clearance between the yoke and the fifth wheel and pinion when the crown is at the normal position and when it is pulled out to the first click, and the yoke touches the fifth wheel and pinion when the crown is pulled out to the second click. (Check through the hole for the third wheel bridge by using a microscope.)</p> <p>Crown position: Normal and First click</p>  <p>Crown position: Second click</p> 

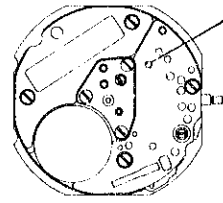
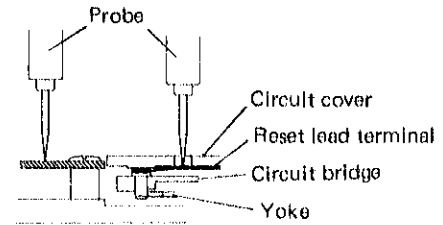
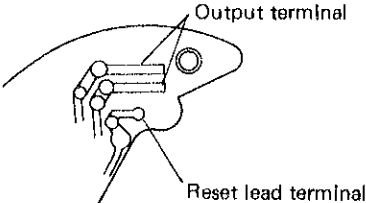
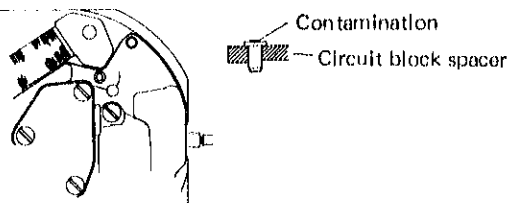
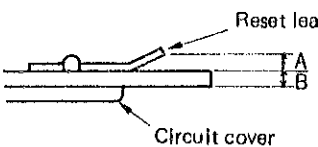
Procedure	
	<p>(2) After reassembling the circuit block and the battery, check to see if the second hand stops exactly when the crown is pulled out to the second click, and the second hand starts moving exactly one second after the crown is pushed back to the normal position.</p> <p>(3)</p> <p>1) With the crown at the second click, check conductivity of the reset lead terminal pattern and the third wheel bridge by using the Volt-ohm meter.</p>  <p>Check conductivity of the pattern which is seen through this hole and the third wheel bridge. (Range to be used: R x 1)</p>  <p>2) Remove the circuit block, and check any contamination on the connecting portion of the reset lead terminal and the reset pin by using a microscope.</p>   <p>3) Check to see if the reset lead terminal is bent.</p>  <p>Correct the reset lead terminal so that "A = B"</p>
CHECK GEAR TRAIN MECHANISM	
CHECK SETTING MECHANISM AND CALENDAR MECHANISM	
CHECK ACCURACY	
CHECK CURRENT CONSUMPTION	<p>Result:</p> <p>Less than $2.0\mu A$ Normal</p> <p>Over $2.0\mu A$ Defective</p>
CHECK WATER RESISTANCE	
CHECK APPEARANCE AND FUNCTIONING	

All procedures of Disassembling, Reassembling, Checking and Adjustment are completed.