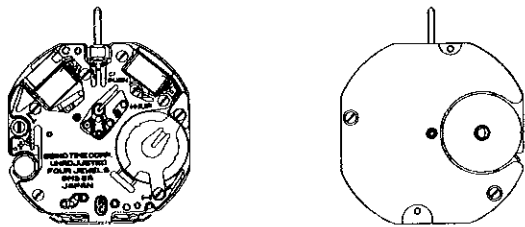

PARTS CATALOGUE/ TECHNICAL GUIDE

Cal. 8M26A

Cal. 8M32A

[SPECIFICATIONS]

Cal. No.		8M26A	8M32A
Item			
Movement		 <p>The illustrations refer to Cal. 8M26A. (x 1.0)</p>	
Movement size	Outside diameter	24.0mm between 6 o'clock and 12 o'clock sides 24.0mm between 3 o'clock and 9 o'clock sides	
	Casing diameter	φ25.5mm	
	Height	3.0mm (including the battery portion)	
Time indication		2 hands and mode indicator	
Driving system		Step motor (Fixed-width pulse system, 2 pcs.)	
Additional mechanism		Stopwatch	
		Countdown timer	
		Alarm	Repeat timer
		Timer-stopwatch	
		Hands 0-reset adjustment function	
		Electronic circuit reset switch	
		Alarm test system	
Demonstration movement of the hands			
Loss/gain		Monthly rate at normal temperature range: less than 15 seconds	
Regulation system		Trimmer condenser	
Measuring gate by quartz tester		Use 60-second gate.	
Battery		SEIKO SR920W, Maxell SR920W Battery life is approximately 2.5 years. Voltage: 1.55V	
Jewels		4 jewels	

HATTORI SEIKO CO., LTD.

PARTS CATALOGUE

Cal. 8M26A, 8M32A

Disassembling procedures Figs.: (1) → (38)

Reassembling procedures Figs.: (38) → (1)

Lubricating: Types of oil

 Silicone oil 500,000 c.s.

 Moebius A

 SEIKO Watch Oil S-6

Oil quantity

 Normal quantity

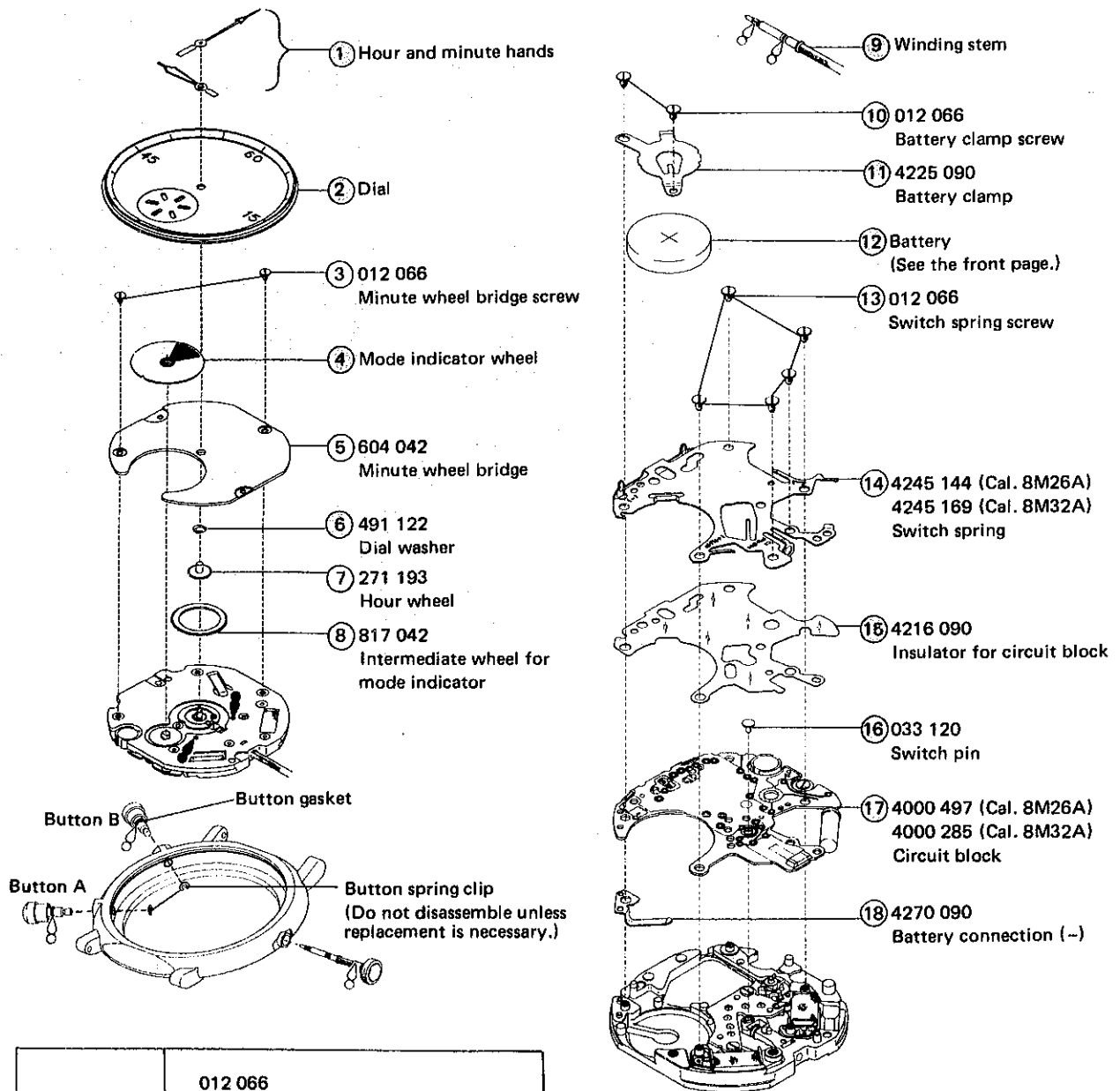

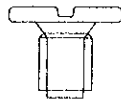
	012 066
	• Minute wheel bridge screw (2 pcs.)
	• Battery clamp screw (2 pcs.)
	• Switch spring screw (5 pcs.)
	• Train wheel bridge screw (2 pcs.)

 Please see the remarks on the following pages.

PARTS CATALOGUE

Cal. 8M26A, 8M32A

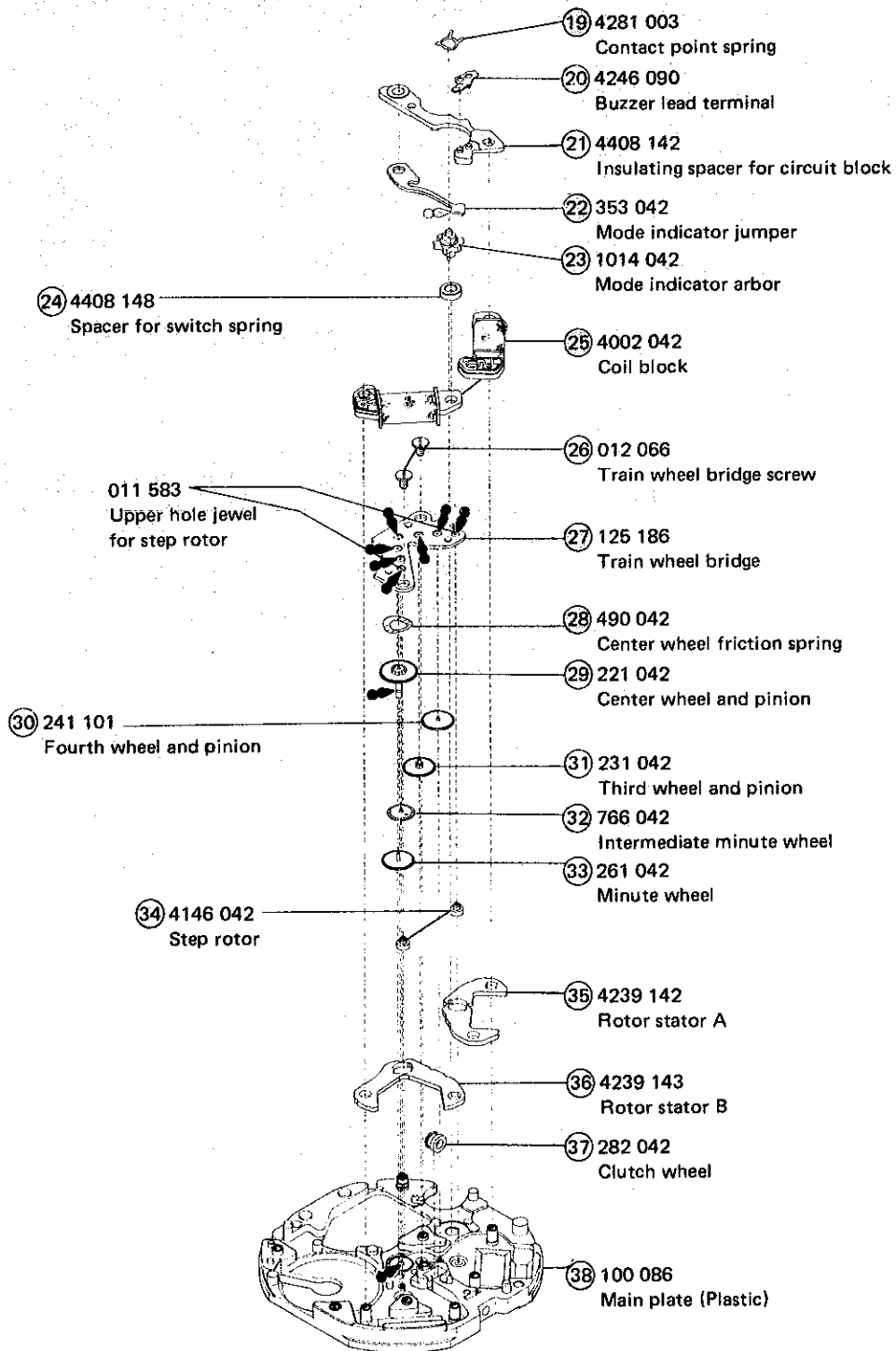

PARTS CATALOGUE

Cal. 8M26A, 8M32A

Remarks:

④ Mode indicator wheel

- Cal. 8M26A
 - 1021 271 Red figure on black ground
 - 1021 272 Red figure on white ground
- Cal. 8M32A
 - 1021 272 Red figure on white ground
 - 1021 278 Black figure on white ground
 - 1021 283 Green figure on black ground

Note: The type of mode indicator wheel is determined based on the color of dial.

⑨ Winding stem 351 148

The type of winding stem is determined based on the design of case.
Check the case number and refer to "SEIKO Casing Parts Catalogue" to choose a corresponding winding stem.

⑰ Circuit block

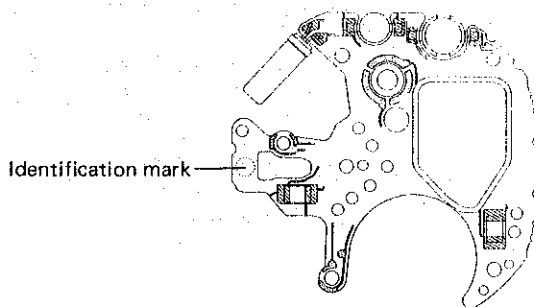

Note:

Circuit blocks for Cal. 8M Series have the same appearance, and a mark is printed at the position indicated in the illustration to identify the circuit blocks for respective calibres. For the identification marks, please refer to the table below.

Calibre	Part No.	Identification mark	Calibre	Part No.	Identification mark
8M11	4000 282	A	8M32	4000 285	D
8M15	4000 283	B	8M35	4000 286	E
8M18	4000 383	C	8M37	4000 287	F
8M25, 8M26	4000 497	No mark			

- Other parts

Piezoelectric element 4589 650

- The explanation here is only for the particular points of Cal. 8M26A and 8M32A.
- For the repairing, checking and measuring procedures, refer to the "TECHNICAL GUIDE, GENERAL INSTRUCTIONS".

I. STRUCTURE OF THE CIRCUIT BLOCK

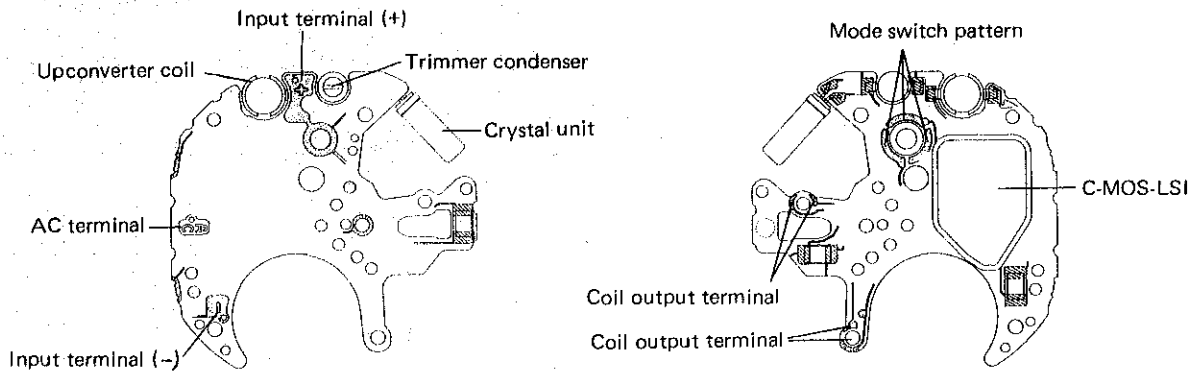

II. REMARKS ON DISASSEMBLING AND REASSEMBLING

① Hands

Since a plastic main plate is used, place the movement on a flat metal plate or the like, and then install the hands at the 12 o'clock position.

In doing so, check that the buzzer lead terminal and the two protrusions of the switch spring are not pressed down as they protrude toward the case back side.

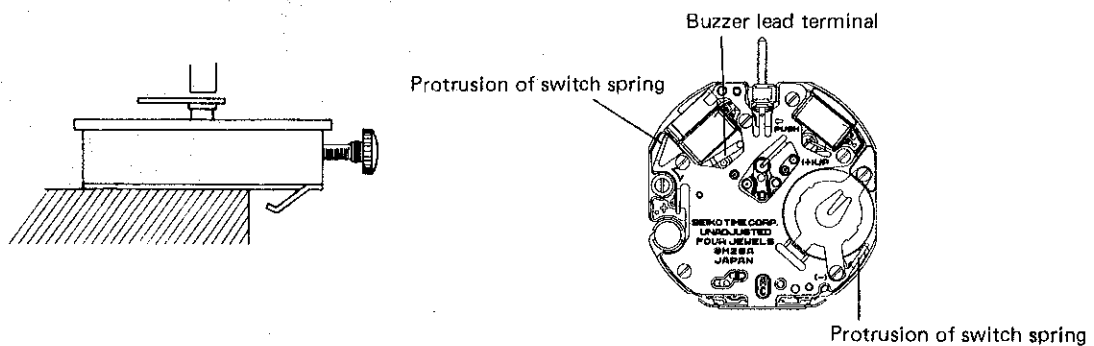

② Dial

• How to remove

Pry up the dial at the two recessed parts indicated in the illustration using a screwdriver.

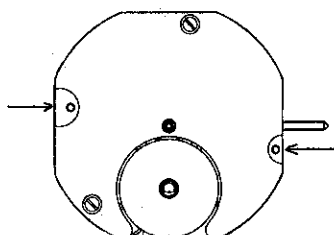

⑥ Dial washer

②⑧ Center wheel friction spring

- How to distinguish the two parts

[Dial washer]



- Bent
- With the smaller diameter

[Center wheel friction spring]

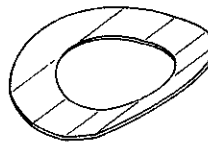

- Bent
- With the larger diameter

⑨ Winding stem

- How to remove

Remove the winding stem while pushing the indented portion of the switch spring (marked with "← PUSH").

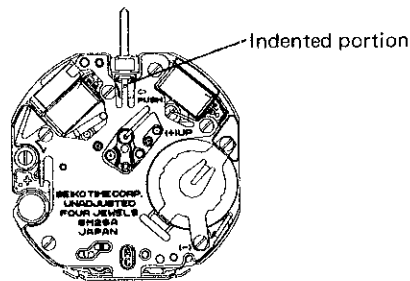

⑪ Battery clamp

- How to install

Slip the tip of the battery clamp into a gap under the switch spring.

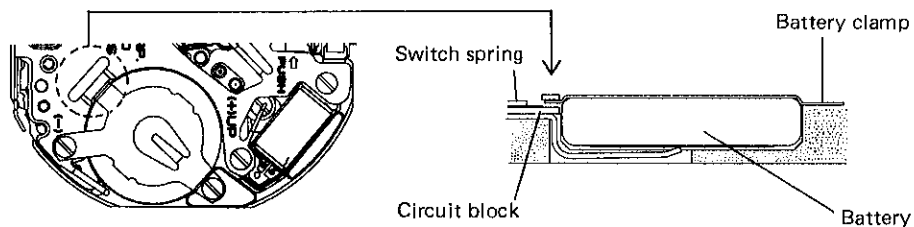

⑫ Battery

• A necessary step after installing the battery

After the battery is replaced with a new one, or after the battery is removed and re-installed following the repairing procedures, be sure to short-circuit the AC terminal of the circuit block and the battery clamp twice with conductive tweezers to reset the circuit. (When checking the current consumption, short-circuit with the power supplied from external source.)

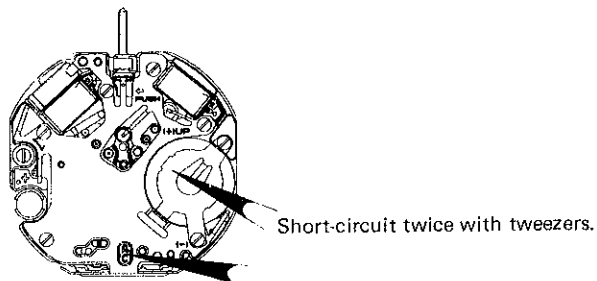

* The circuit can be reset with a complete watch. Follow the procedure below.

- [1] Turn the crown to set the mode indicator to " $\rightarrow \phi \leftarrow$ ".
- [2] Pull out the crown to the first click.
- [3] Keep buttons "A" and "B" pressed at the same time for approximately 3 seconds.
When the buttons are released, a beep sounds and the hour and minute hands start moving counterclockwise and clockwise, respectively.
- [4] Press button "A" or "B" once to stop the hands.
- [5] Press button "A" and "B" repeatedly but separately to reset the minute and hour hands respectively to the "0" position (12 o'clock position).
- [6] Turn the crown to set the mode indicator to "TIME".
Then, pull out the crown to the first click, and press button "A" and "B" repeatedly but separately to set the minute and hour hands respectively to the desired time.

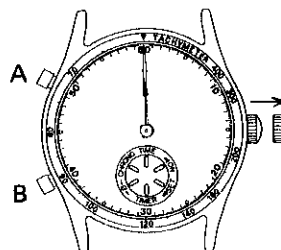

⑮ Insulator for circuit block

The insulator for circuit block is colorless and transparent. Therefore, make sure that it is installed without fail.

⑩ Switch pin

If failure of time setting or hands 0-reset adjustment function occurs with the crown at the first click, check if proper clearance is provided between the switch pin and circuit block.

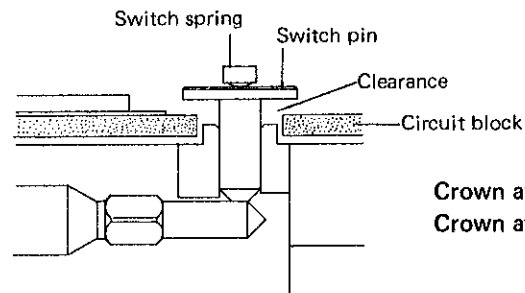

Crown at the normal position : Clearance provided.
Crown at the first click : No clearance provided.

⑪ Circuit block

⑬ Contact point spring

If a malfunction occurs in any of the modes, check the following points.

[1] Check if the following parts are set as shown below.

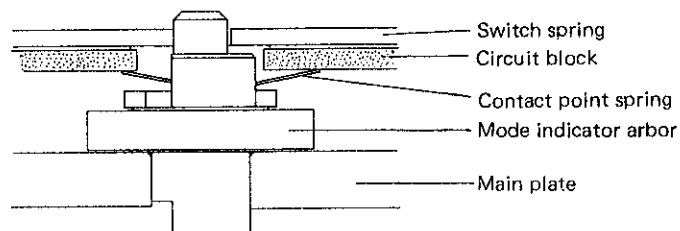

[2] Check if the contact point spring is deformed.

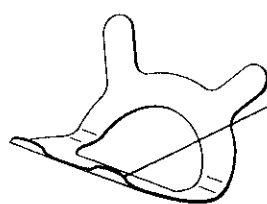

Especially check the contact parts with the circuit block for deformation.

②② Mode indicator jumper

Take care not to deform the mode indicator jumper when disassembling or reassembling it, as extremely high pressure is applied to it.

● How to remove

Release the tip of the mode indicator jumper from the mode indicator arbor, and then lift up "A" portion in the illustration.

● How to install

Reverse the procedures for disassembling.

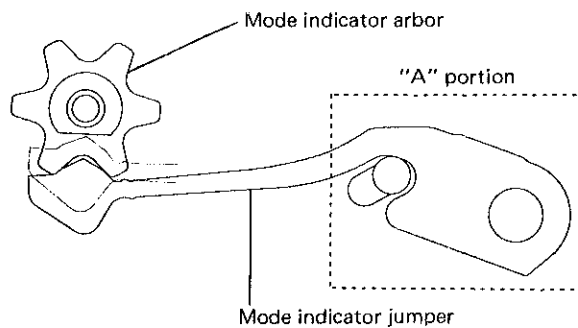

②⑤ Coil block

Two coil blocks can be used interchangeably.

②⑦ Train wheel bridge



②⑧ Center wheel friction spring

③④ Step rotor

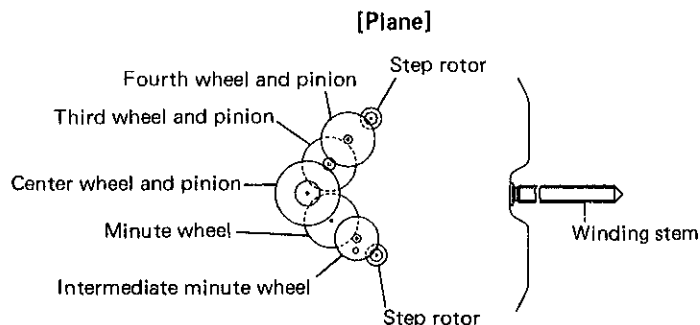
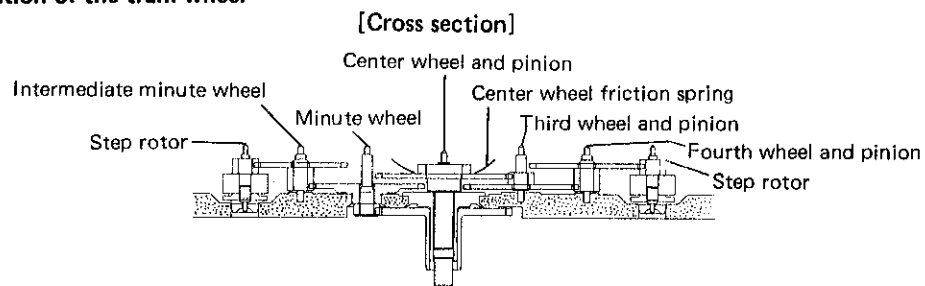
● Setting position of the train wheel

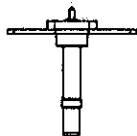

- Do not deform the center wheel friction spring, as this will cause the watch to stop or lose.
- Two step rotors can be used interchangeably.
- Distinction of wheels

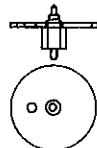
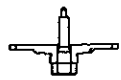
Name	Center wheel and pinion	Third wheel and pinion	Fourth wheel and pinion	Intermediate minute wheel	Minute wheel
Shape					
Distinctive feature	Tall in height	Short pinion	Long pinion	A hole on wheel	No pivot

III. VALUE CHECKING

- Coil block resistance
1.2K Ω ~ 1.6K Ω
- Upconverter coil resistance
120 Ω ~ 180 Ω
- Measuring time accuracy

Turn the crown to set the mode indicator to "TIME" or "ON".

Since the minute hand moves at 12-second intervals, use 60-second gate of the quartz tester to measure accuracy.

* Time accuracy can also be measured with the mode indicator set at "TIMER" or "CHRONO". In this case, any gate of the quartz tester can be used to measure the daily rate.

- Current consumption

For the whole of the movement: less than 2.5 μ A

For the circuit block alone : less than 1.6 μ A

Note:

Before measuring current consumption, it is necessary to reset the circuit with the power supplied from an external source. Therefore, follow the procedures below to measure the current consumption.

Measure the current consumption for the whole of the movement.

(Make sure that the battery clamp screw is securely tightened.)

- [1] Install the dial and mode indicator, and turn the crown to set the mode indicator to "TIME" or "ON".
- [2] Short-circuit the "AC" pattern of the circuit block and the switch spring twice to reset the circuit.
- [3] Press button "A" or "B" once.

TECHNICAL GUIDE

[4] The minute hand start moving at 12-second intervals. Read the maximum value of the current consumption, and calculate the current consumption per second.

Note that measurement obtained while the hands are not moving corresponds to the current consumption for the circuit block alone.

(For details, refer to Chapter 5 "MEASUREMENT" of the "TECHNICAL GUIDE, GENERAL INSTRUCTIONS".)