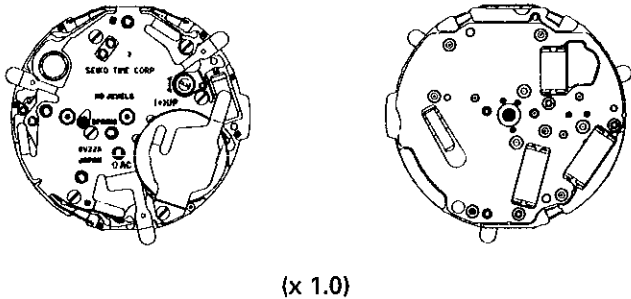

# PARTS CATALOGUE / TECHNICAL GUIDE

## Cal. 8V22A

### [SPECIFICATIONS]

Item		Cal. No.	8V22A
Movement			 <p>(x 1.0)</p>
Movement size	Outside diameter		ø29.1mm
	Casing diameter		—
	Height		3.3mm (3.8mm including the battery portion)
Time indication			3 hands and 24-hour hand
Driving system			Step motor (Fixed-width pulse system, 3 pcs.)
Additional mechanism			<ul style="list-style-type: none"> <li>• Alarm (24-hour indication system)</li> <li>• World time (12 time zones)</li> <li>• Dual time</li> <li>• Hands 0-reset adjustment function</li> <li>• Alarm test system</li> <li>• Confirmation sound for watch operation</li> </ul>
Loss/gain			Monthly rate at normal temperature range: less than 20 seconds
Regulation system			Trimmer condenser
Measuring gate by quartz tester			Any gate can be used.
Battery			SEIKO SR1130W, Maxell SR1130W, SONY SR1130W, EVEREADY 389 Battery life is approximately 2 years. Voltage: 1.55V
Jewels			0 jewel

SEIKO CORPORATION

# PARTS CATALOGUE

Cal. 8V22A

Disassembling procedures Figs. :

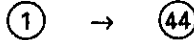

Reassembling procedures Figs. :

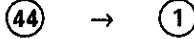

Lubricating: Types of oil

Moebius A

Oil quantity

Normal quantity

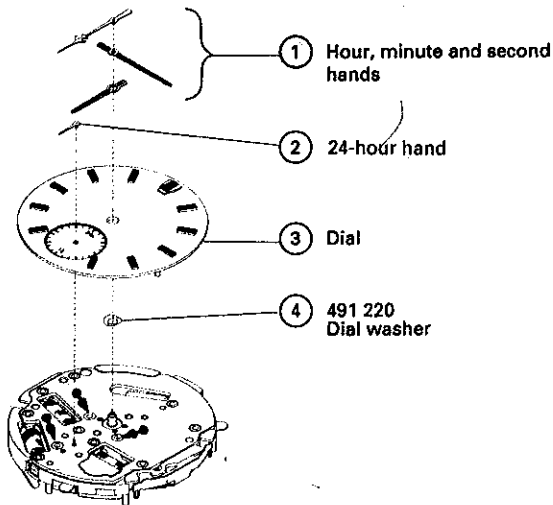

1 Hour, minute and second hands

2 24-hour hand

3 Dial

4 491 220  
Dial washer

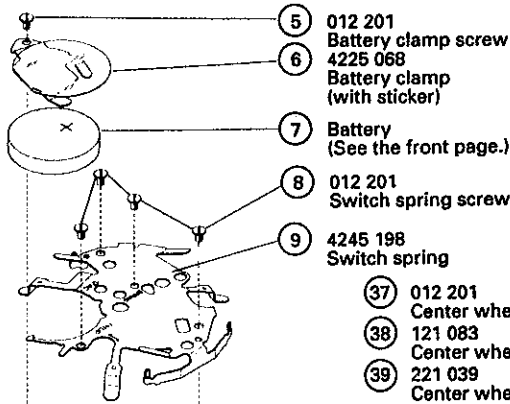

5 012 201  
Battery clamp screw

6 4225 068  
Battery clamp  
(with sticker)

7 Battery  
(See the front page.)

8 012 201  
Switch spring screw

9 4245 198  
Switch spring

37 012 201  
Center wheel bridge screw

38 121 083  
Center wheel bridge

39 221 039  
Center wheel and pinion

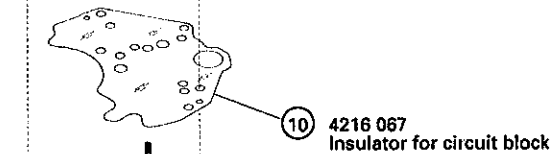

10 4216 067  
Insulator for circuit block

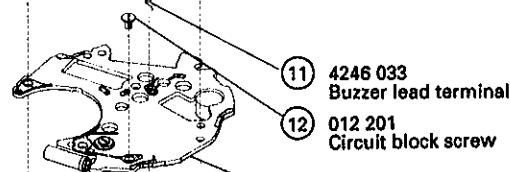

11 4246 033  
Buzzer lead terminal

12 012 201  
Circuit block screw

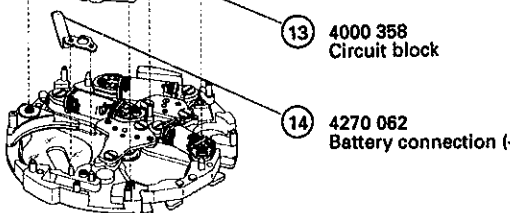

13 4000 358  
Circuit block

14 4270 062  
Battery connection (-)

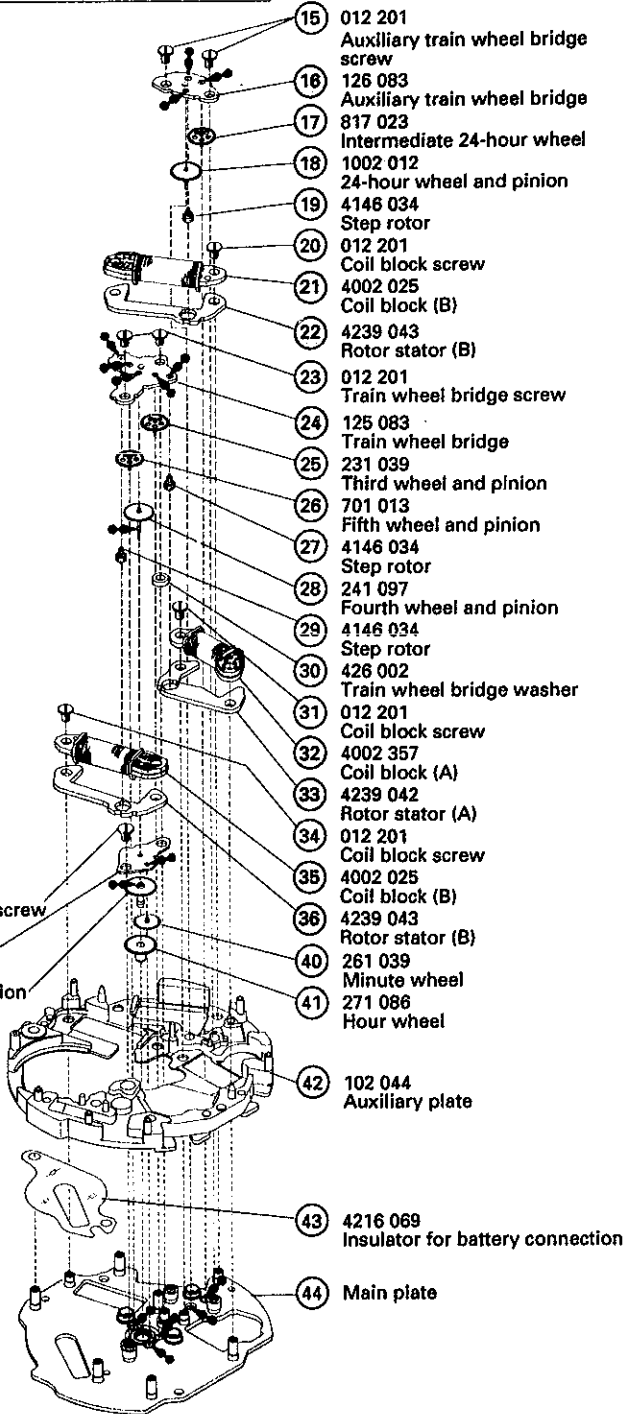

15 012 201  
Auxiliary train wheel bridge  
screw

16 126 083  
Auxiliary train wheel bridge

17 817 023  
Intermediate 24-hour wheel

18 1002 012  
24-hour wheel and pinion

19 4146 034  
Step rotor

20 012 201  
Coil block screw

21 4002 025  
Coil block (B)

22 4239 043  
Rotor stator (B)

23 012 201  
Train wheel bridge screw

24 125 083  
Train wheel bridge

25 231 039  
Third wheel and pinion

26 701 013  
Fifth wheel and pinion

27 4146 034  
Step rotor

28 241 097  
Fourth wheel and pinion

29 4146 034  
Step rotor

30 426 002  
Train wheel bridge washer

31 012 201  
Coil block screw

32 4002 357  
Coil block (A)

33 4239 042  
Rotor stator (A)

34 012 201  
Coil block screw

35 4002 025  
Coil block (B)

36 4239 043  
Rotor stator (B)

40 261 039  
Minute wheel

41 271 086  
Hour wheel

42 102 044  
Auxiliary plate

43 4216 069  
Insulator for battery connection

44 Main plate

○ ➔ Please see the remarks on the following pages.

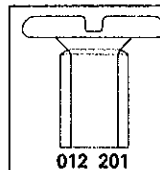

012 201

Battery clamp screw	(1 pc.)
Switch spring screw	(4 pcs.)
Coil block screw	(3 pcs.)
Circuit block screw	(1 pc.)
Auxiliary train wheel bridge screw	(2 pcs.)
Train wheel bridge screw	(2 pcs.)
Center wheel bridge screw	(1 pc.)

**Remarks:**

- Other parts  
Piezoelectric element 4589 650

## TECHNICAL GUIDE

- The explanation here is only for the particular points of Cal. 8V22.
- For the repairing, checking and measuring procedures, refer to the "TECHNICAL GUIDE, GENERAL INSTRUCTIONS"

### I. STRUCTURE OF THE CIRCUIT BLOCK

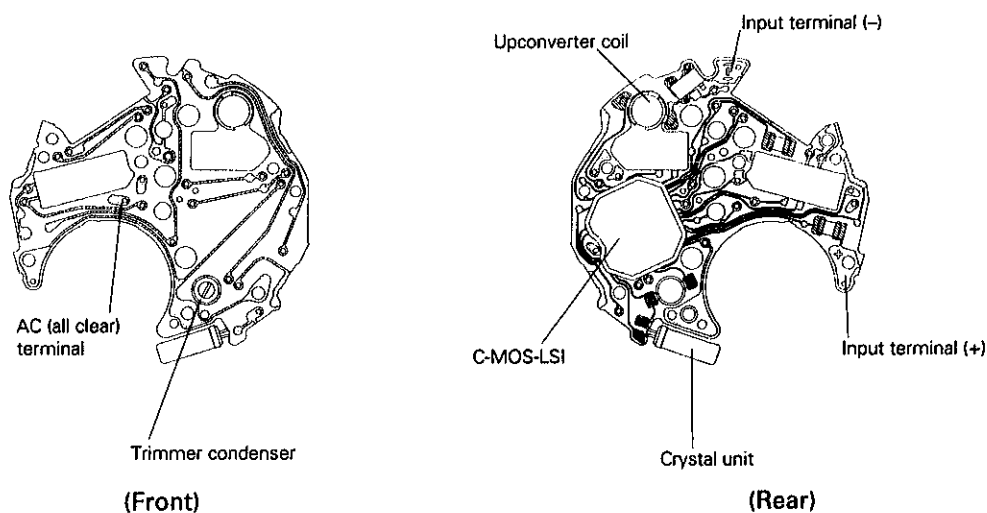

### II. REMARKS ON DISASSEMBLING AND REASSEMBLING

Use the universal movement holder for disassembling and reassembling.

- ① Hands

- **Remarks on installing**

When installing the hands, remove the battery and place the movement directly on a flat metal plate or the like.

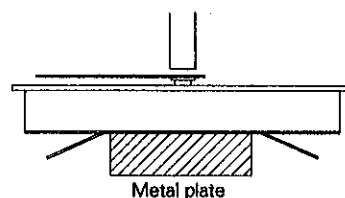

# TECHNICAL GUIDE

Cal. 8V22A

## ⑦ Battery

### • A necessary step after installing the battery

Immediately after the battery is replaced, be sure to act the system reset according to any one of the following manners:

- 1) Keep the three buttons pressed simultaneously for a few seconds.
- 2) Short-circuit the AC (all clear) terminal of the circuit block and switch spring with conductive tweezers to reset the circuit.

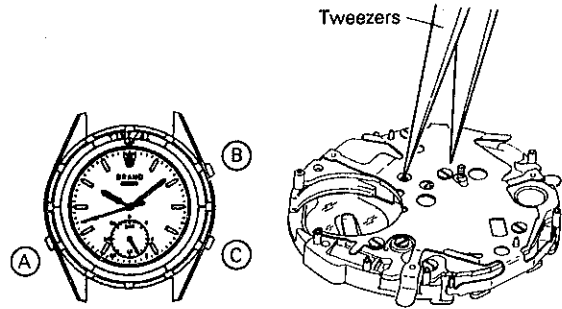

## ⑩ Auxiliary train wheel bridge

### • Setting position

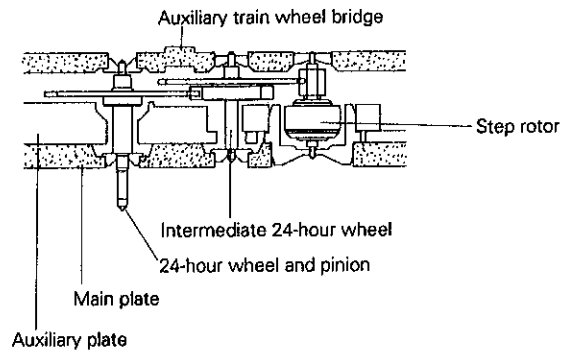

- ②① ③⑤ Coil block (B)
- ③② Coil block (A)
- ②② ③⑥ Rotor stator (B)
- ③③ Rotor stator (A)

### • Setting position

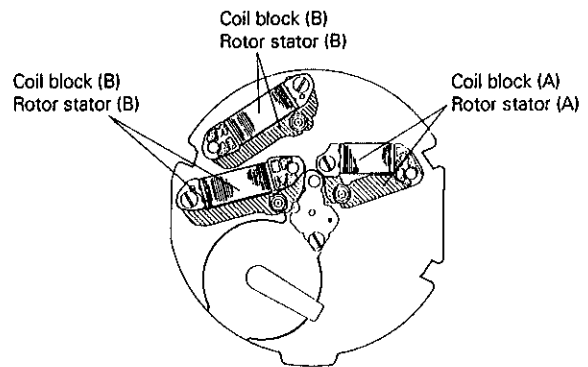

## ⑭ Train wheel bridge

### • Setting position of the train wheel

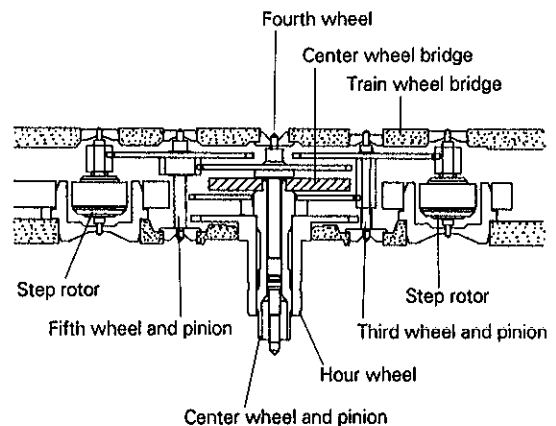

## III. VALUE CHECKING

- Coil block resistance

Coil block (A) : 1.2K $\Omega$  ~ 1.8K $\Omega$

Coil block (B) : 1.9K $\Omega$  ~ 2.3K $\Omega$

- Upconverter coil resistance

130 $\Omega$  ~ 170 $\Omega$

- Current consumption

For the whole of the movement : less than 4.0 $\mu$ A

For the circuit block alone : less than 1.9 $\mu$ A