

SEIKO

QUARTZ LC

Cal.A031A

PARTS LIST

Calibre No. <h1 style="text-align: center;">A031A</h1>	Jewels <h1 style="text-align: center;">0j</h1>	Style Name <h1 style="text-align: center;">QUARTZ LC ALARM</h1>
--	--	---

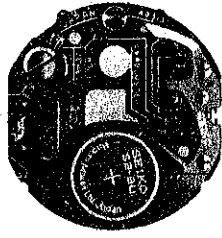
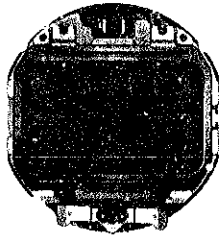

Characteristics

Casing diameter: φ28.40 mm
 Maximum height: 6.75 mm
 Frequency of quartz crystal oscillator: 32,768 Hz
 (Hz=Hertz..... Cycle per second)
 Time functions: 24 hour Digital Display System showing hour, minute & second.
 The dots blink once every second.
 Alarm function: Alarm setting in 24 hours by pushing the changeover button.
 Alarming time is 20 seconds.
 Also with alarm stop device
 Calendar functions: Date mark and date digits by simply depressing the front button
 Display medium: Single Crystal Display (Nematic Liquid Crystal, FE-Mode)
 Time micro-adjustor: Trimmer condenser system
 Illumination light for digital display panel:
 Illuminated in accordance with the button depressing
 Battery life indicator..... The entire display begins flashing.

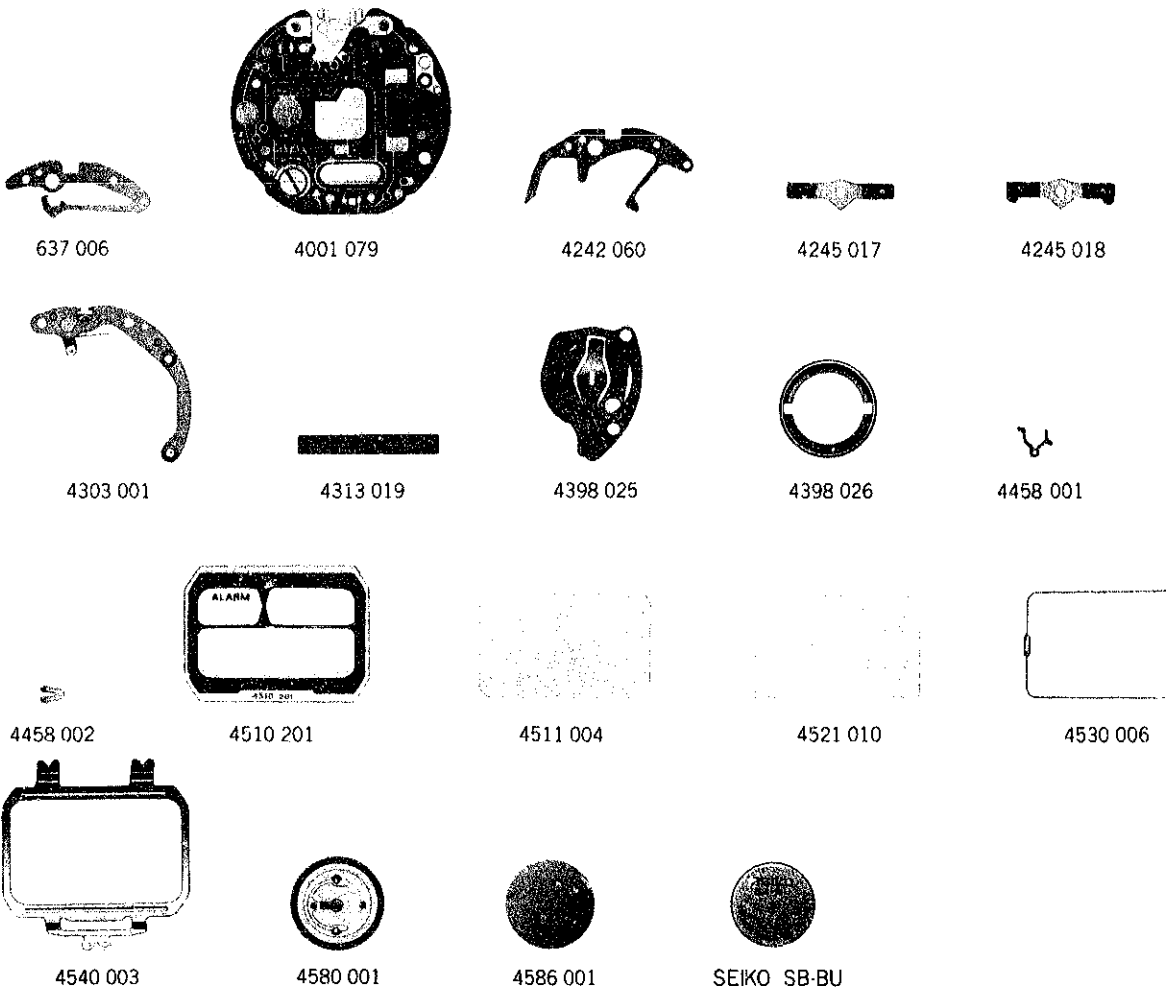

T	I	
012 455	013 281	2/1

Calibre No. A031A		Jewels 0j	Style Name QUARTZ LC ALARM	
PART NO.	PART NAME	PART NO.	PART NAME	
637 006	Contact point spring lever			
4001 079	Circuit block			
4242 060	Plus terminal of battery connection			
4245 017	Setting switch spring			
4245 018	Setting switch spring			
4303 001	Switch block			
4313 019	Connector			
4398 025	Battery guard			
4398 026	Speaker frame			
4458 001	Movement holding lever (A)			
4458 002	Movement holding lever (B)			
4458 002	Battery guard holding lever			
4510 201	Liquid crystal panel			
4511 004	Filter			
4521 010	Reflecting mirror			
4530 006	Bulb			
4540 003	Spring for liquid crystal panel			
4580 001	Speaker block			
4586 001	Sound diaphragm			
012 455	Switch block screw			
013 281	Bulb pin			
SEIKO SB-BU	Silver oxide battery			

TECHNICAL GUIDE

SEIKO DIGITAL QUARTZ

CAL. A031A

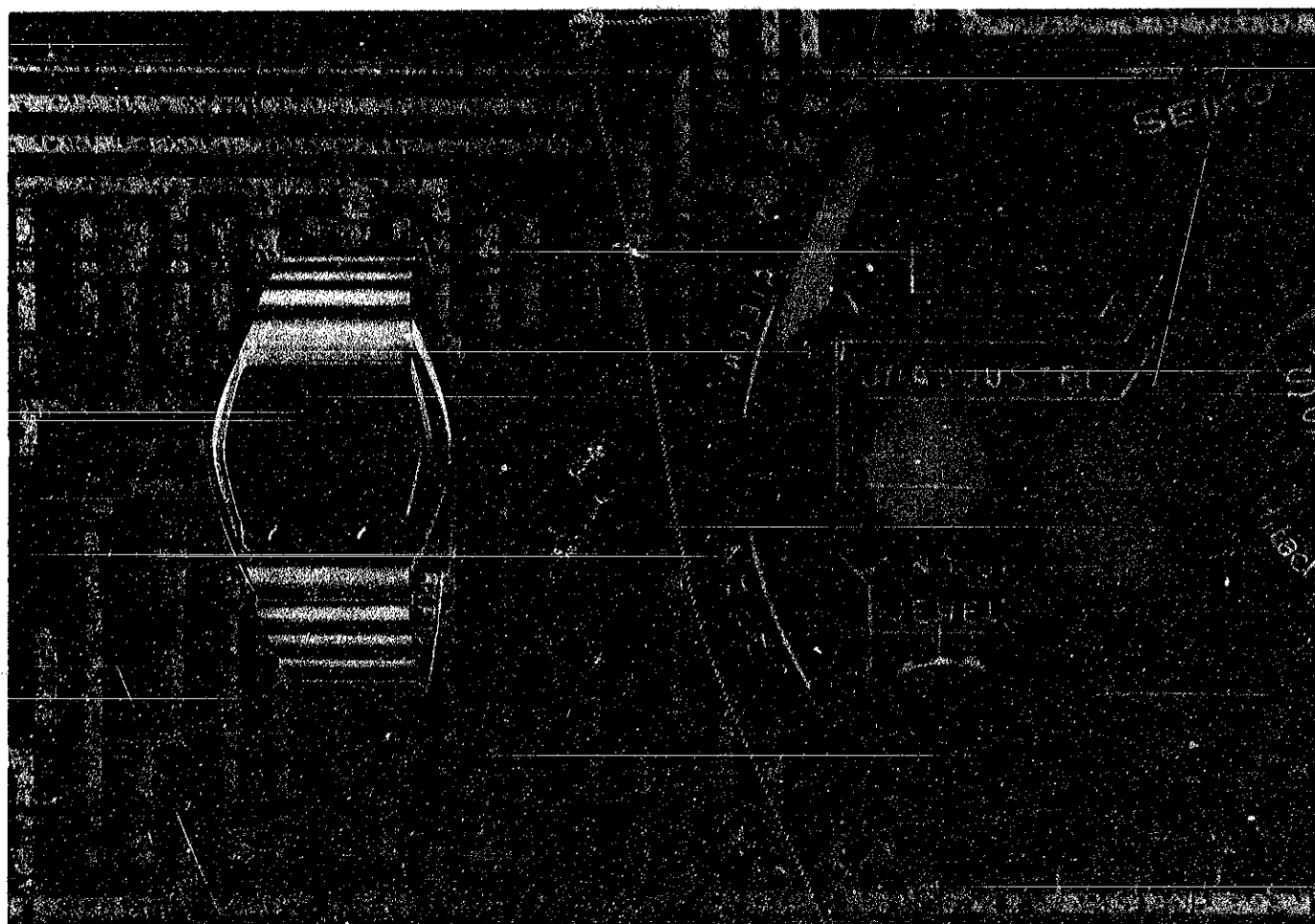

CONTENTS

I. SPECIFICATIONS AND FEATURES	1
1. Specifications	1
2. Features	1
II. BUTTON OPERATION AND FUNCTION CHANGEOVER	2
1. Function changeover	2
2. Display adjustment	2
3. Battery life indicator function	5
III. ALARM SOUNDING MECHANISM AND OUTLINE OF FUNCTIONING	6
1. Structure	6
2. Outline of functioning	6
IV. AFTER-SALE SERVICING INSTRUMENTS AND MATERIALS	7
V. CASE	10
VI. DISASSEMBLING, REASSEMBLING, LUBRICATING AND CLEANING	12
1. Liquid crystal panel side	12
2. Switch mechanism side	14
3. Cleaning	16
VII. CHECKING AND ADJUSTMENT	17
1. Guide table for checking and adjustment	17
2. Malfunction and checking points	18
3. Procedures for checking and adjustment	19
A. Check battery voltage	19
B. Check battery conductivity	19
C. Check conductivity of liquid crystal panel, circuit block and connector	20
D. Check switch components	21
E. Check circuit block and liquid crystal panel	22
F. Check current consumption	23
G. Check accuracy	24
H. Check alarm sounding condition	24
I. Check bulb condition	25
J. Check functioning	25
K. Check battery life indicator	26

I. SPECIFICATIONS AND FEATURES

Calibre A031A

Movement

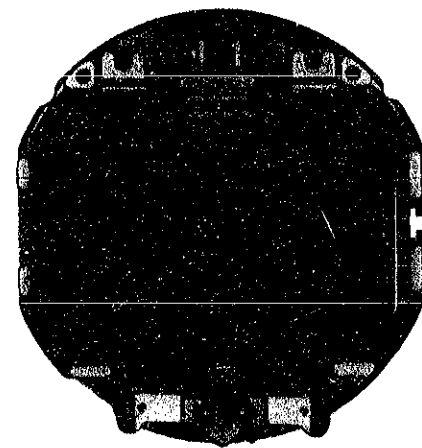

Display panel side

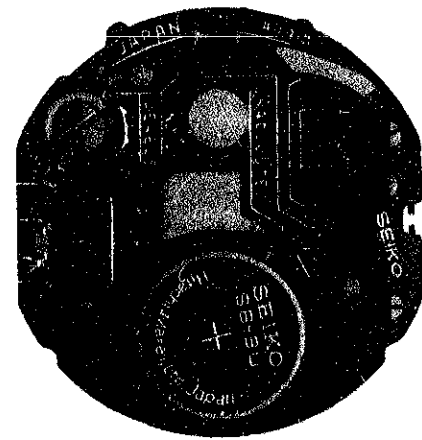

Case back side

1. Specifications

Item	Calibre No.	A031A
Display medium		Nematic Liquid Crystal, FEM (Field Effect Mode)
Display system		Time and calendar display Hour, minute and second: 24-hour Digital Display System Date: Automatic calendar system (The automatic calendar system automatically adjusts even and odd months except February.) • Date display or second display can be selected by simply depressing button "B". Alarm time display Hour & minute: 24-hour Digital Display System
Additional mechanism		Battery life indicator Alarm (Crystal sound system) • Starts sounding at the required alarm time (once for 20 seconds at a time) • Starts sounding every hour, when both the minute digits and the second digits indicate "00". (If the date digits are displayed, the alarm does not operate.) Illuminating light
Crystal oscillator		32,768 Hz (Hz = Hertz . . . Cycle per second)
Loss/gain		Loss/gain at normal temperature range Mean monthly rate: less than 15 seconds (Annual rate: less than 3 minutes)
Casing diameter		φ28.4 mm (27.0 mm between 3 o'clock and 9 o'clock sides)
Height		6.7 mm
Operational temperature range		-10°C ~ +60°C (14°F ~ 140°F)
Regulation system		Trimmer condenser
Battery power		SEIKO SB-BU silver oxide battery Battery life is approximately 2 years. (If the light is used 5 times a day and the alarm is used once a day.)
IC (Integrated circuit)		C-MOS-IC (Complementary Metal Oxide Silicon Integrated Circuit). 1 piece Bipolar-IC 1 piece

2. Features

In addition to displaying hour, minute, second and calendar digits, the SEIKO Digital Quartz Cal. A031A with its crystal sound system is capable of sounding a clear alarm every hour on the hour and at the required alarm time that can be set up to the minute.

II. BUTTON OPERATION AND FUNCTION CHANGEOVER

1. Function changeover

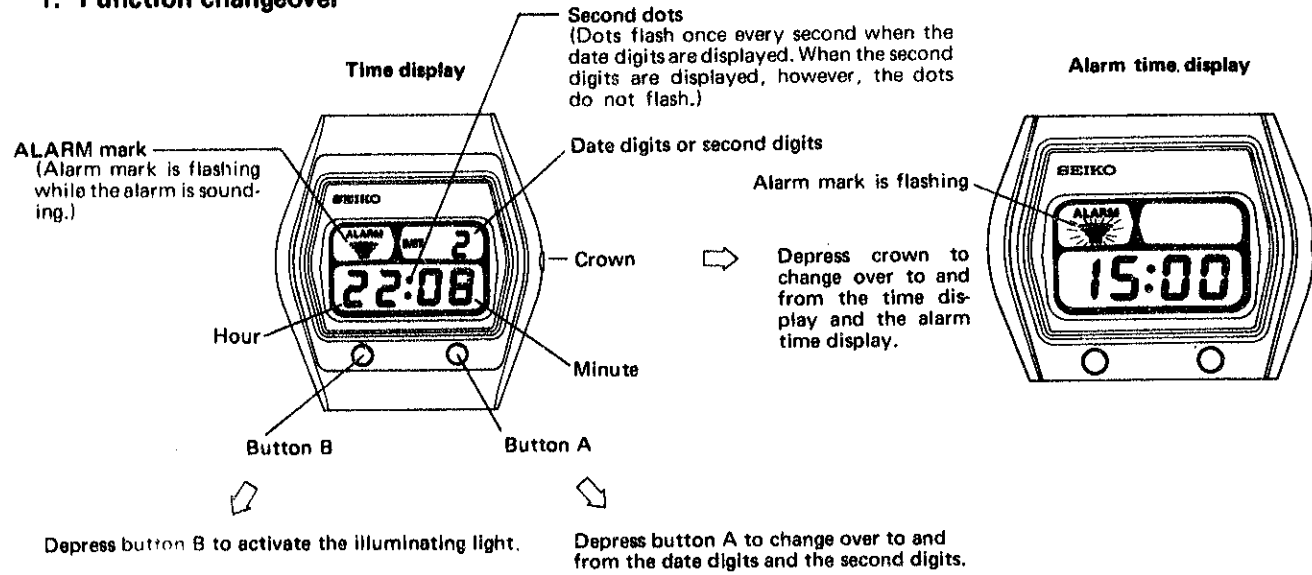

NOTE:

- Other button operation
 - Depress button "B" to stop the alarm sounding when the alarm is sounding at the required alarm time.
 - Depress buttons "A" and "B" at the same time to start the alarm sounding.
- Alarm
 - Starts sounding at the required alarm time. (Once a day for 20 seconds)
 - Starts sounding every hour. (When both the minute digits and the second digits indicate "00".) (If the date digits are displayed, the alarm does not sound.)

2. Display adjustment

[Procedures for display adjustment]

1) Display selection

Pull out crown to make displays ready to be adjusted. With the time digits being displayed, pull out crown to make the time digits ready to be adjusted. With the alarm time digits being displayed, pull out crown to make the alarm time digits ready to be adjusted.

Time digits being displayed

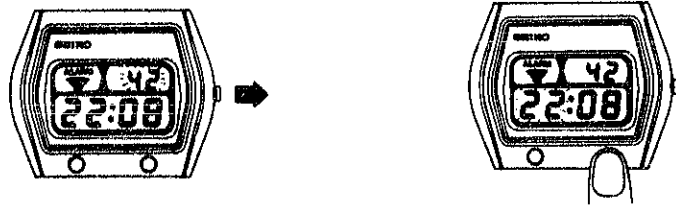

Pull out crown.
(If the date digits are displayed, they will be changed automatically into the second digits by pulling out crown.)

Depress button "A"
Each depression of button "A" will select the digits (flashing) to be adjusted in the following order.
Second → Hour → 10-minute → 1-minute → Month → Date

Alarm time being displayed



Pull out crown.

Depress button "A"

Each depression of button "A" will select the digits (flashing) to be adjusted in the following order.
Hour → 10-minute → 1-minute

2) Display adjustment



After selecting the digits to be adjusted, depress button "B". One digit is advanced by each depression of button "B".

[Example]

- How to adjust the time & calendar digits
(All the digits should be adjusted with crown in the pulled-out position.)

HOW TO SET THE SECOND

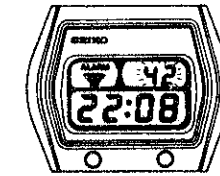

Pull out crown to start the second digits flashing. (Even if the date digits are displayed, they will be changed automatically into the second digits by pulling out crown.)

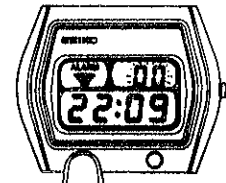

Depress button "B" to reset the second digits to "00" second.

(When the second counts any numbers from "00" to "29", the second is automatically reset to "00" and starts immediately whenever button "B" is depressed. If, however, the second counts from "30" to "59" when button "B" is depressed, one minute is added and the seconds return to "00".)

HOW TO SET THE HOUR

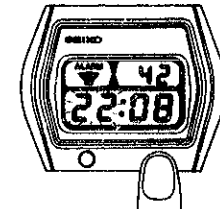

Depress button "A" to start the hour digits flashing.

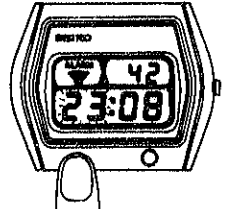

One hour is advanced by each depression of button "B".

HOW TO SET THE MINUTE

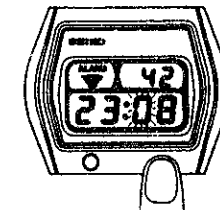

Depress button "A" to start the 10-minute digit flashing.

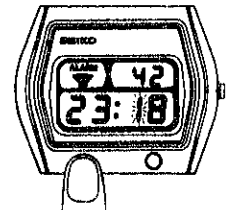

Ten minutes are advanced by each depression of button "B".

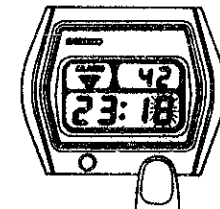

Depress button "A" to start the 1-minute digit flashing.

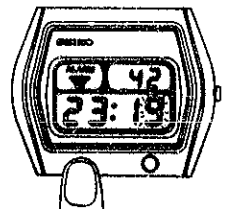

One minute is advanced by each depression of button "B".

HOW TO SET THE MONTH

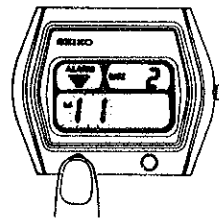
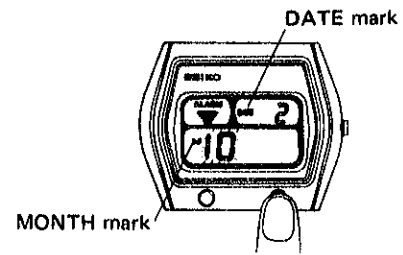

Depress button "A" to display the month digits and the date digits. Only the month digits start flashing.

One month is advanced by each depressing of button "B".

HOW TO SET THE DATE

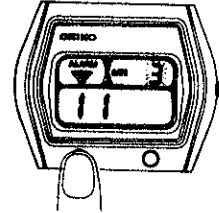
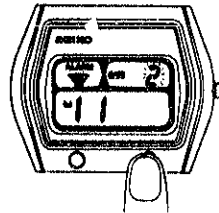

Depress button "A" to start the date digits flashing.

One date is advanced by each depression of button "B".

AFTER THE TIME AND CALENDAR ADJUSTMENT ARE COMPLETED.

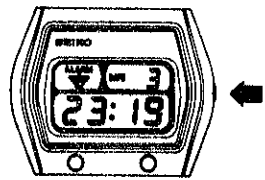

Push in crown to the normal position.

How to set the alarm time

DISPLAY THE ALARM TIME



Depress crown to display the alarm time. ("ALARM" mark starts flashing.)



Pull out crown to make display ready to be adjusted.

HOW TO SET THE HOUR

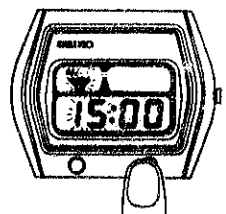

Depress button "A" to start the hour digits flashing.

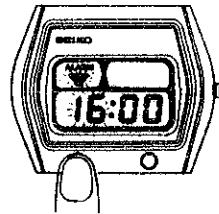

One hour is advanced by each depression of button "B".

HOW TO SET THE MINUTE

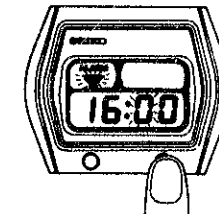

Depress button "A" to start the 10-minute digit flashing.

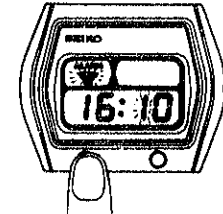

Ten minutes are advanced by each depression of button "B".

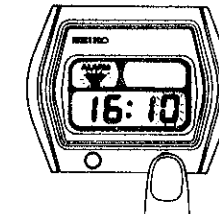

Depress button "A" to start the 1-minute digit flashing.

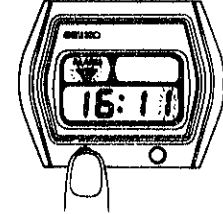

One minute is advanced by each depression of button "B".

AFTER THE ALARM TIME SETTING IS COMPLETED.

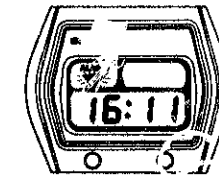

Push in crown to the normal position.

WHEN THE ALARM TIME IS NOT REQUIRED.

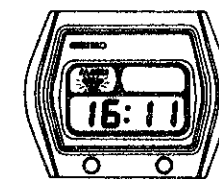

Pull out crown.

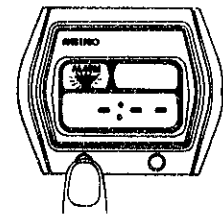

Depress button "B" to release the alarm time.

3. BATTERY LIFE INDICATOR FUNCTION

The battery needs to be replaced when you see the entire display flashing every second. The battery will expire in about one week from that time. The watch will, however, remain accurate while flashing.

[REMARKS FOR BATTERY CHANGE]

Incomplete, erroneous or flashing digital display may be indicated on the display panel after the battery is replaced. However, this is not a malfunction. Correct digital display will be indicated on the display panel by adjusting the time and the alarm time displays using the preceding instructions. If the digital display does not stop flashing after the battery is replaced, set the time digits before 9:04:00 and wait until the time digits pass the 9:05:00. After the digital display stops flashing, set the desired time.

III. ALARM SOUNDING MECHANISM AND OUTLINE OF FUNCTIONING

1. Structure

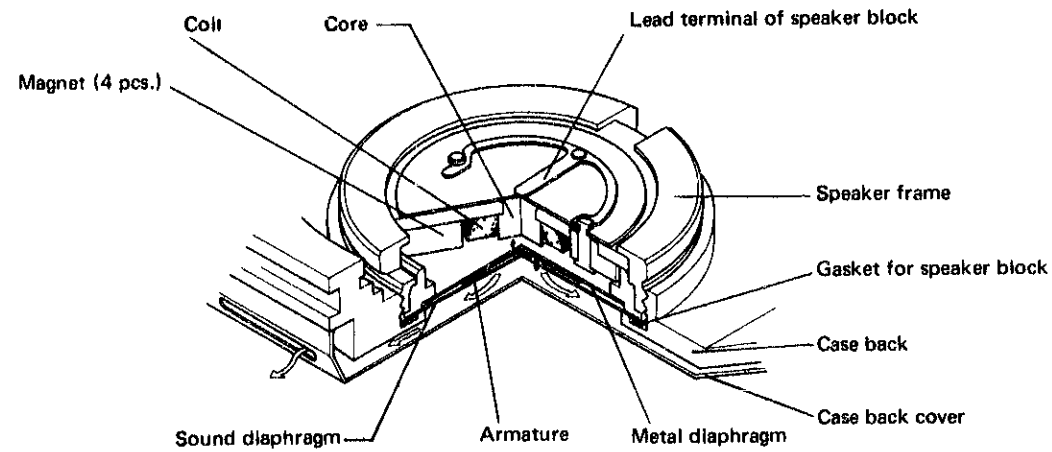

The speaker used in the SEIKO Digital Quartz Cal. A031A has been specially developed for SEIKO alarm watches and is excellent in durability, shock and humidity. Also, the speaker is so designed that it gives sufficient volume of sound with the lowest possible consumption of current.

2. Outline of functioning

The register circuit, the coincidence circuit and the speaker driving circuit are specially designed for the alarm operation.

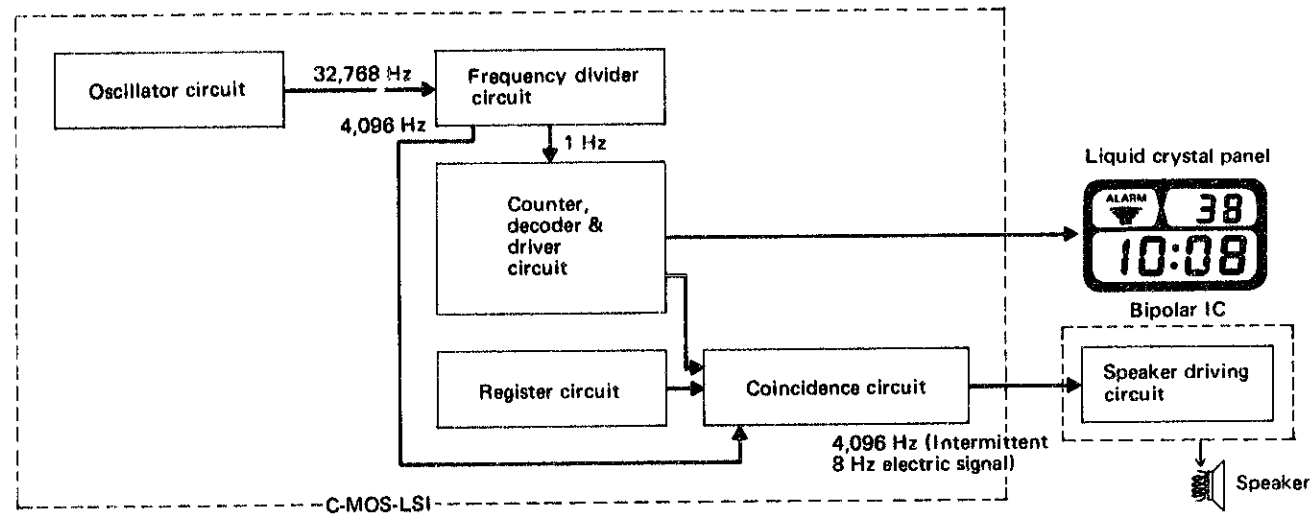

- (1) The register circuit memorizes the alarm time.
- (2) The coincidence circuit checks the displayed time on the liquid crystal panel with the alarm time memorized by the register circuit. When the two times coincide, the coincidence circuit sends a signal to the speaker driving circuit and orders it to operate the alarm. This is the electric signal that is converted into an intermittent 8 Hz electric signal from a 4,096 Hz electric signal, which is taken out of the frequency divider circuit.
- (3) The speaker driving circuit amplifies the electric signal received from the coincidence circuit into such signal that is most suitable for operating the speaker.
- (4) When the speaker coil receives the electric signal, the coil becomes magnetized and vibrates the armature.
- (5) The vibration of the armature (metal diaphragm) causes the sound diaphragm to be resonant and produce the alarm sound.

IV. AFTER-SALE SERVICING INSTRUMENTS AND MATERIALS

For after-sale servicing of SEIKO Quartz Digital Cal. A031A, the following after-sale servicing instruments and materials are necessary.

1. Quartz Tester
Used to check time accuracy.

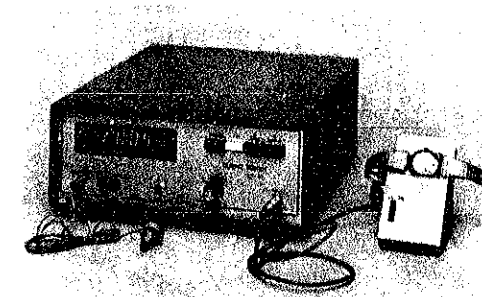

4. Movement holder (S-644)
Used for disassembling and reassembling of the movement.

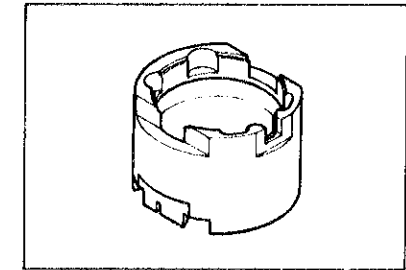

2. Volt-ohm-meter
Used to check the battery voltage and its conductivity and to measure the current consumption.

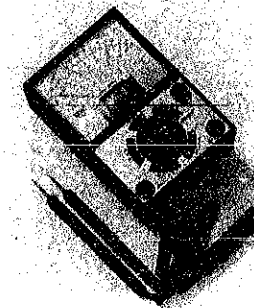

5. Battery holding spring (S-813)
Used for securing battery and flowing current when the movement is removed from the case.

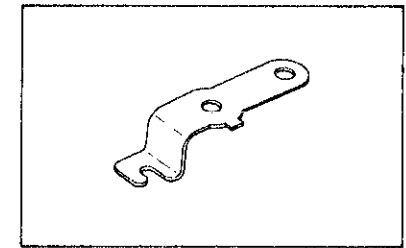

3. Micro-test MT-10 II
Used to check the current consumption and supplies a constant flow of voltage power.

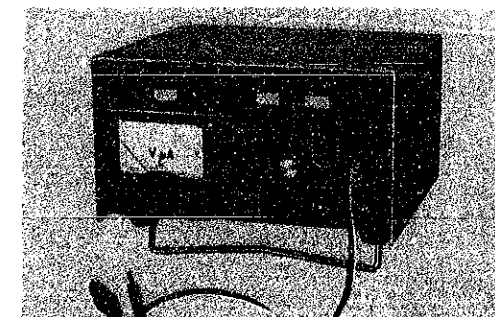

6. Static electricity protector (S-830)
Used to protect the circuit block from being damaged by static electricity.

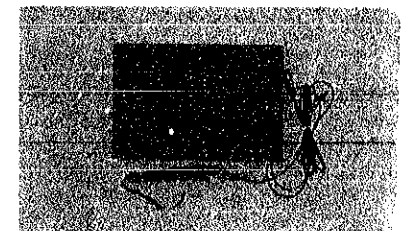

7. Speaker frame opener (S-822A)
Used for disassembling and reassembling of the speaker block in the case back.

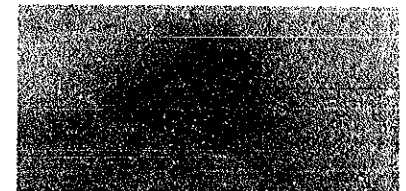

HOW TO USE QUARTZ TESTER QT-77

K. Hattori & Co., Ltd. has put on sale its new Quartz Tester QT-77. When measuring the watch accuracy by the new Quartz Tester QT-77, be sure to follow the instructions below.

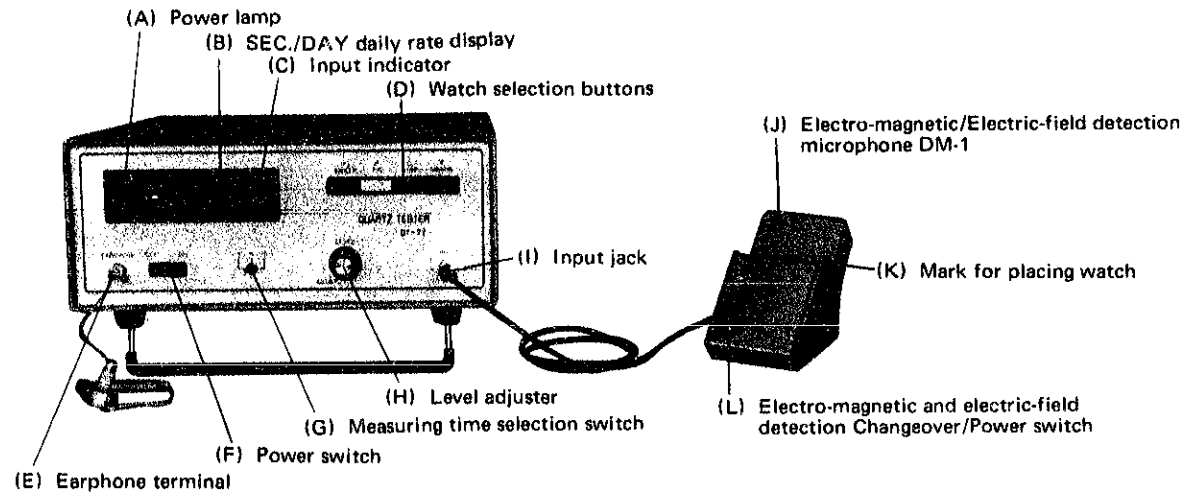

Preparations before measurement

- Make sure that the voltage indicated by the supply voltage setting switch is the same as the voltage rating of your household power supply. If it isn't, turn the fuse holder counterclockwise (arrow-marked direction) and remove the fuse. Pull out the supply voltage setting switch and adjust it to the voltage rating of your power supply, and set the fuse in position.

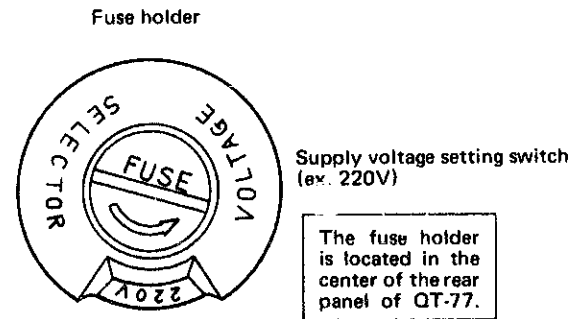

• Battery for Electro-magnetic/electric-field detection microphone DM-1

If the microphone is to be used for the first time, insert the battery (supplied along with the microphone) into the microphone. It is recommended to check the battery voltage periodically. When the microphone is not used turn the electro-magnetic and electric-field detection Changeover/Power switch to "STEP, SWEEP, LE" side, to preserve the battery life.

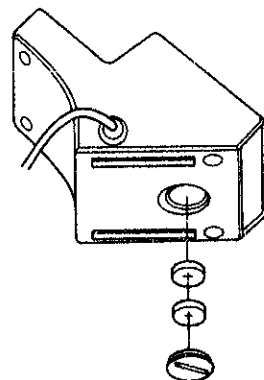

Measurement of time accuracy (daily rate)

- (1) With the power switch (F) off, insert the power supply cord plug into the electric power outlet. Leave the Quartz Tester (QT-77) to stand for some 20 minutes.
- (2) Turn on the power switch (F). The power lamp (A) will light up.
- (3) Put the plug of the electro-magnetic/electric-field detection microphone DM-1 (J) all the way into the input jack (1).
- (4) Depress white button (LC) of the watch selection button.

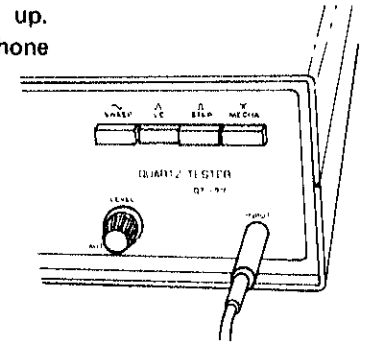

- (5) Set the measuring time selection switch (G) at "4 sec.", "6 sec." or "10 sec.". The daily rate can be measured at any position 4 sec., 6 sec. or 10 sec. It is generally accepted, however, that the longer the measuring time is the more accurate will be the measurement.
- (6) Insert the earphone cord plug into earphone terminal (E).
- (7) Turn the level adjuster (H) to AUTO position (turn it counterclockwise until a click is heard).
- (8) Push the switch (L) of the microphone (J) to the LC-ON position (electric-field detection function).
- (9) Place the watch on the microphone.

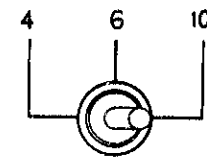

Place the watch with its liquid crystal display facing the mark (K) in the center of the microphone. Put on the earphone, and move the watch on the microphone in various ways, and by changing its position and angle, the volume will change. Determine the watch position and direction where the earphone sound becomes loudest. At this time, the input indicator (C) will remain lit.

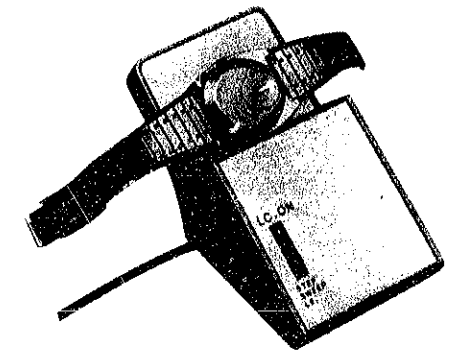

Note:

In almost all cases, all the above procedure will be sufficient for measuring the daily rate. If the input indicator flashes or does not light up at all, turn the level adjuster to keep the input indicator lit during measurement.

- (10) Read the daily rate on the display panel (B). If the daily rate of the watch exceeds the measurable range, it is not displayed on the panel.

Note:

If the glass of the watch has perspiration or oil on it, the Quartz Tester QT-77 does not pick up the signal. Be sure not to put the watch in a vinyl bag while it is being measured.

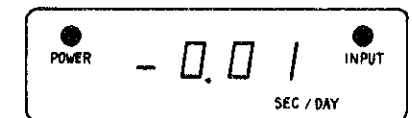

V. CASE

Disassembling procedures Figs.: ① ~ ⑫

Reassembling procedures Figs.: ⑫ ~ ①

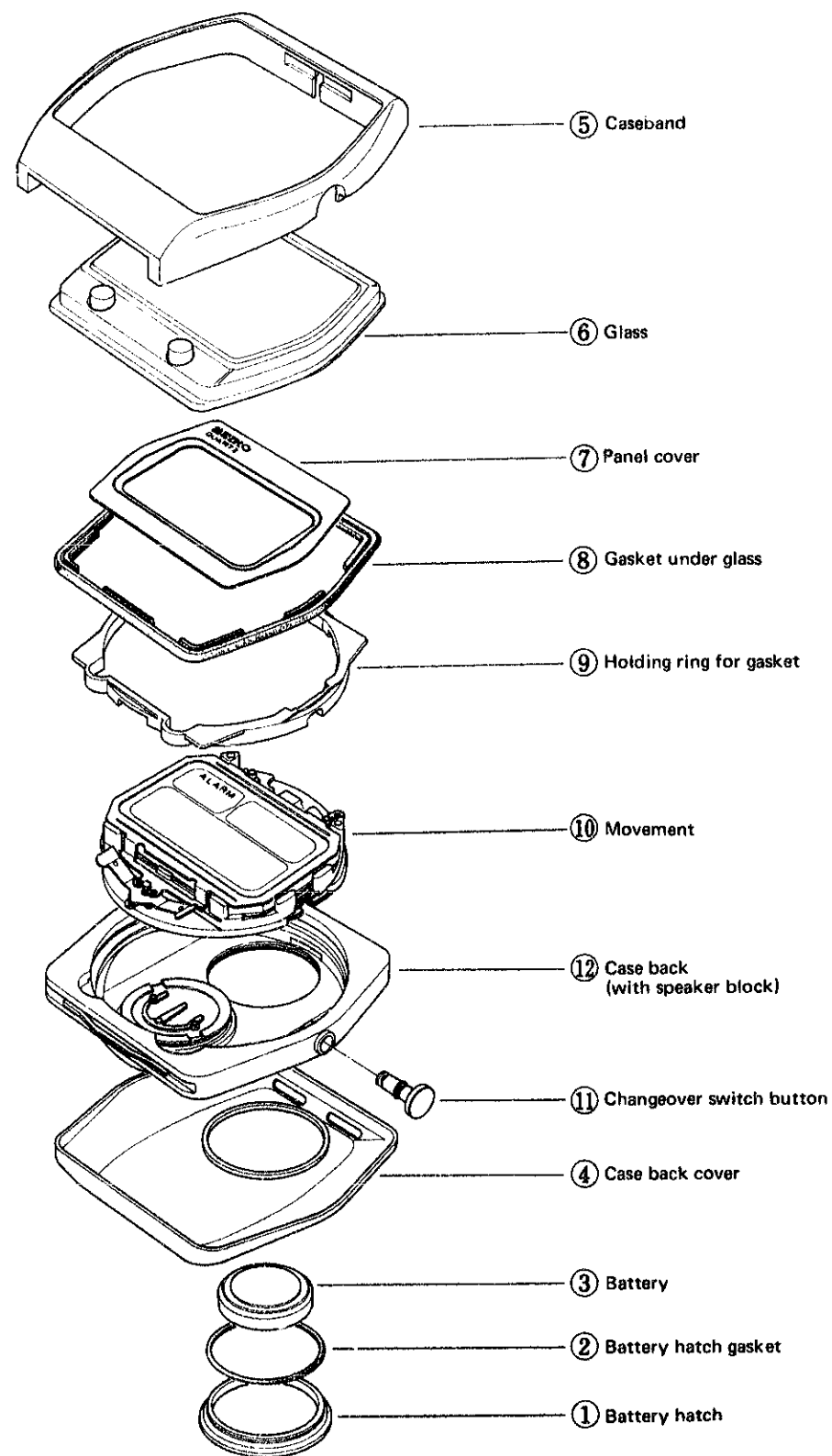

Remarks for disassembling and reassembling

① Battery hatch

As the case back cover is secured by the battery hatch, remove the battery hatch first when the watch is disassembled.

⑥ Glass

Before reassembling the glass, wipe off dust and lint around the time adjusting buttons. (Disassemble the hook-ups for the time adjusting buttons ("C" clamps) first and then the time adjusting buttons before removing dust and lint.)

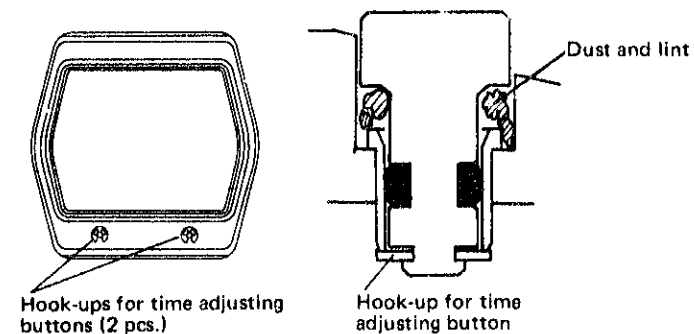

⑩ Movement

• Disassembling

Turn the movement holding levers "A" and "B" in the arrow-marked direction to disassemble the movement.

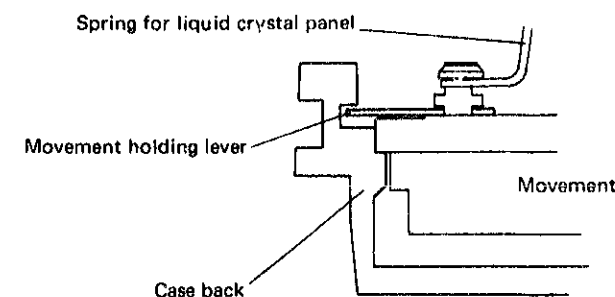
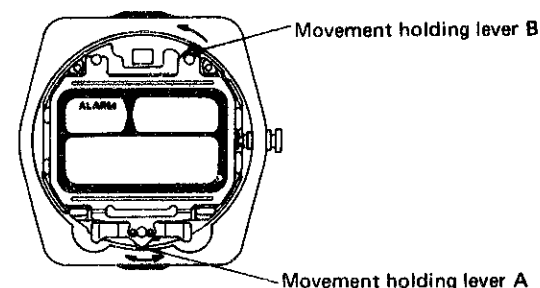

• Reassembling

- Hook the switch lever of the switch block to the groove of the changeover switch crown.
- Turn the movement holding levers "A" and "B" in the arrow-marked direction to reassemble the movement.

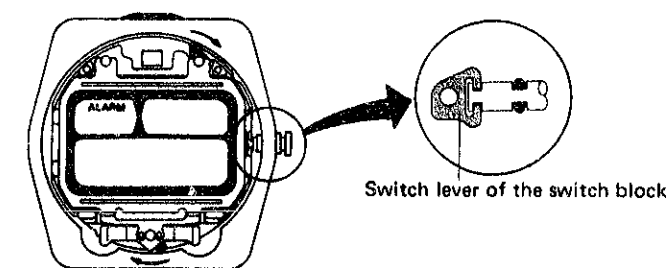

⑫ Case back

How to disassemble the speaker block

Do not disassemble the speaker block except when replacement of parts or repair is necessary.

Use speaker frame opener (S-822A) for the disassembling of the speaker frame (screw ring).

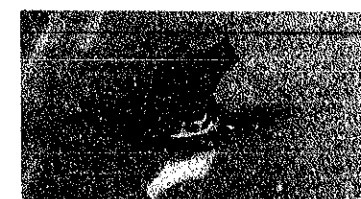
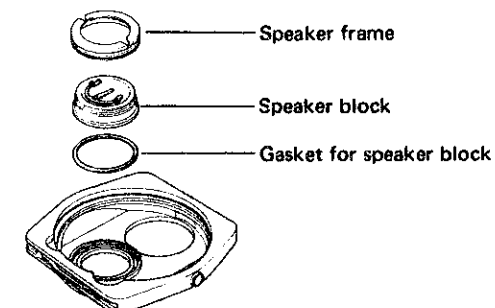

• How to disassemble the sound diaphragm of the speaker block

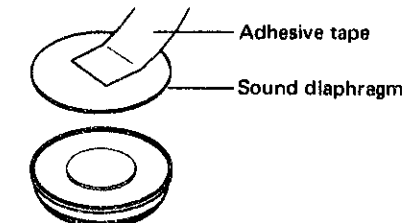

Do not disassemble the sound diaphragm of the speaker block except when replacement of the sound diaphragm is necessary.

VI. DISASSEMBLING, REASSEMBLING, LUBRICATING AND CLEANING

Disassembling procedures Figs.: ① → ⑱

Reassembling procedures Figs.: ⑱ → ①

Lubricating  : SEIKO Watch Oil S-6, normal quantity

1. Liquid crystal panel side

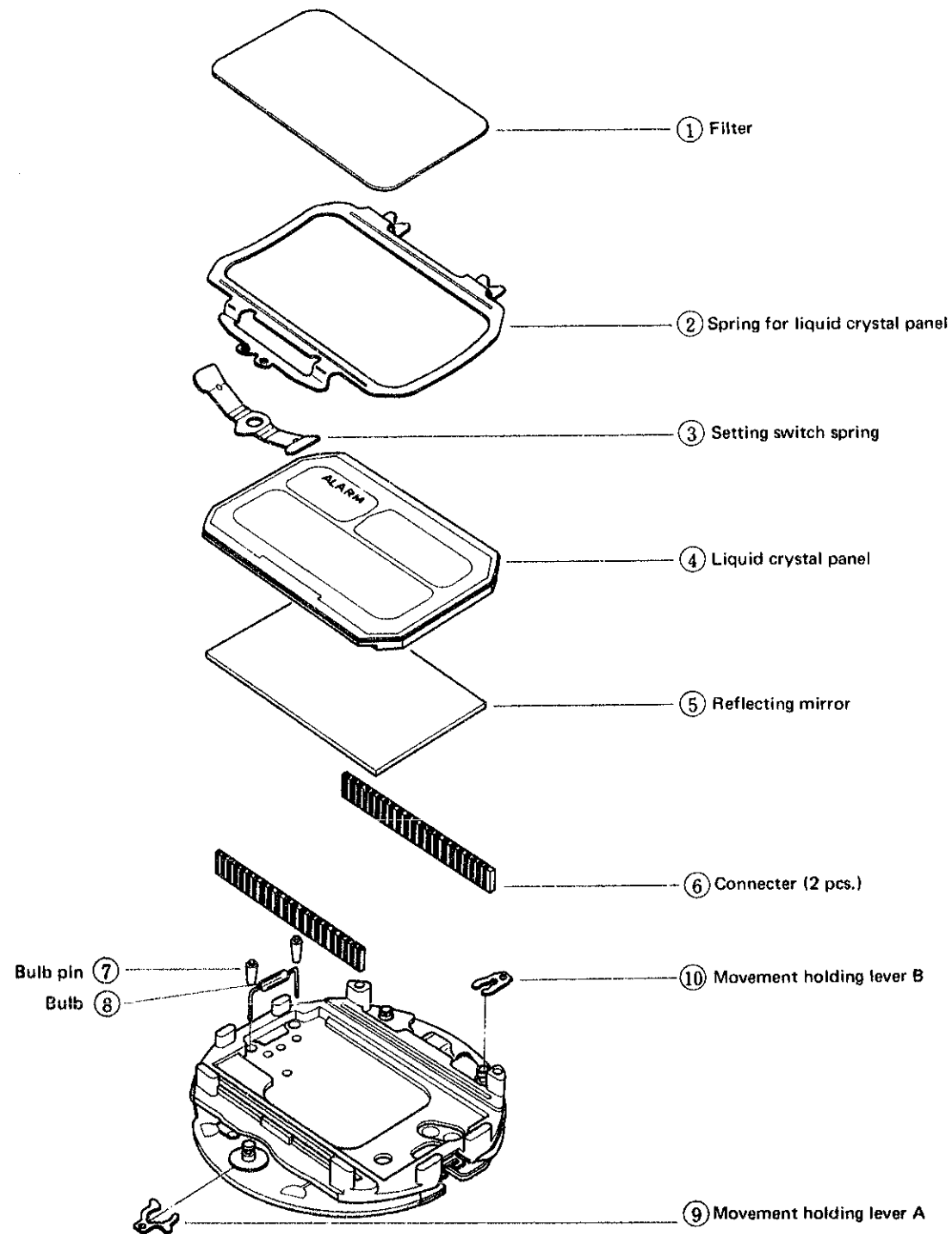

Remarks for disassembling and reassembling

② Spring for liquid crystal panel

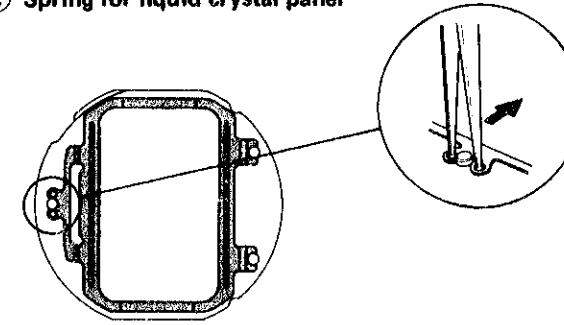

Insert the tips of the tweezers into the two holes of the spring for liquid crystal panel and pry it up in the arrow-marked direction for disassembling.

③ Setting switch spring

There are two different types of setting switch spring.

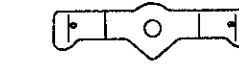

Setting switch spring for the square-type case



Setting switch spring for the round-type case

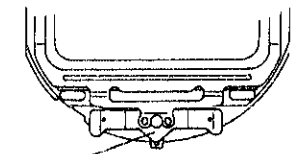

The triangular extended portion must face the outside of the movement.

④ Liquid crystal panel

Use fingercots to disassemble and reassemble the liquid crystal panel.

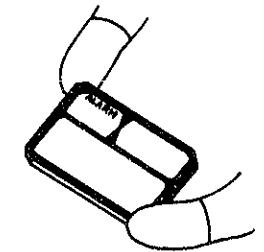

⑥ Connector

Although two connectors are used, there is no difference between the two. The black portions are conductive. Check to see if there are any scratches or contamination.

⑧ Bulb

Do not disassemble the bulb from the circuit block except when it is replaced with a new one. When replacing the bulb, set it as shown in the illustration on the left below.

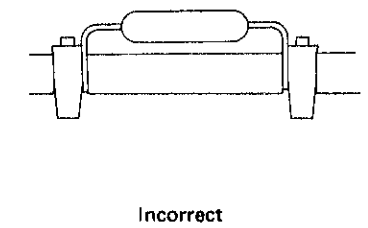
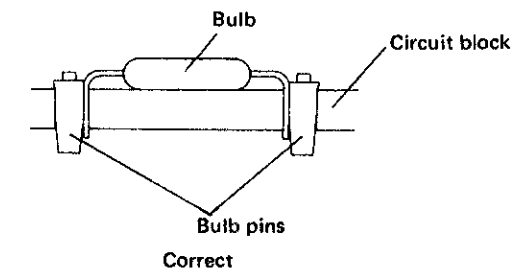

⑨, ⑩ Movement holding lever A and B

The movement holding lever "A" and "B" have different shapes. Be careful not to mistake "A" and "B" for each other.



Movement holding lever A



Movement holding lever B

2. Switch mechanism side

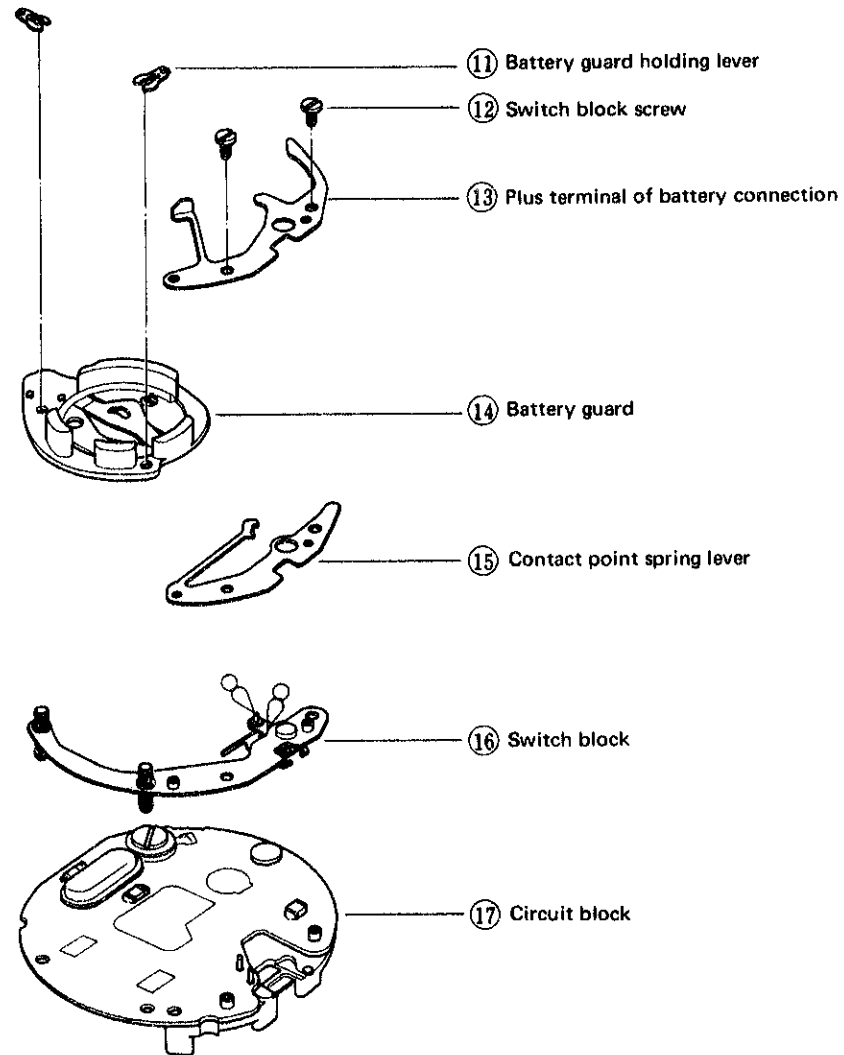

Remarks for disassembling and reassembling

⑪ **Battery guard holding lever**
 The battery guard holding lever is the same as the movement holding lever "B".
 Move the battery guard holding lever in the arrow-marked directions for disassembling and reassembling.

⑫ **Switch block**
 Reassemble the contact point spring of the switch block in between the two pins (the unlock switch pin and the display switch pin) of the circuit block.

• Function of the switch block (contact point spring)

• Switch lever in the normal position (crown in the normal position).

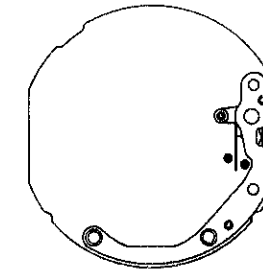

The contact point spring touches neither the unlock switch pin nor the display switch pin.

• Switch lever in the pulled out position (crown in the pulled out position).

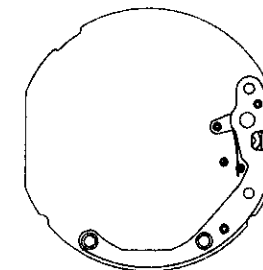

The contact point spring touches the unlock switch pin and this makes it possible for the display to be adjusted. (When the time digits are being displayed, the second digits are ready to be adjusted.)

➡ Pull out

• Switch lever in a pushed in position (crown in a pushed in position).

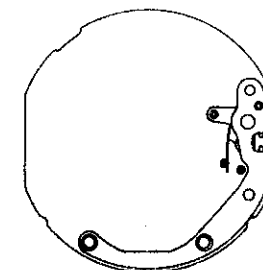

The contact point spring touches the display switch pin and this enables the changeover to and from the time display and the alarm display.

⬅ Depress

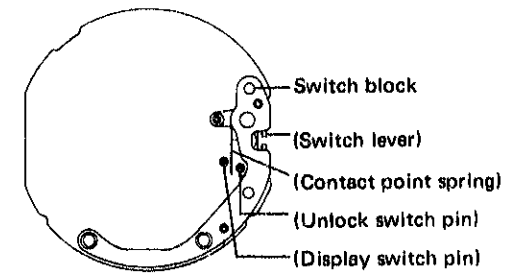
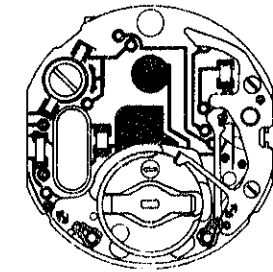

3. Cleaning

1) HOW TO CLEAN

Name of parts	Cleaning	Drying	Solution	Remarks
Connector 	Rinse or clean with a soft brush	Cool air	Alcohol	<ul style="list-style-type: none"> • Clean the connected portion of the connector to the liquid crystal panel and the circuit block.
Plastic parts	Rinse or clean with a soft brush	Cool air	Benzine or alcohol	
Other parts (excluding the parts that must not be cleaned.)	Rinse or clean with a brush	Cool or hot air	Benzine, trichloroethylene or alcohol	<ul style="list-style-type: none"> • When cleaning the switch block, be careful not to bend the thin spring.

2) PARTS THAT MUST NOT BE CLEANED

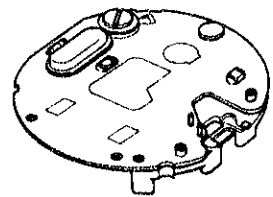

Circuit block



Liquid crystal panel

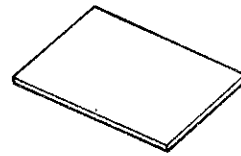

Reflecting mirror



Filter



Bulb



Speaker block

- Only the conductive portions should be wiped with a cloth moistened with benzine or alcohol and dried with cool air.
- Use a brush to clean dust and lint off.

VII. CHECKING AND ADJUSTMENT

1. Guide table for checking and adjustment

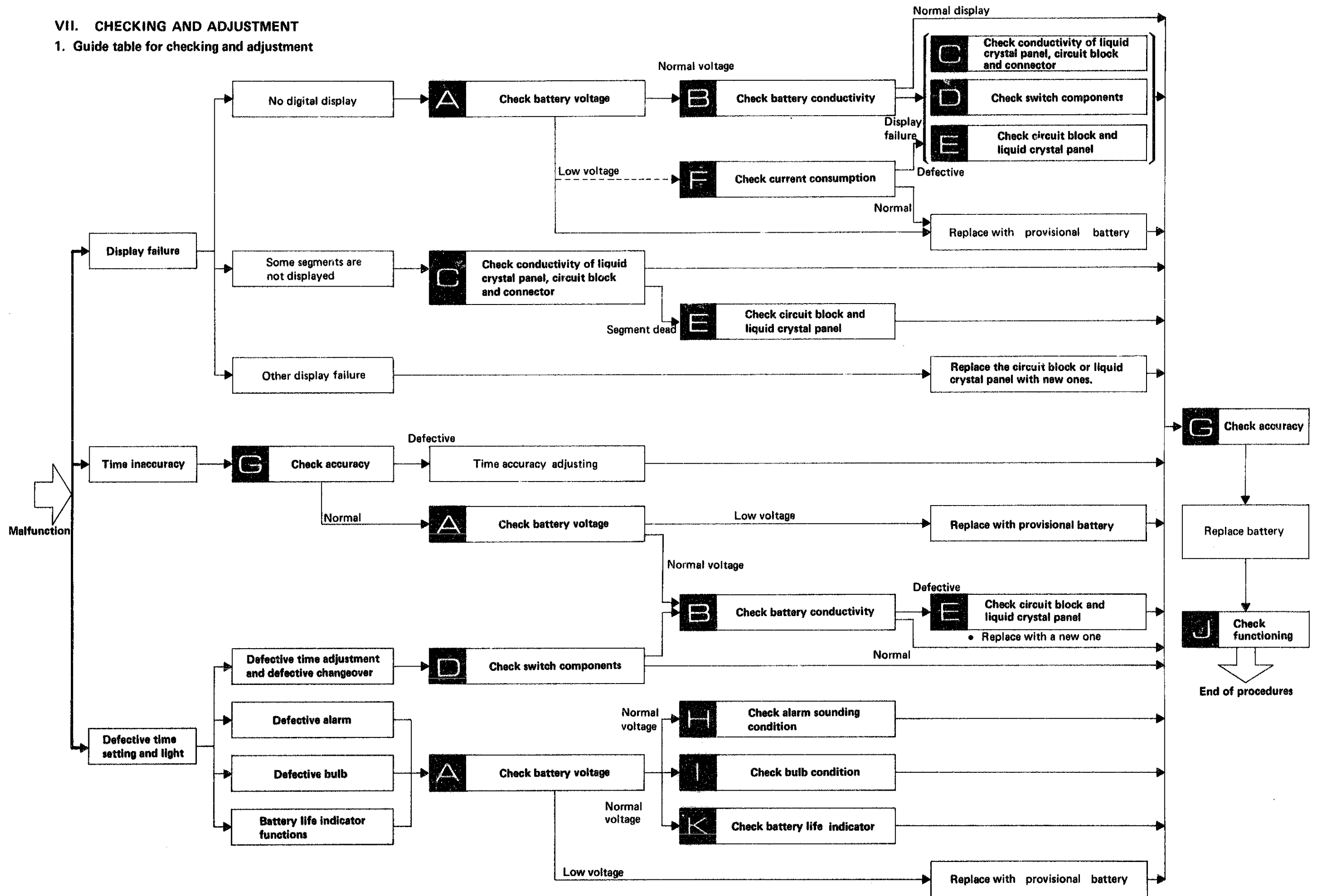





Note:

- If it is difficult to locate the malfunctioning portion, proceed to **J Check functioning** first.

2. Malfunction and checking points



- Check in numerical order.
- Refer to "Procedures for checking and adjustment" on the following pages.

FAULTY SYMPTOMS		CHECKING POINTS								
		A	B	C		D	E	H	I	K
		Battery voltage	Battery conductivity	Liquid crystal panel	Circuit block	Connector	Switch components	Circuit block, Liquid crystal panel	Alarm sounding condition	Bulb condition
DISPLAY FAILURE	Stop (Though the digits are displayed, digital figures do not change).	①	②				③	④		
	No digital display, dim digital display or extremely slow response. [Example] 	①	②	③	⑤	④		⑥		
	Some segments of the digital figures are not lighted or dim. [Example] 			②	③	①		④		
	All segments are displayed or the segments which should be on and off are reversed as shown in the illustration. [Example] 			②	③	①				
	Some portions of the liquid crystal panel will make black dots or appear iridescent. [Example] 			①						
TIME INACCURACY	Gain or loss tested by the Quartz Tester.	①	②							
	Though Quartz Tester indicates the normal figures, a watch gains or loses when it is worn on the wrist.	①	②		③			④		
DEFECTIVE TIME SETTING OR LIGHT	Light is not lit or light is lit but dims soon.	①							②	
	Alarm does not sound.	①			③			②		
	Display adjustment is impossible, or the display is extinguished while it is being adjusted.						①	②		
	All digital figures are flashing.	①								②

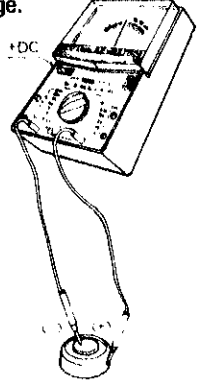
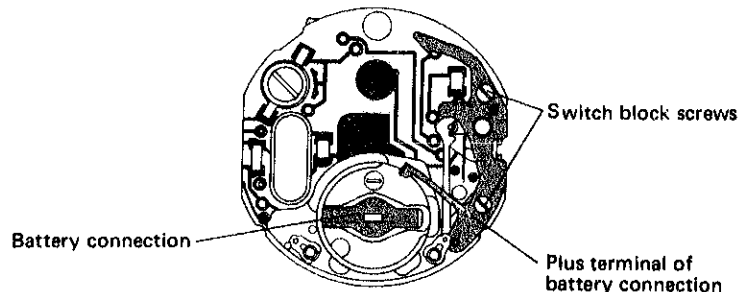
3. Procedures for checking and adjustment

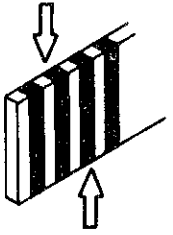
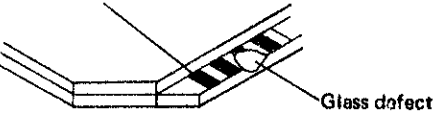
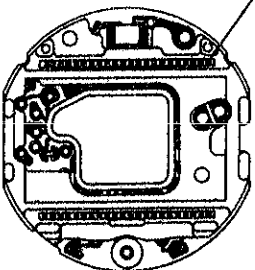
	Procedure	Result
<p style="writing-mode: vertical-rl; transform: rotate(180deg);">CHECK BATTERY VOLTAGE</p>	<p>Use the following procedures to check battery voltage.</p> <ul style="list-style-type: none"> • Set up the volt-ohm-meter <ul style="list-style-type: none"> Range to be used: DC 3 V • Measuring <ul style="list-style-type: none"> Probe Red (+) Battery surface (+) Probe Black (-) Battery surface (-) 	<p>More than 1.5 V → Normal Less than 1.5 V → Defective Replace battery with a new one.</p>
<p style="writing-mode: vertical-rl; transform: rotate(180deg);">CHECK BATTERY CONDUCTIVITY</p>	<p>First check Check for any contamination on the battery, battery connection and plus terminal of battery connection.</p> <p>Second check Make sure that the switch block screws are tightened firmly.</p>  <p>Third check Check to see if there is battery electrolyte leakage.</p> <ul style="list-style-type: none"> • How to repair battery electrolyte leakage <ol style="list-style-type: none"> 1. Remove the movement from the case. 2. Disassemble the movement. 3. Clean the parts contaminated with battery electrolyte. <ul style="list-style-type: none"> ▪ Clean the circuit block. <ol style="list-style-type: none"> (1) Wipe off battery electrolyte on the circuit block with a cloth moistened with distilled water (or normal water) first and then with a cloth moistened with alcohol. <p>NOTE:</p> <ul style="list-style-type: none"> ○ Do not use such fluffy cloth as gauze, flannel, etc. ○ Be careful that the trimmer condenser is not exposed to water or alcohol. <ol style="list-style-type: none"> (2) Dry with cool air by using a dryer. ▪ Clean the other parts. <ol style="list-style-type: none"> (1) Wipe off battery electrolyte on the other parts with a soft brush moistened with distilled water (or normal water) first and then rinse them with alcohol. (2) Dry with cool air by using a dryer. 4. Reassemble the movement Replace the battery with a new one. 5. Check to see if the time setting functions and the current consumption are normal. 	<p>Uncontaminated → Normal Contaminated → Defective Wipe off any foreign matter.</p> <p>No loosened screws → Normal Loosened screws → Defective Retighten screws.</p> <p>No battery electrolyte leakage → Normal Battery electrolyte leakage → Wipe off battery electrolyte by following the repairing procedure.</p>

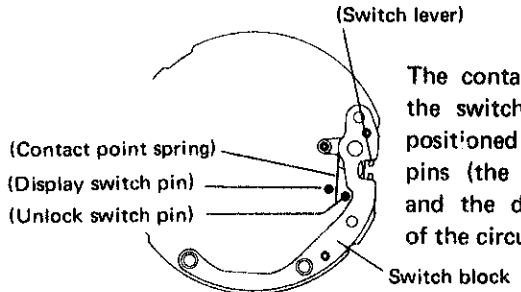
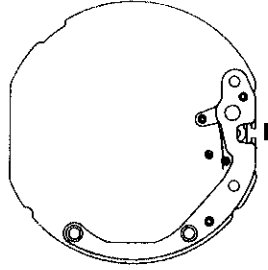
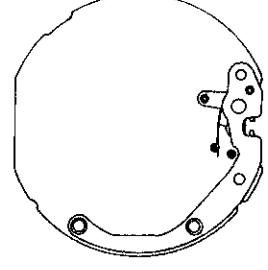
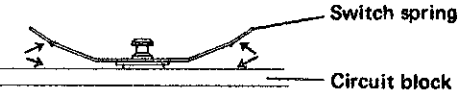
Procedure	Result
<p>First check Check for any contamination, crack and tiny break of the connector. Check carefully the connecting portions of the liquid crystal panel and the circuit block.</p> 	<p>No contamination, crack or tiny break → Normal Contaminated → Defective Wipe off any foreign matter. Crack or tiny break → Defective Replace the connector with a new one.</p>
<p>Second check Check the liquid crystal panel electrode (connecting portion of the connector for any foreign matter and glass defects).</p> <p>Liquid crystal panel electrode</p>  <p>Glass defect</p>	<p>Uncontaminated or no glass defect → Normal Contaminated → Defective Wipe off any foreign matter. Glass defect → Defective Replace the liquid crystal panel with a new one.</p>
<p>Third check Check the circuit block electrode (contacting portion of the connector) for any contamination.</p> <p>Circuit block electrode</p> 	<p>Uncontaminated → Normal Contaminated → Defective Wipe off any foreign matter.</p>

Procedure	Result
<p>First check</p> <ul style="list-style-type: none"> Check for any contamination on the contact point spring of the switch block, the unlock switch pin of the circuit block and the display switch pin. Check to see if the contact point spring of the switch block functions correctly. <p>Switch lever in the normal position</p>  <p>Switch lever in a pulled out position</p>  <p>Switch lever in a pushed in position</p>  <p>Second check Check for any contamination on the contact portions of the switch spring and the circuit block.</p> 	<p>Uncontaminated → Normal Contaminated → Defective Wipe off any foreign matter.</p> <p>Functions as shown in the illustration on the left → Normal Does not function as shown in the illustration on the left → Defective</p> <ul style="list-style-type: none"> The contact point spring is bent → Correct by using tweezers. The contact point spring is out of place as illustrated below → Reassemble it in the correct position.  <ul style="list-style-type: none"> The contact point spring is broken → Defective Replace the switch block with a new one. <p>Uncontaminated → Normal Contaminated → Defective Wipe off any foreign matter.</p>

First check

Check to see if the electric signal flows into the liquid crystal panel from the circuit block correctly.

- (1) Set the battery in the movement and hold by the battery holding spring.

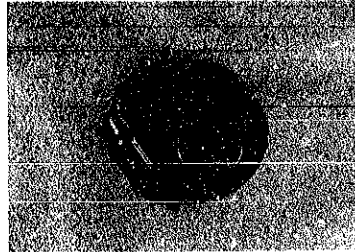

- (2) Disassemble the spring for liquid crystal panel, filter and liquid crystal panel by following the disassembling procedures.

- (3) Set up the volt-ohm-meter.
Range to be used: DC 3V

- (4) Measuring
Probe Red (+) . . . Pin on the circuit block (+) (Shown in the photo.)
Probe Black (-) . . . Black portions of the connector (Apply to several portions)

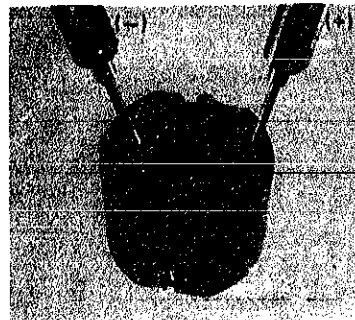

Note:
Touch the connector lightly with the probes.

More than 0.8 V → Normal
Less than 0.8 V → Defective
Replace the circuit block with a new one.

(The above voltage is obtained when measured by either the volt-ohm-meter AF-105 mentioned in the Technical Guide or a volt-ohm-meter whose internal resistance is higher than that of the AF-105.)

Procedure**Result****Second check**

Check the liquid crystal panel for any broken panel pattern short-circuit or other defects.

- (1) Set up the volt-ohm-meter
Range to be used: OHMS R × 1
(Any range will do if 3V is applied to the terminal of the volt-ohm-meter.)
- (2) Disassemble the liquid crystal panel from the movement and turn the liquid crystal panel upside down.
- (3) Measuring
Apply the red and black probes of the volt-ohm-meter to the common electrode of the liquid crystal panel and the segment electrode. (Either red or black probe will do.)

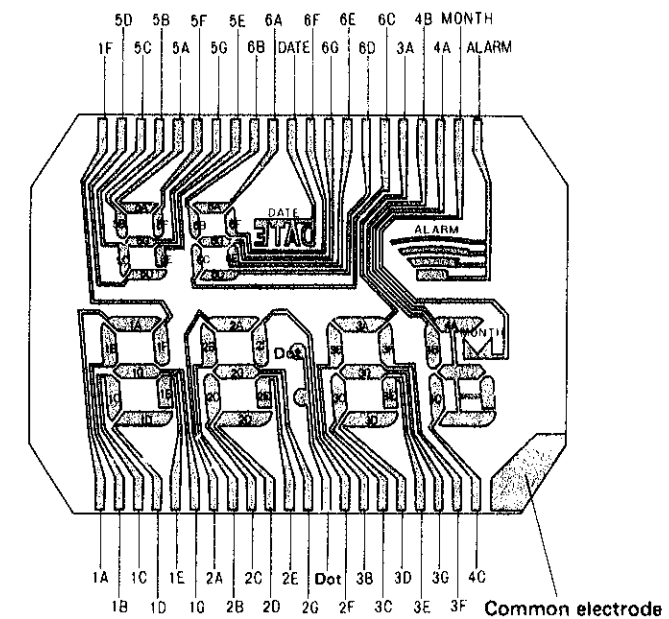



Lights up → Normal
Does not light up → Defective
Replace the liquid crystal panel with a new one.

Check to see if the current consumption is normal.

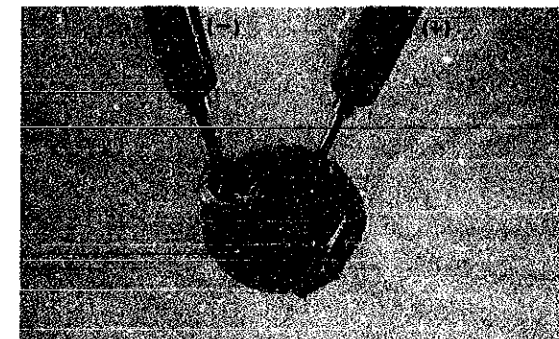
- (1) Set up the volt-ohm-meter
Range to be used: DC 0.03 mA
- (2) Place the battery on the plus terminal of battery connection with its (-) surface up.
- (3) Measuring
Probe Red (+) Battery connection
Probe Black (-) Battery surface (-)

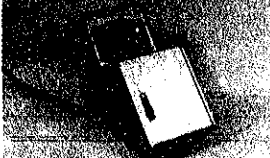
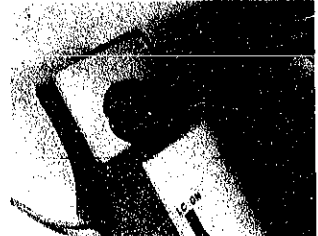

Less than 2.5 μ A → Normal
More than 2.5 μ A → Defective
Proceed to **B**, **C** and **D**.

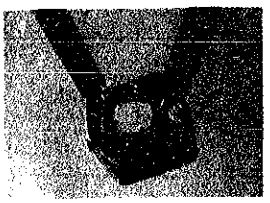
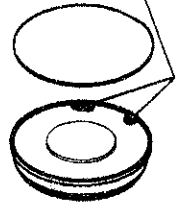
	Procedure	Result
CHECK ACCURACY	<p>Check gain and loss of time.</p> <ul style="list-style-type: none"> • Set up the Quartz Tester When the Quartz Tester QT-77 is used: (1) Set the microphone switch (Electro-magnetic and Electric-field detection Changeover-Power switch) to LC ON position. (2) Push the watch selection button (LC Button).  <ul style="list-style-type: none"> • How to adjust time accuracy The watch will gain or lose according to the direction in which the trimmer condenser is turned. Adjustment should therefore be made after ascertaining with the Quartz Tester whether the watch tends to gain or lose. Note for handling the trimmer condenser: Avoid excessive depressing and turning of the trimmer condenser. 	
CHECK ALARM SOUNDING CONDITION	<ul style="list-style-type: none"> • When the alarm does not sound First check Check the lead terminal of the speaker block and the lead pattern of the circuit block for any contamination and also check to see if the lead terminal of the speaker block is bent.  <ul style="list-style-type: none"> • Second check Measure the resistance of the coil in the speaker block and check for any broken coil wire or short-circuit of the speaker block. (1) Set up the volt-ohm-meter Range to be used: OHMS R X 1 (2) Measuring Apply red and black probes of the volt-ohm-meter to the speaker frame and the lead terminal of the speaker block. (Either red or black probe will do.)  <ul style="list-style-type: none"> • When the alarm sound is not clear. Third check Remove the sound diaphragm and check the speaker block for any contamination and also check if the sound diaphragm is bent. (See "Remarks for disassembling and reassembling" for the disassembling procedures of the sound diaphragm.) 	<p>Uncontaminated → Normal Contaminated → Defective Wipe off any foreign matter. Bent → Defective Correct by using tweezers.</p> <p>70 Ω ~ 90 Ω → Normal</p> <p>Less than 70 Ω (short-circuit) → Defective More than 90 Ω (broken coil wire) → Defective Replace the speaker block with a new one.</p> <p>Uncontaminated and not bent → Normal Contaminated → Defective Wipe off any foreign matter. Bent → Defective Replace the sound diaphragm with a new one.</p>

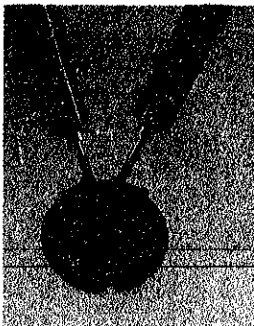
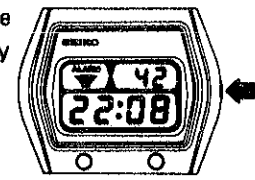
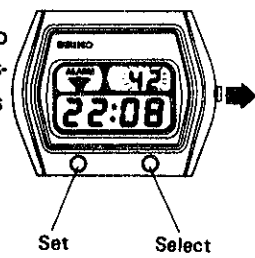
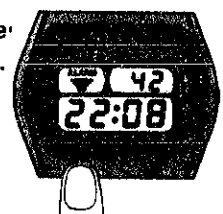
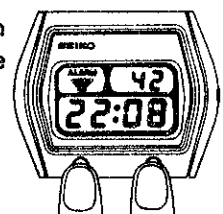
	Procedure	Result
CHECK BULB CONDITION	<p>Check to see if there is a broken filament in the bulb.</p> <ol style="list-style-type: none"> (1) Set up the volt-ohm-meter. Range to be used: OHMS R X 1 (2) Measuring Apply red and black probes of the volt-ohm-meter to the two terminals of the bulb. 	<p>Lights up → Normal Does not light up → Defective Replace the bulb with a new one.</p>
CHECK FUNCTIONING	<p>Check to see if the changeover and the adjustment of the display can be made correctly by button operation.</p> <p>First check Check to see if the changeover to and from the time display and the alarm time display by depressing crown.</p>  <p>Second check With crown in the pulled out position, check to see if each display is selected and set by depressing button "A" and "B". Be sure that there is no dead segment.</p>  <p>Third check With crown in the normal position, check to see if the light is lit by depressing button "B" in.</p>  <p>Fourth check Check to see if the alarm starts sounding when buttons "A" and "B" are depressed at the same time.</p> 	

	Procedure	Result
CHECK BATTERY LIFE INDICATOR	<p>First check</p> <p>(1) Set up the Micro Test. Set the voltage at 1.1 V.</p> <p>(2) Apply the probe of the Micro Test to the watch. Clip Red (+) . . . Crown or case back Probe Black (-) . . . Battery connection</p> <p>(3) Set the time digits before 9:04:00.</p> <p>(4) Check to see if the battery life indicator functions correctly (entire display starts flashing) when the time digits pass the 9:05:00.</p> <p>Second check</p> <p>(1) Set up the Micro Test. Set the voltage at 1.5 V.</p> <p>(2) Check by following the procedures from (2) through (4) in the First check. (See "Remarks for battery change" on page 5.)</p> <p>All procedures of Disassemblings, Reassembling, Checking and Adjustment are completed.</p>	<p>Flashes → Normal Does not flash → Defective Replace the circuit block with a new one.</p> <p>Does not flash → Normal Flashes → Defective Replace the circuit block with a new one.</p>