

SEIKO

DIGITAL QUARTZ

Cal. A259A

PARTS LIST

Cal. A259A

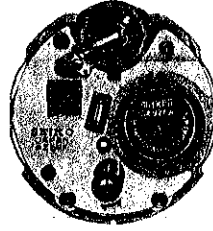

4001 230



4216 230



4216 231



4242 230



4242 231



4242 232



4245 230



4245 231



4270 230



4313 230



4313 231



4398 232

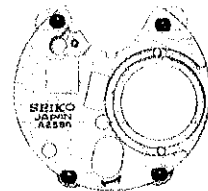

4398 234



4398 241



☆4398 248

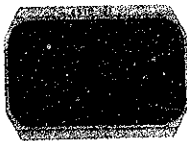

☆4510 191



4521 230

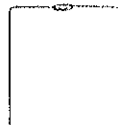

4530 230



4540 230



4540 231



4580 231



☆4580 235



4991 231



☆4991 236



☆Maxell SR926W



012 158



012 458



017 144



017 145



017 153

2/1

Cal. A259A

Characteristics

Casing diameter: ϕ 28.0 mm
 Maximum height: 4.9 mm without battery
 Frequency of quartz crystal oscillator: 32,768 Hz (Hz = Hertz Cycles per second)
 Time and calendar display: Digital Display System showing hour, minute, second, month, date and day of the week.
 Weekly alarm display: Can be set to operate at any desired minute and hour on designated day.
 Interval timer display: Can be set to operate at any desired interval (minute and hour) up to 15 hours and 59 minutes.
 Stopwatch display: Digital Display System showing 12-hour, minute and second (or minute, second and 1/100 second up to 20 minutes measurement) on both the upper row and the lower row. The lap time is displayed in the upper row and accumulated elapsed time in the lower row at the same time by simply depressing a button.
 Display medium: Nematic Liquid Crystal, FE-Mode
 Regulation system: Trimmer condenser system
 Illuminating light: Illuminates the display in the dark by depressing the light button.
 Battery life indicator: All the digits in the display begin flashing.

PART NO.	PART NAME	PART NO.	PART NAME
4001 230	Circuit block	017 153	Tube for liquid crystal panel holder screw B
4216 230	Insulator for circuit		
4216 231	Insulator for battery	☆Maxell SR926W	Silver oxide battery
4242 230	Plus terminal of battery connection	☆U.C.C. 399	
4242 231	Speaker block lead terminal A		
4242 232	Speaker block lead terminal B		
4245 230	Switch spring A		
4245 231	Switch spring B		
4270 230	Battery connection		
4313 230	Connector A		
4313 231	Connector B		
4398 232	Liquid crystal panel frame		
4398 234	Battery guard		
4398 241	Speaker block frame		
☆4398 248			
☆4510 191	Liquid crystal panel (Silver)		
☆4510 192	Liquid crystal panel (Gold)		
4521 230	Reflecting mirror		
4530 230	Bulb		
4540 230	Liquid crystal panel holder A		
4540 231	Liquid crystal panel holder B		
4580 231	Speaker block		
☆4580 235			
4991 231	Gasket for speaker block		
☆4991 236			
012 158	Screw for speaker block lead terminal B		
012 458	Liquid crystal panel holder screw		
017 144	Tube for liquid crystal panel holder screw A		
017 145	Tube for speaker block lead terminal B		

Remarks:

Liquid crystal panel

☆4510 191 } Be sure that the combination between the color of panel cover and liquid crystal
 ☆4510 192 } panel should be matched according to the "SEIKO Quartz Casing Parts List".

Speaker block frame, Spaker block, Gasket for speaker block

☆4398 248 } The parts designated with these parts numbers are manufactured specially for
 ☆4580 235 } SPORTS 100 type water resistant case. Be sure to use these parts for maintaing
 ☆4991 236 } high water-resistant quality.

Battery

The applied battery for this calibre might be added the substitutive in the future. In that case, please refer to separate "BATTERIES FOR SEIKO QUARTZ WATCHES".

☆ ⇨ Please see remarks.

Part numbers in light letters are not shown in photos.

TECHNICAL GUIDE

SEIKO DIGITAL QUARTZ

CAL. A259A

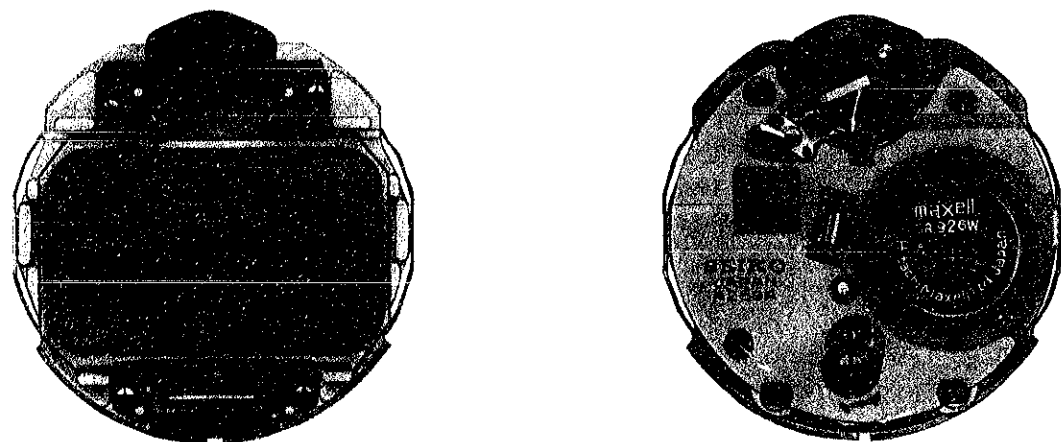

CONTENTS

I. SPECIFICATIONS	1
1. Specifications	1
2. Features	2
II. DISASSEMBLING AND REASSEMBLING OF THE CASE	3
III. DISASSEMBLING AND REASSEMBLING	5
1. Liquid crystal panel side	5
2. Switch mechanism	7
IV. CHECKING AND ADJUSTMENT	10
1. Guide table for checking and adjustment	10
2. Relationship between the segment (Liquid Crystal Panel) and the C-MOS-LSI output terminal	11
3. Procedures for checking and adjustment	12
A: Check battery voltage	12
• Check pattern segment checking system	12
B: Check conductivity of liquid crystal panel, circuit block and connector	12
C: Check circuit block and liquid crystal panel	13
D: Check current consumption	14
E: Check accuracy	14
F: Check adjustment and functioning	15
G: Check bulb condition	15
H: Check conductivity of switch components	15
I: Check speaker block	16

Calibre A259A

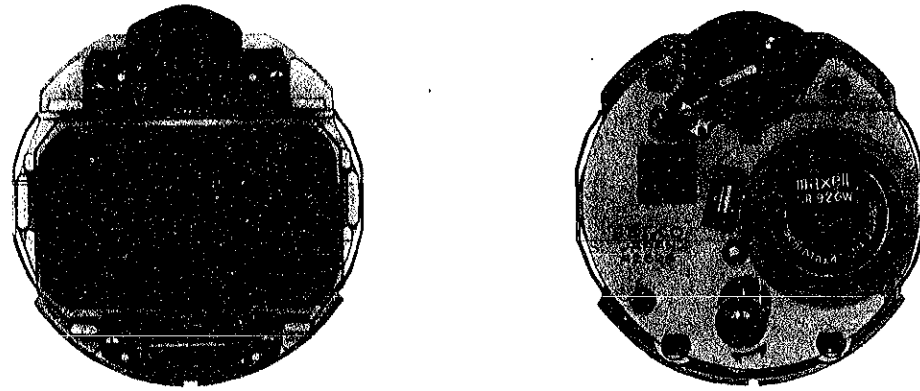

Module

I. SPECIFICATIONS

1. Specifications

Item	Cal. No. A259A
Display medium	Nematic Liquid Crystal, FEM (Field Effect Mode)
Display system	<ul style="list-style-type: none"> ● Time and calendar display Hour, minute, second, month, date and day of the week <ul style="list-style-type: none"> ○ 12-hour digital display system ○ Automatic calendar system (Automatically adjusts for even and odd months except February of leap years.) ○ "A" (for A.M.)/"P" (for P.M.) mark is displayed only when the time digits are adjusted. ● Weekly alarm display Upper row: Alarm set time <ul style="list-style-type: none"> ○ Digital display system showing hour, minute, "A" (for A.M.)/"P" (for P.M.), day of the week, function mark and alarm mark. ○ 12-hour digital display system Lower row: Present time <ul style="list-style-type: none"> ○ Digital display system showing hour, minute and second. ● Interval timer display Upper row: Alarm set time <ul style="list-style-type: none"> ○ Digital display system showing hour, minute, function mark and alarm mark. ○ 16-hour digital display system Lower row: Elapsed time <ul style="list-style-type: none"> ○ Digital display system showing hour, minute and second. ● Stopwatch display Upper row: Lap time <ul style="list-style-type: none"> ○ Digital display system showing minute, second, 1/100 second and function mark.

	Lower row: Accumulated time <ul style="list-style-type: none"> ○ Digital display system showing minute, second and 1/100 second. ○ 12-hour digital display system (When the measuring time is over 20 minutes, the display is slid automatically to "hour, minute and second" from "minute, second and 1/100 second".)
Additional mechanism	<ul style="list-style-type: none"> ● Time signal function <ul style="list-style-type: none"> ○ The alarm rings every hour on the hour. ● Weekly alarm function <ul style="list-style-type: none"> ○ The alarm rings for 20 seconds at the designated time on the set day of the week. ● Interval timer function <ul style="list-style-type: none"> ○ The alarm rings for 10 seconds. (It rings for 5 seconds when the interval is set up to 15 minutes.) ○ Forced repeater: Instant reset to the set time while the interval is measured. ○ Confirmation sound for operation ● Stopwatch function <ul style="list-style-type: none"> ○ Confirmation sound for operation ● Alarm test system <ul style="list-style-type: none"> ○ It functions only when the time and the weekly alarm are displayed. ● Battery life indicator ● Illuminating light ● Changeover confirmation sound
Crystal oscillator	32,768 Hz (Hz = Hertz . . . Cycle per second)
Loss/gain	Loss/gain at normal temperature range Monthly rate: less than 10 seconds (Annual rate: less than 2 minutes)
Casing diameter	φ 28.00 mm
Height	4.9 mm without battery
Operational temperature range	-10°C ~ +60°C (14°F ~ 140°F)
Regulation system	Trimmer condenser
Battery life	Battery life is approximately 1 year. When the bulb is used: 5 seconds or less per day When the weekly alarm is used: 20 seconds or less per day When the interval timer is used: 20 seconds or less per day
Battery power	Silver oxide battery Maxell SR926W Voltage: 1.55 V
IC (Integrated Circuit)	C-MOS-LSI 1 unit Bipolar IC 1 unit

2. Features

SEIKO Digital Quartz Alarm Chronograph A259A is a multifunctional digital watch which, in addition to the time and calendar function, is also provided with the stopwatch function capable of measuring both the lap time and the accumulated time at the same time as well as the weekly alarm function (enables the alarm to ring at the designated time and day) and the interval timer function (enables the alarm to ring repeatedly at every designated interval).

II. DISASSEMBLING AND REASSEMBLING OF THE CASE

Disassembling procedures Figs.: ① ~ ⑫

Reassembling procedures Figs.: ⑫ ~ ①

- **Lubricating** Silicone grease 500,000 c.s.
Normal quantity

● How to set the case back

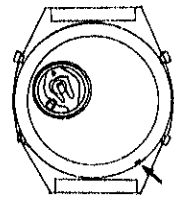

Set the case back in the case bezel so that the notch of the case back lines up to the punch mark on the case bezel. Be careful that the case back gasket does not come out.

● How to disassemble the glass and the buttons

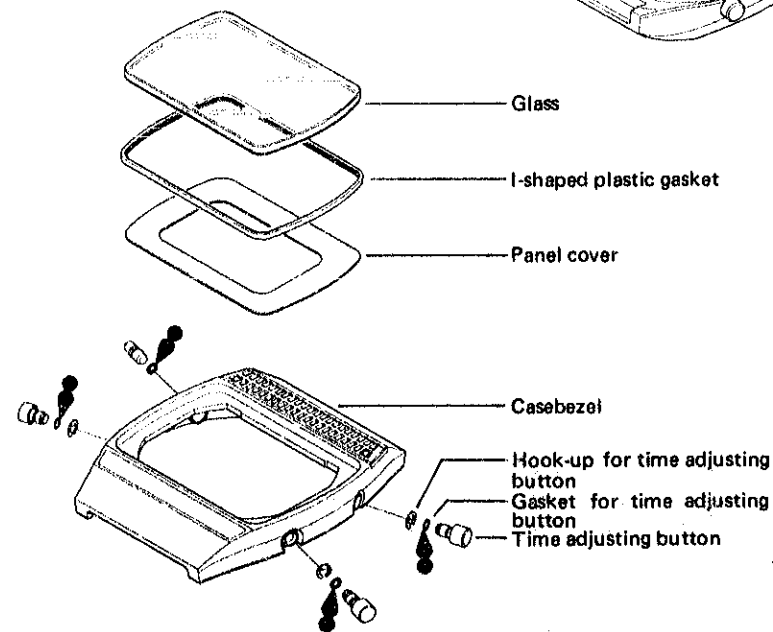

It is not necessary to disassemble them except when they are required to be replaced. Be sure to lubricate the gasket if they are disassembled and before reassembling.

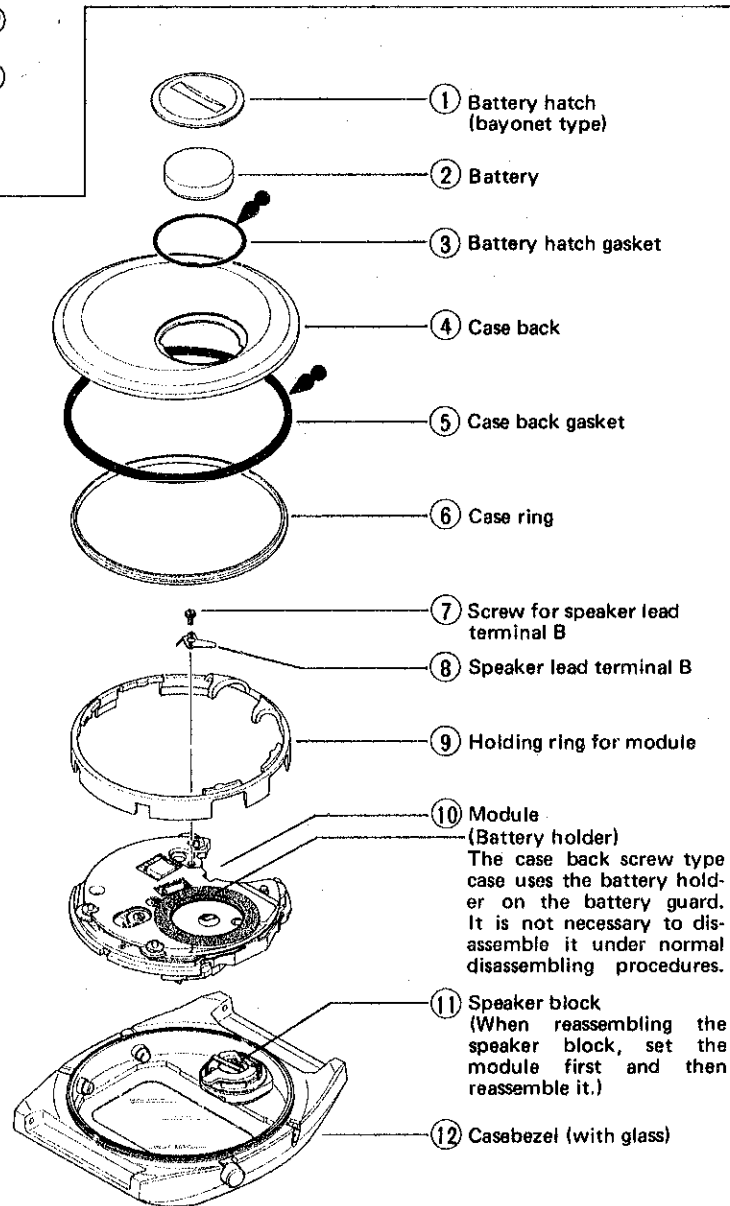

Remarks for disassembling and reassembling

⑧ How to set the speaker lead terminal B

Set the speaker lead terminal B to the battery guard as shown in the illustration on the right. Handle the speaker lead terminals A and B so as not to deform them.

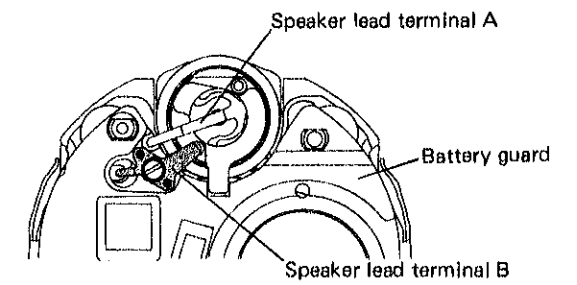

⑩ How to disassemble the module

● Disassembling

Hold the battery guard with tweezers and pull out the module toward you so as not to deform the tip (arrow-marked portion) of the speaker lead terminal A.

● Reassembling

When the protrusion of the center pole unit of the speaker is out of position, set it in position by turning it with tweezers.

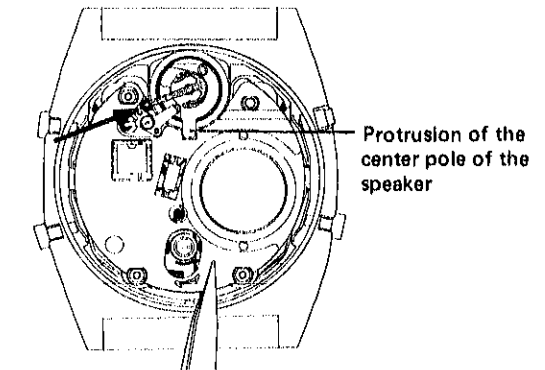

⑪ Speaker block

- As the speaker block is fixed to the case bezel, disassemble it by inserting the tips of tweezers under it and lifting it up.
- When holding and lifting up the protrusion of the center pole unit of the speaker with tweezers, it may occur that only the center pole unit of the speaker is removed. Set the speaker block so that dust may not enter inside.
- When the vibrating plate or sound diaphragm is deformed, it may cause the tone or volume of the alarm to change. Be sure to handle it carefully.

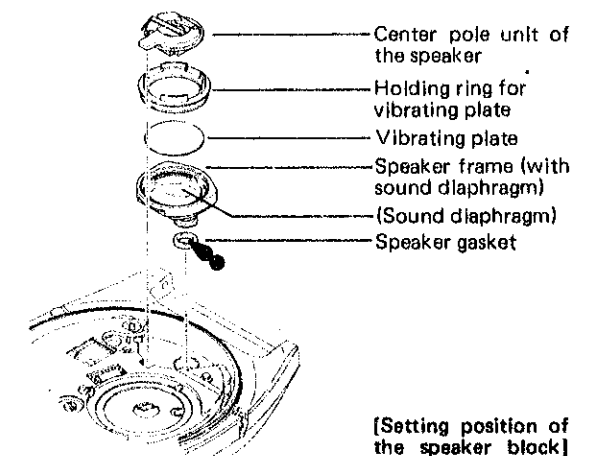
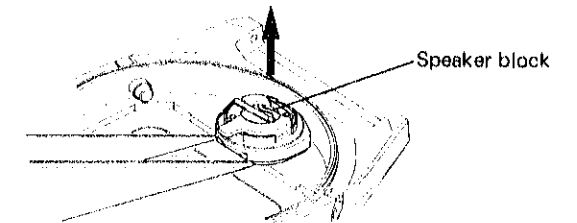

[Setting position of the speaker block]

- Refer to the Technical Guide for Cal. A229A for disassembling and reassembling of the glass.

III. DISASSEMBLING AND REASSEMBLING

Disassembling procedures Figs.: ① ~ ⑯

Reassembling procedures Figs.: ⑯ ~ ①

- Use the module holder S-645 for disassembling and reassembling.

1. Liquid crystal panel side

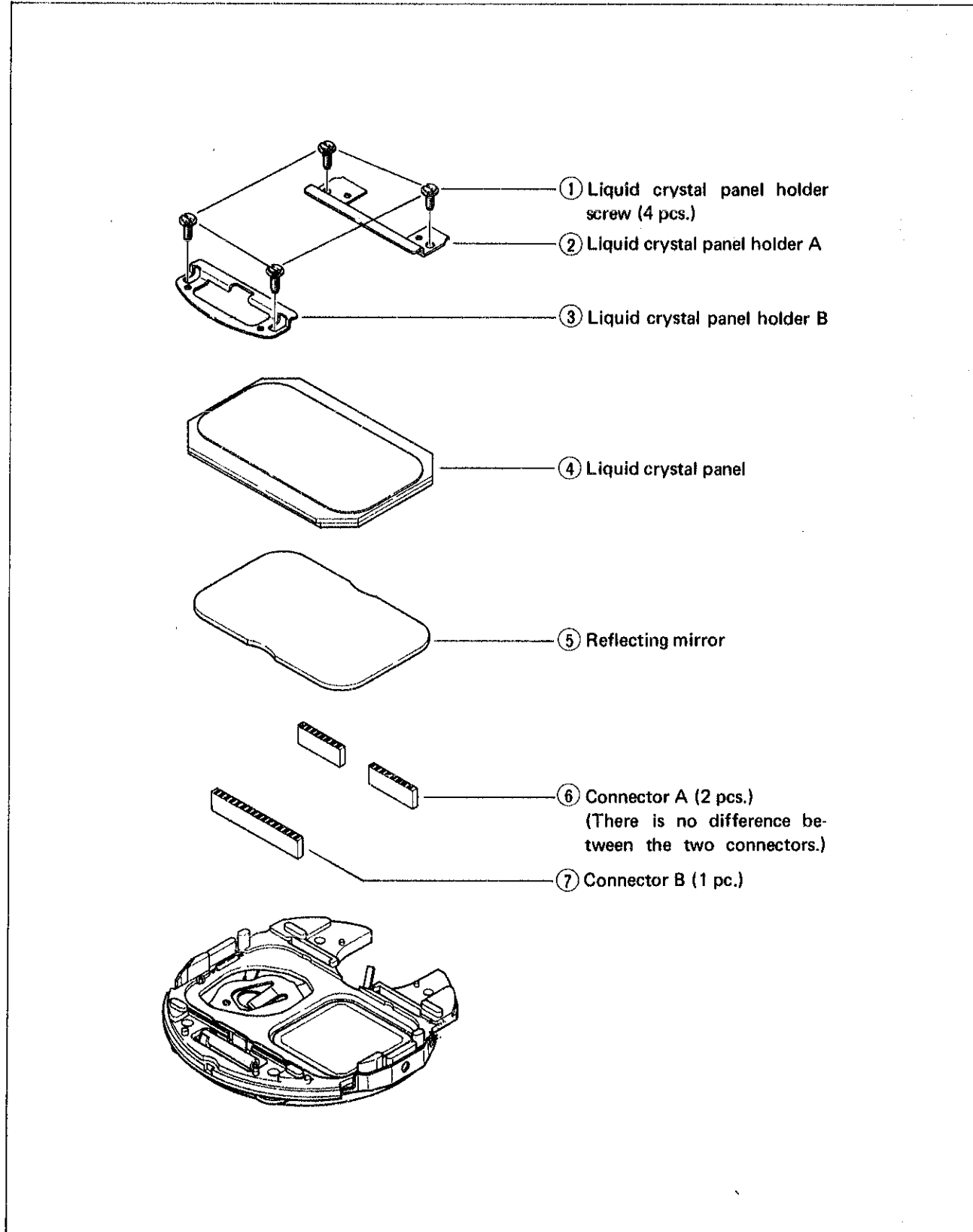

Remarks for disassembling and reassembling

④ Liquid crystal panel

Be sure to handle the liquid crystal panel with a fingercot. Be careful not to push hard the surface of the liquid crystal panel with a finger.

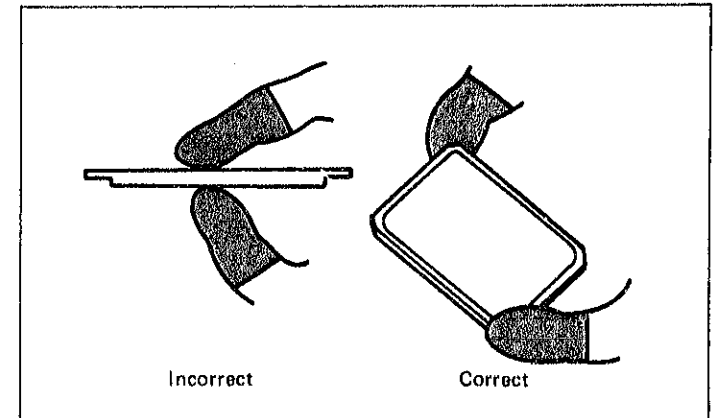

Be sure to reassemble the liquid crystal panel to the liquid crystal panel frame.

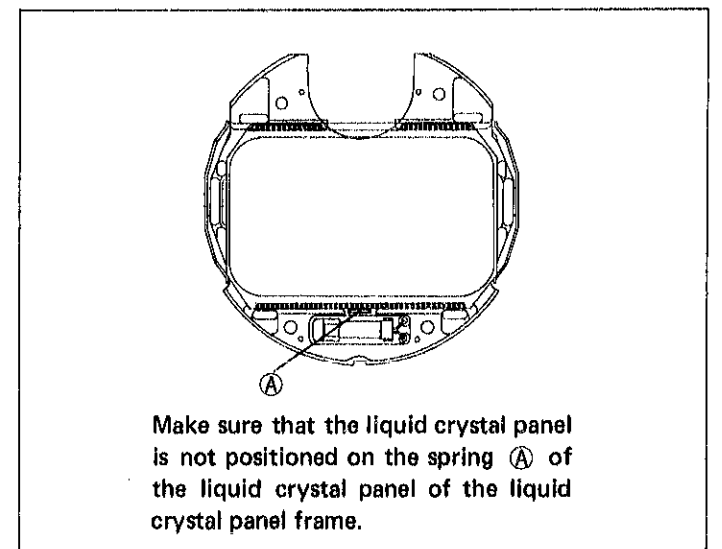

⑤ Reflecting mirror

Be sure to handle the reflecting mirror with a fingercot. When it is handled with tweezers, it may cause the surface to be scratched.

⑥⑦ Connector A, B

There are used 3 connectors. The black portions are conductive. Check to see if there is any scratch, contamination, dust or lint.

2. Switch mechanism

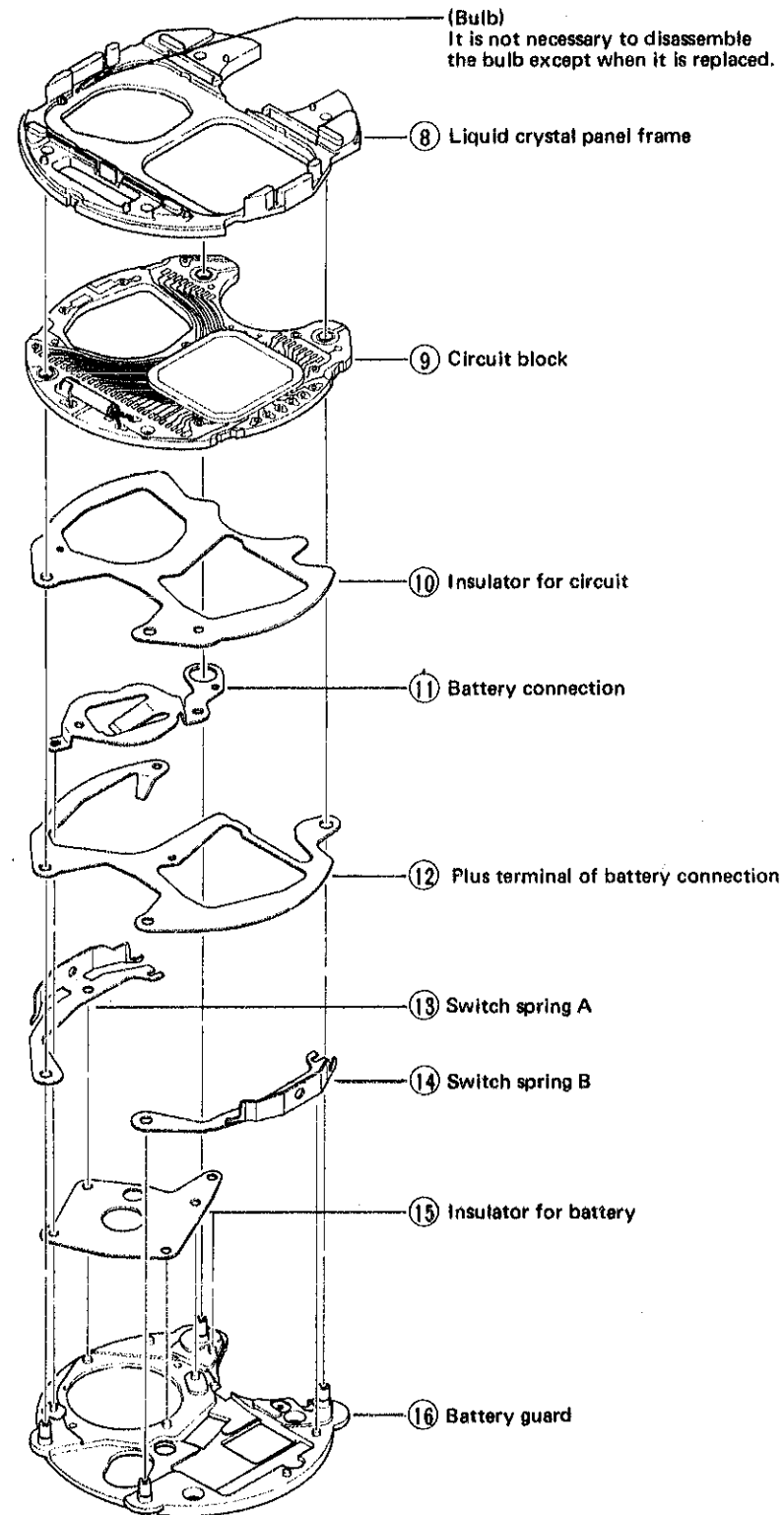

Remarks for disassembling and reassembling

⑧ Liquid crystal panel frame

When the bulb is reassembled to the liquid crystal panel frame, bend the bulb lead terminals correctly and set them in position as shown in the illustration on the right.

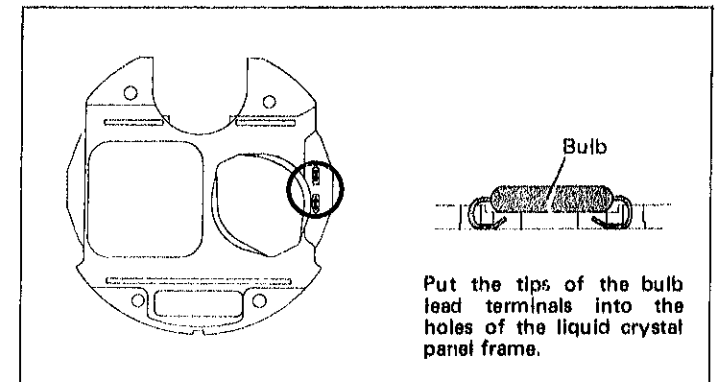

⑫ Plus terminal of battery connection

The plus terminal of the battery connection is thin. Be sure to handle it so as not to deform it.

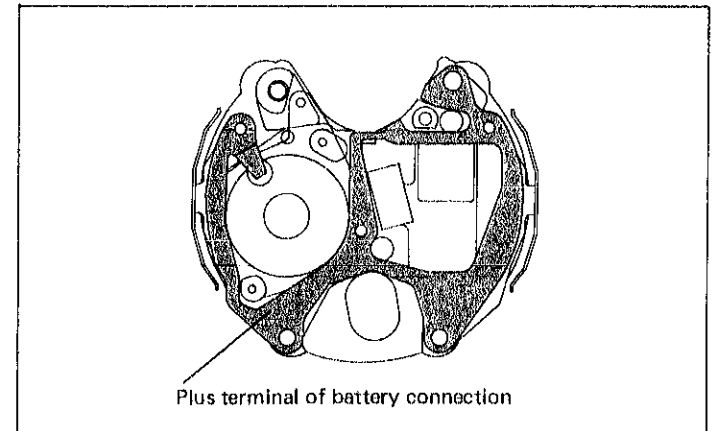

⑬ ⑭ Switch spring A, B

Reassemble the switch springs A and B to the battery guard as shown in the illustration on the right. Be careful not to mistake the front for the back. The switch components are on the front side (upper side).

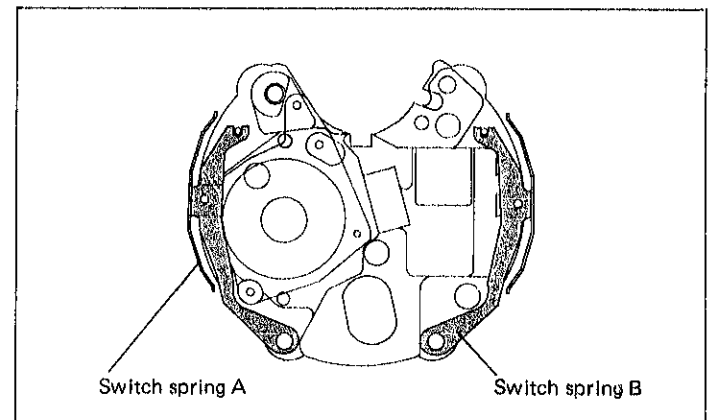

⑮ Insulator for battery

Reassemble the insulator for battery to the battery guard as shown in the illustration on the right.

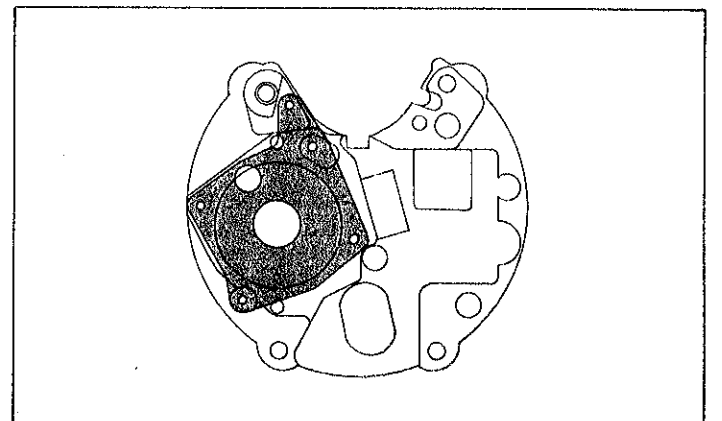

IV. CHECKING AND ADJUSTMENT

1. Guide table for checking and adjustment

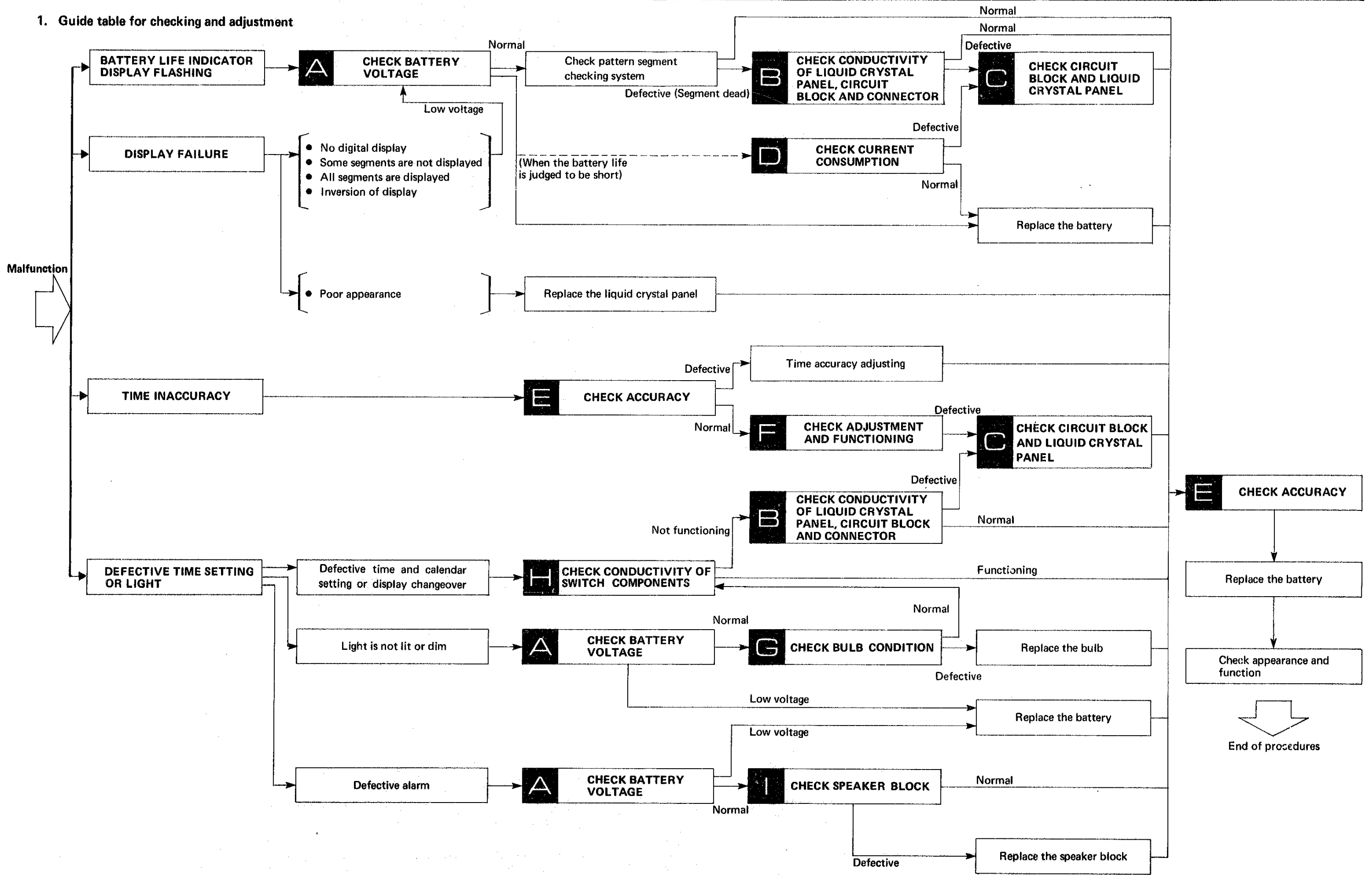

2. Relationship between the segment (Liquid Crystal Panel Electrode) and the C-MOS-LSI output terminal

- Designation of segment

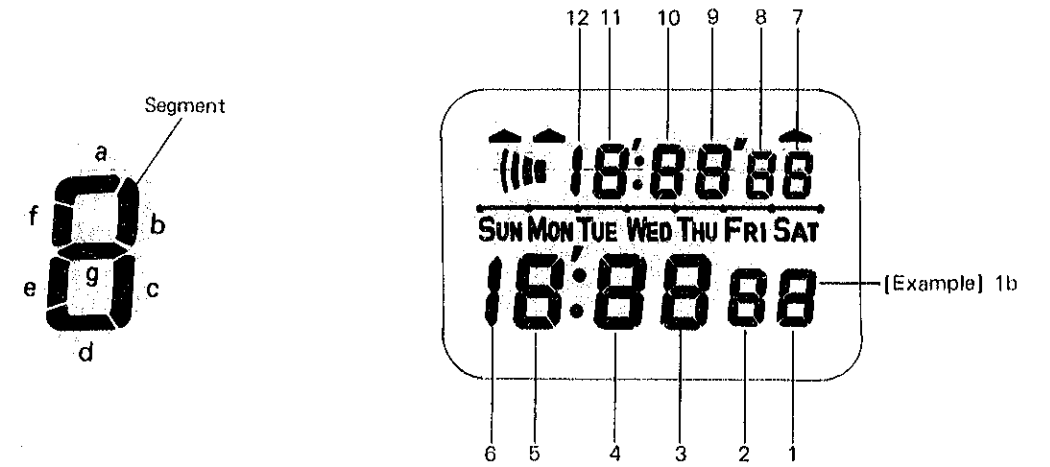

Common electrode (1) is connected electrically with segments.
 Common electrode (2) is connected electrically with segments.

IV. CHECKING AND ADJUSTMENT

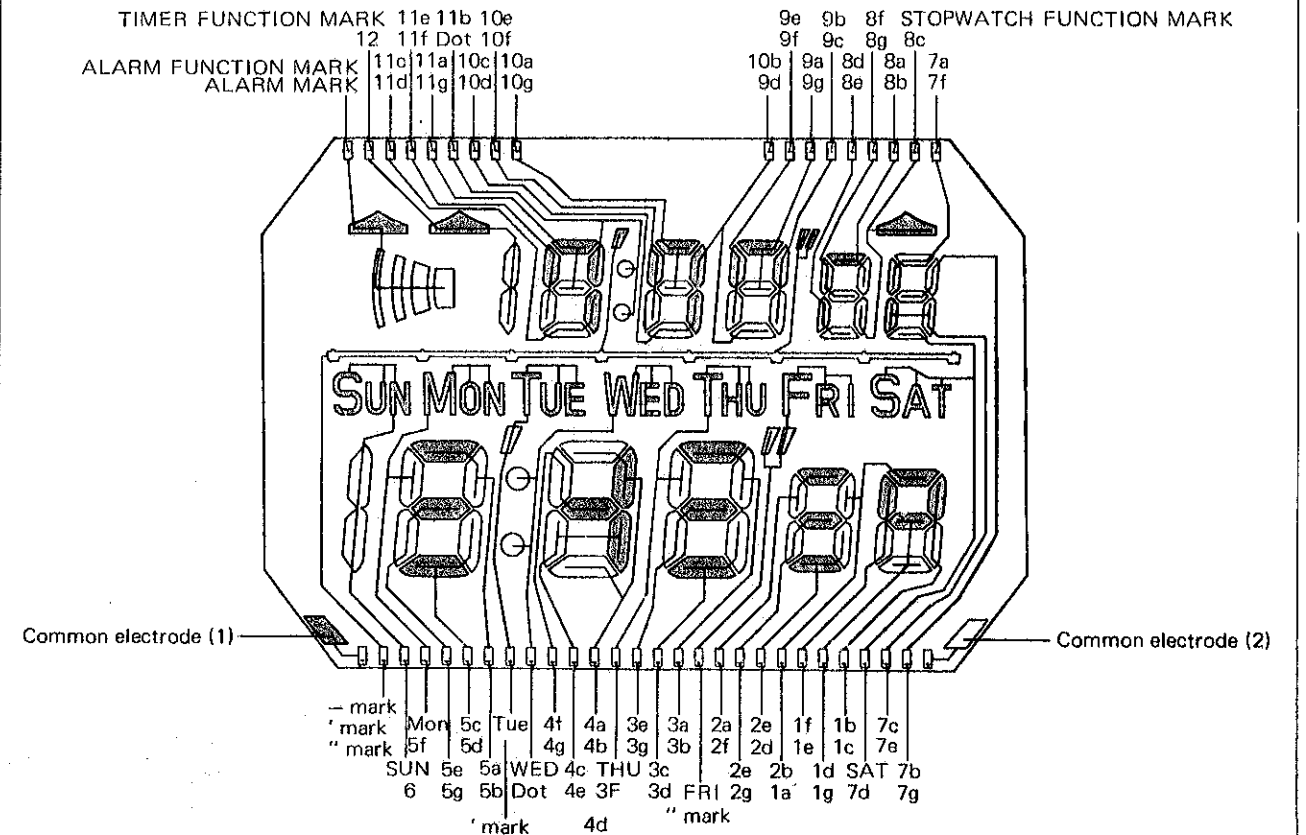
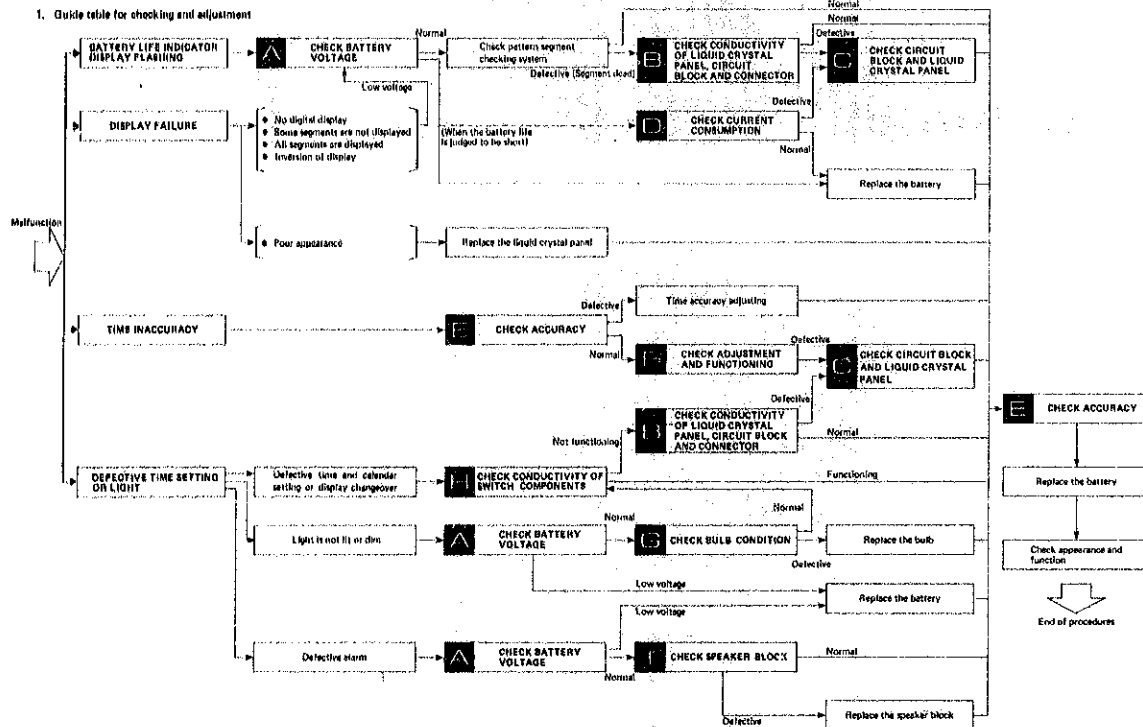

3. Procedures for checking and adjustment

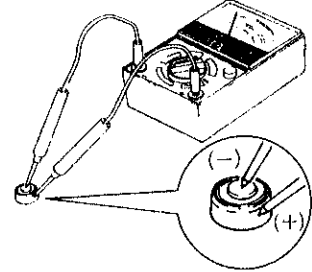
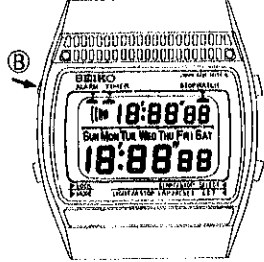
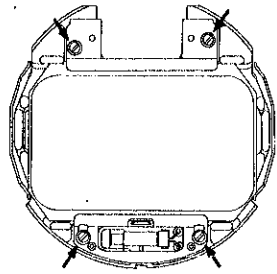
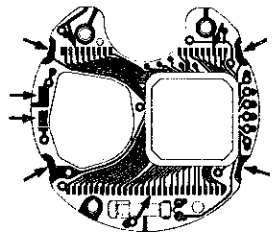
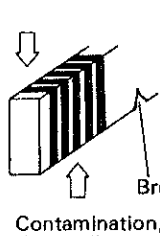
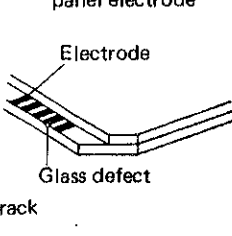
	Procedures	Result and repair
<p style="writing-mode: vertical-rl; transform: rotate(180deg);">CHECK BATTERY VOLTAGE</p>	<p>Check battery voltage.</p> <ul style="list-style-type: none"> Set up the volt-ohm-meter. Range to be used: DC 3 V Measuring Probe Red (+) Battery surface (+) Probe Black (-) Battery surface (-) 	<p>More than 1.5 V: Normal Less than 1.5V: Defective Replace the battery with a new one.</p>
<p style="writing-mode: vertical-rl; transform: rotate(180deg);">CHECK PATTERN SEGMENT CHECKING SYSTEM</p>	<p>When the button B on the upper left is depressed and held for 3 to 4 seconds, all the segments are displayed. Check to see which segment is defective. (When all the segments are lit, the daily rate can be easily measured.)</p> 	<p>Only one segment does not light up: Proceed to Replace the liquid crystal panel. Two or more segments are not displayed: Proceed to 1.4.</p>
<p style="writing-mode: vertical-rl; transform: rotate(180deg);">CHECK CONDUCTIVITY OF LIQUID CRYSTAL PANEL, CIRCUIT BLOCK AND CONNECTOR</p>	<p>(1) Check to see if the screws are tightened firmly.</p>  <p>(2) Check for dust, lint, contamination, break, scratch or crack on the conductive portions shown in the illustration below.</p> <div style="display: flex; justify-content: space-around;"> <div data-bbox="1774 1583 2030 1839"> <p>Circuit block</p>  <p>Check the sides of 4 switch components.</p> </div> <div data-bbox="2071 1583 2220 1839"> <p>Connector</p>  <p>Break or crack Contamination, dust or lint</p> </div> <div data-bbox="2258 1583 2475 1839"> <p>Liquid crystal panel electrode</p>  <p>Electrode Glass defect</p> </div> </div>	<p>No loosened screws: Normal Proceed to 1.4 (2). Loosened screws: Defective Retighten the screws.</p> <p>No dust, lint or contamination: Normal Dust, lint or contamination: Defective Wipe off any foreign matter.</p> <p>No break, crack or scratch: Normal Break, crack or scratch: Defective Replace with new ones.</p>

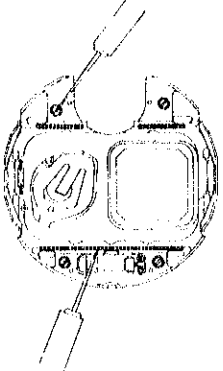
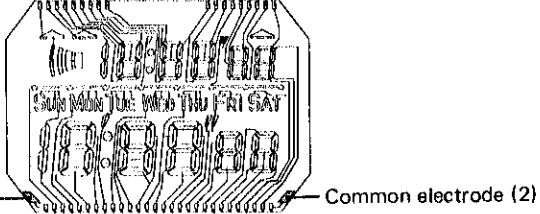
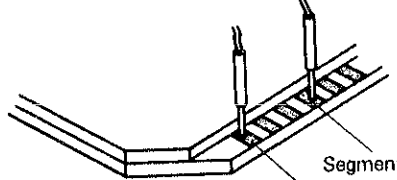
	Procedures	Result and repair
C	<p>1. Check to see if the electric signal flows into the connector from the circuit block correctly.</p> <p>(1) Remove the liquid crystal panel.</p> <p>(2) Tighten the liquid crystal panel holder screws (4 pcs.) and supply the voltage power (1.5 V). Use the battery or the Electricity Supplier (S-833) for supplying voltage power.</p> <div style="display: flex; align-items: center; margin-top: 10px;">  <div style="margin-left: 10px;"> <p>Set up the volt-ohm-meter. Range to be used: DC 3 V Probe Red (+) Screw heads Probe Black (-) Black portions of the connector (Apply the probe to several portions.)</p> </div> </div> <p>2. Check for broken coil wire, short circuit, etc. of the liquid crystal panel.</p> <p>(1) Turn the liquid crystal panel upside down.</p> <p>(2) Set up the volt-ohm-meter. Range to be used: OHMS R x 1 (Any range will do if more than 3 V is applied to the terminal of the volt-ohm-meter.)</p> <p>(3) Apply the probes to the common electrode and the segment electrode of the liquid crystal panel. (Either red or black probe will do.)</p> <div style="display: flex; align-items: center; margin-top: 10px;">  <div style="margin-left: 10px;"> <p>Common electrode (1) Common electrode (2)</p> </div> </div> <div style="display: flex; align-items: center; margin-top: 10px;">  <div style="margin-left: 10px;"> <p>Segment electrode</p> <p>Common electrode</p> </div> </div> <ul style="list-style-type: none"> ● The two common electrodes are provided on the liquid crystal panel. Each segment shows up by the potential difference between each segment and one of the two common electrodes. ● See the illustration on page 11 for the combination of each segment and the common electrodes (1) and (2). 	<p>More than 0.8 V: Normal Less than 0.8 V: Defective Replace the circuit block with a new one.</p> <p>Lights up: Normal Does not light up: Defective Replace the liquid crystal panel.</p>

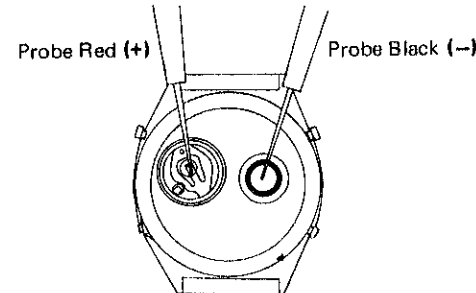
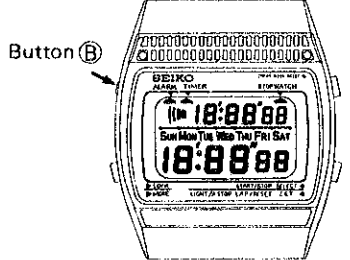
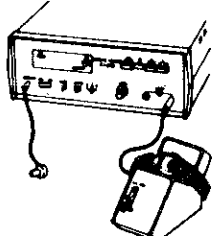
	Procedures	Result and repair
D	<p>Check to see if the current consumption is normal.</p> <p>(1) Set up the volt-ohm-meter. Range to be used: DC 12 μA</p> <p>(2) Measuring Probe Red (+) Battery connection Probe Black (-) Battery surface (-)</p> <p>Measure the current consumption in such a manner as shown in the illustration below.</p> <div style="display: flex; align-items: center; margin-top: 10px;">  <div style="margin-left: 10px;"> <p>Probe Red (+) Probe Black (-)</p> </div> </div> <p>Note: If the pointer of the volt-ohm-meter scales out the maximum value and the current consumption cannot be measured, reset its range, e.g. at DC 30 mA. Next, when the pointer is stabilized, return the range to DC 12 μA (or 0.03 mA) with the probes applied and read the value indicated.</p>	<p>Less than 2.5 μA: Normal Replace the battery with a new one. More than 2.5 μA: Defective Proceed to 13.</p>
E	<p>Check loss and gain of time.</p> <p>(1) In the time display, depress and hold button (B) for 3 to 4 seconds and light up all the segments. When all the segments are lit, the daily rate can be easily measured.</p> <div style="display: flex; align-items: center; margin-top: 10px;">  <div style="margin-left: 10px;"> <p>Button (B)</p> <p>Depress any one of the buttons to return the display to the time display.</p> </div> </div> <p>(2) Set up the Quartz Tester. Use the Electric-field detection microphone for the liquid crystal watch.</p> <div style="display: flex; align-items: center; margin-top: 10px;">  </div>	<p>Does not lose or gain: Normal</p> <p>Loses or gains: Defective Proceed to Time accuracy adjusting. Time accuracy is adjusted by turning the trimmer condenser.</p>

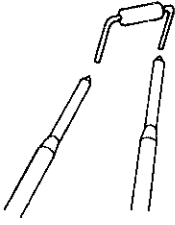
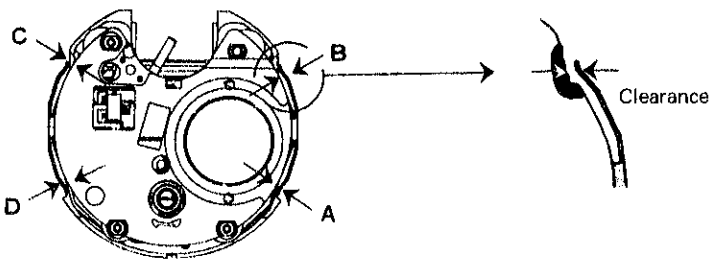
	Procedures	Result and repair
CHECK ADJUSTMENT AND FUNCTIONING	<p>Check to see if the display can be changed and adjusted correctly by button operation.</p> <p>(1) Check the adjustment. Check to see if the button operation and the adjustment correspond correctly in all time adjusting functions.</p> <ul style="list-style-type: none"> Check the watch in all adjusting functions through more than one round of functioning. <p>(2) Check the functioning.</p> <ul style="list-style-type: none"> Check to see if the time display, weekly alarm display, interval timer display and stopwatch display change and function correctly. 	<p>Function correctly and can be adjusted:</p> <p>Normal: Proceed to 3.</p> <p>Does not function correctly or cannot be adjusted:</p> <p>Defective: Replace the circuit block with a new one.</p>
CHECK BULB CONDITION	<p>Check to see if the bulb functions correctly.</p> <p>(1) Set up the volt-ohm-meter. Range to be used: OHMS R x 1</p> <p>(2) Measuring Apply the probes to both sides of the bulb. (Either red or black probe will do.)</p> 	<p>Lights up: Normal Does not light up: Defective</p> <p>Replace the bulb with a new one.</p>
CHECK CONDUCTIVITY OF SWITCH COMPONENTS	<p>Check to see if the switch components function correctly (with the module reassembled).</p>  <p>(1) Check to see if when the switch spring portions A, B, C and D are pushed with tweezers, they contact the circuit block electrode and to see if when the tweezers are released, there is a clearance about twice the width of the switch spring.</p> <p>(2) Check for any dust, lint or contamination on the conductive portions.</p>	<p>Functions correctly: Normal</p> <p>Proceed to 4 (2).</p> <p>Does not function correctly: Defective (If adjustment is impossible, replace the switch spring with a new one.)</p> <p>No dust, lint or contamination: Normal Dust, lint or contamination: Defective Wipe off any foreign matter.</p>

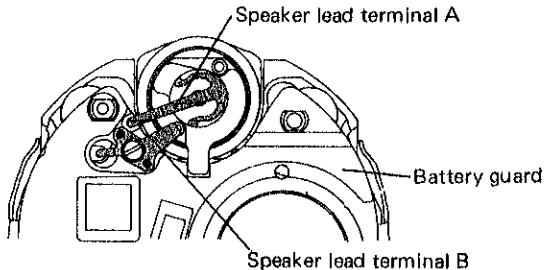
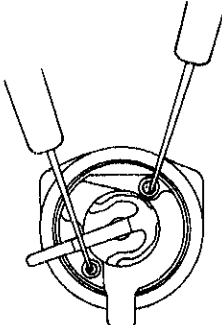
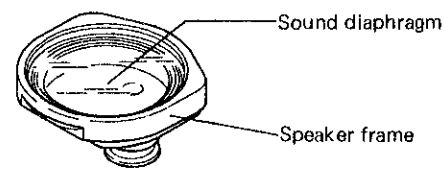
	Procedures	Result and repair
CHECK SPEAKER BLOCK	<p>Check to see if the alarm rings correctly.</p> <p>(1) In case the alarm does not ring:</p> <p>(1) Check for contamination of the speaker lead terminals A and B and the circuit block electrode and for deformation of the lead terminals.</p>  <p>(2) Measure the coil resistance inside the speaker block and check for broken coil wire or short circuit.</p> <p>1. Set up the volt-ohm-meter. Range to be used: OHMS R x 1</p> <p>2. Measuring Apply the probes to the two speaker lead pin heads of the insulator for speaker.</p>  <p>(2) In case the alarm does not sound correctly: Check for any dust or contamination inside the speaker block or for deformation of the vibrating plate and the sound diaphragm. (The sound diaphragm is fixed to the speaker frame and cannot be disassembled in a single unit.)</p>  <ul style="list-style-type: none"> Refer to the "Setting position of the speaker block" on page 4 for disassembling and reassembling of the speaker block. 	<p>Uncontaminated or undeformed: Normal Contaminated: Defective Wipe off any contamination. Deformed: Defective Correct it with tweezers.</p> <p>120 Ω ~ 140 Ω → Normal Less than 120 Ω (Short circuit) → Defective More than 140 Ω (Broken coil wire) → Defective</p> <p>Replace the speaker block with a new one.</p> <p>Uncontaminated, undeformed or no dust: Normal Contaminated or dust: Defective Wipe off any foreign matter. Deformed: Defective If correction is impossible though the speaker frame has been replaced, replace the speaker block with a new one.</p>