

SEIKO

DIGITAL QUARTZ

Cal. A829A

**PARTS
CATALOGUE**

Cal. A829A

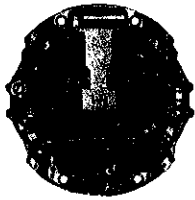
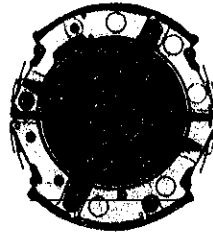
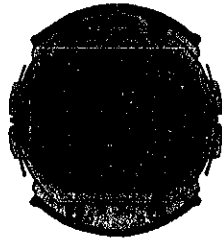

4001 243

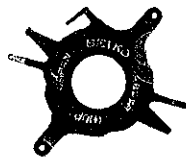

4225 245



4245 245



4245 246



4246 022



4270 245



4313 245

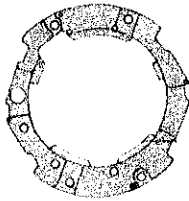

4398 266

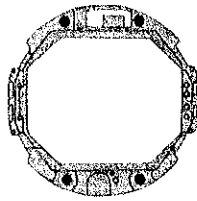

4398 267

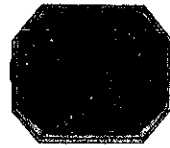

4510 165

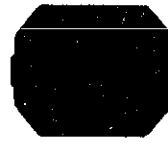

4521 165



4530 200



☆ Sanyo CR2016



012 178



017 648

TECHNICAL GUIDE

SEIKO DIGITAL QUARTZ

CAL. A829A

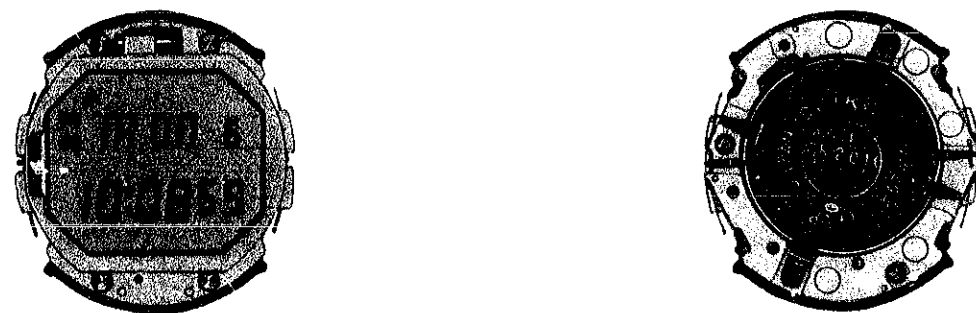

CONTENTS

I. SPECIFICATIONS	1
II. STRUCTURE OF CIRCUIT BLOCK	1
III. DISPLAY FUNCTION	2
IV. DISASSEMBLING, REASSEMBLING AND LUBRICATING OF THE CASE	3
V. DISASSEMBLING AND REASSEMBLING OF THE MODULE	5
VI. CHECKING AND ADJUSTMENT	7
• Check battery voltage	7
• Check battery conductivity	7
• Check all the segments lit up	7
• Check current consumption	7
• Check water resistance	8
• Check contact of C-MOS-LSI ~ liquid crystal panel	8
• Check liquid crystal panel and circuit block	8
• Check accuracy	9
• Check functioning and adjusting	9
• Check alarm test system	9
• Check conductivity of switch components	9
• Check alarm condition	10
• Check bulb condition	10

I. SPECIFICATIONS

Cal. No.		A829A
Item		
Display medium		Nematic liquid crystal, FEM (Field Effect Mode)
Liquid crystal driving system		Multiplex driving system
Display system		<ul style="list-style-type: none"> • Time and calendar display (12 or 24-hour indication) • Single alarm display • Daily alarm display • Dual time display • Stopwatch display • Counter function • Timer display
Additional mechanism		<ul style="list-style-type: none"> • Time signal • Alarm test system • Automatic calendar system • Illuminating light
Loss/gain		Loss/gain at normal temperature range Monthly rate: less than 15 seconds
Module size	Outside diameter	φ31.4 mm (29.6 mm between 6 o'clock and 12 o'clock sides) (27.6 mm between 3 o'clock and 9 o'clock sides)
	Casing diameter	φ28.0 mm
	Height	4.9 mm
Regulation system		Trimmer condenser
Measuring gate by quartz tester		Any gate is available.
Battery		Lithium battery Sanyo CR2016, Maxell CR2016, Matsushita BR2016 Battery life is approximately 3 years. Voltage: 3.0 V

II. STRUCTURE OF CIRCUIT BLOCK

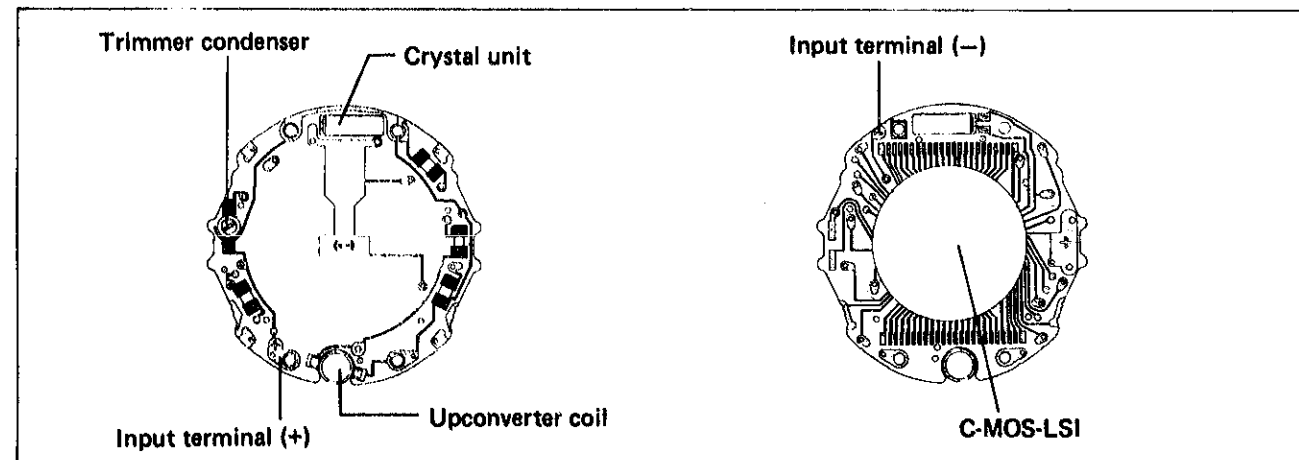

III. DISPLAY FUNCTION

Check to see if the upper display changes as shown below by turning the rotating ring clockwise to match up each mode selection word or phrase to the mode mark "▲".

Time and calendar display

- Engagement and disengagement of the hourly time signal / Activating the alarm test system.
Depress buttons "A" and "B" at the same time.

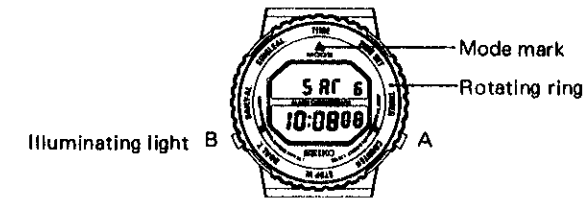

Single alarm display

Daily alarm display

- Engagement and disengagement of the alarm.
Depress button "B" in the alarm display.



Dual time display



Stopwatch display

- Reset of the stopwatch.
Depress button "B" after "STOP" appears on the panel.

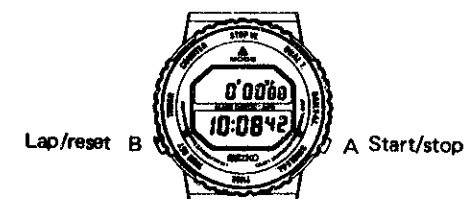

Counter display

- (1) Depress only button "A" to count when it is used as the single counter.



- (2) Depress buttons "A" and "B" respectively to count when it is used as the twin counter.

- Reset of the counter.
Depress buttons "A" and "B" at the same time.

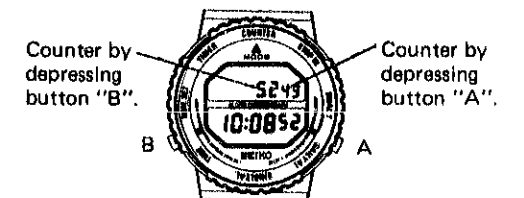

Timer display

- Disengagement of the timer.
Depress button "B" after "STOP" appears on the panel.



Time set display

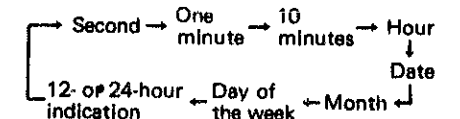
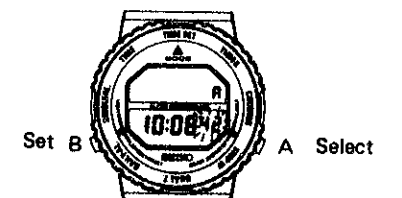

IV. DISASSEMBLING, REASSEMBLING AND LUBRICATING OF THE CASE

Disassembling procedures: ① → ⑪ Lubricating Type of oil Oil quantity

Reassembling procedures: ⑪ → ①

● Moebius A ● Normal
○ Silicone grease 500,000 c.s.

① Case back ~ ⑥ Button

① Case back

When setting the case back to the middle, use the inserting and supporting disk.

How to reassemble the module to the middle

① Turn the rotating ring and set the mode selection word "COUNTER" to mode mark "▲".

② Set the transmission pins to the inside of the middle and push them by tweezers.

* Out of four transmission pins, the two positioned side by side are projecting.

③ Set the module to the middle.

Note:

If the rotating ring is not set in the above designated manner, 3 transmission pins protrude and make it difficult to set the module.

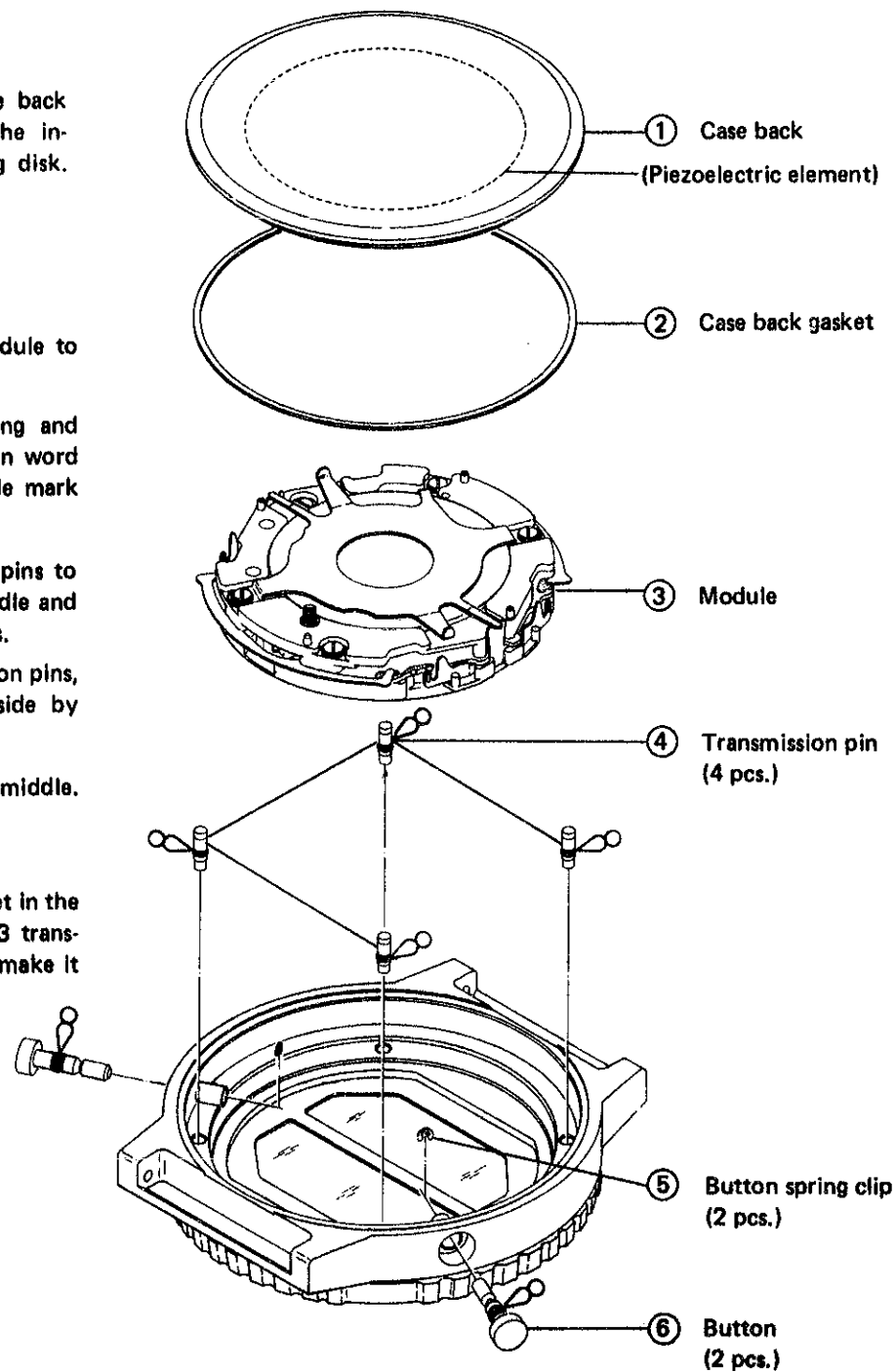

⑦ Rotating ring ~ ⑪ Middle

⑦ Rotating ring

In case the rotating ring does not rotate smoothly, lubricate the clearance between the rotating ring and the middle with Moebius A at three places or so very well.

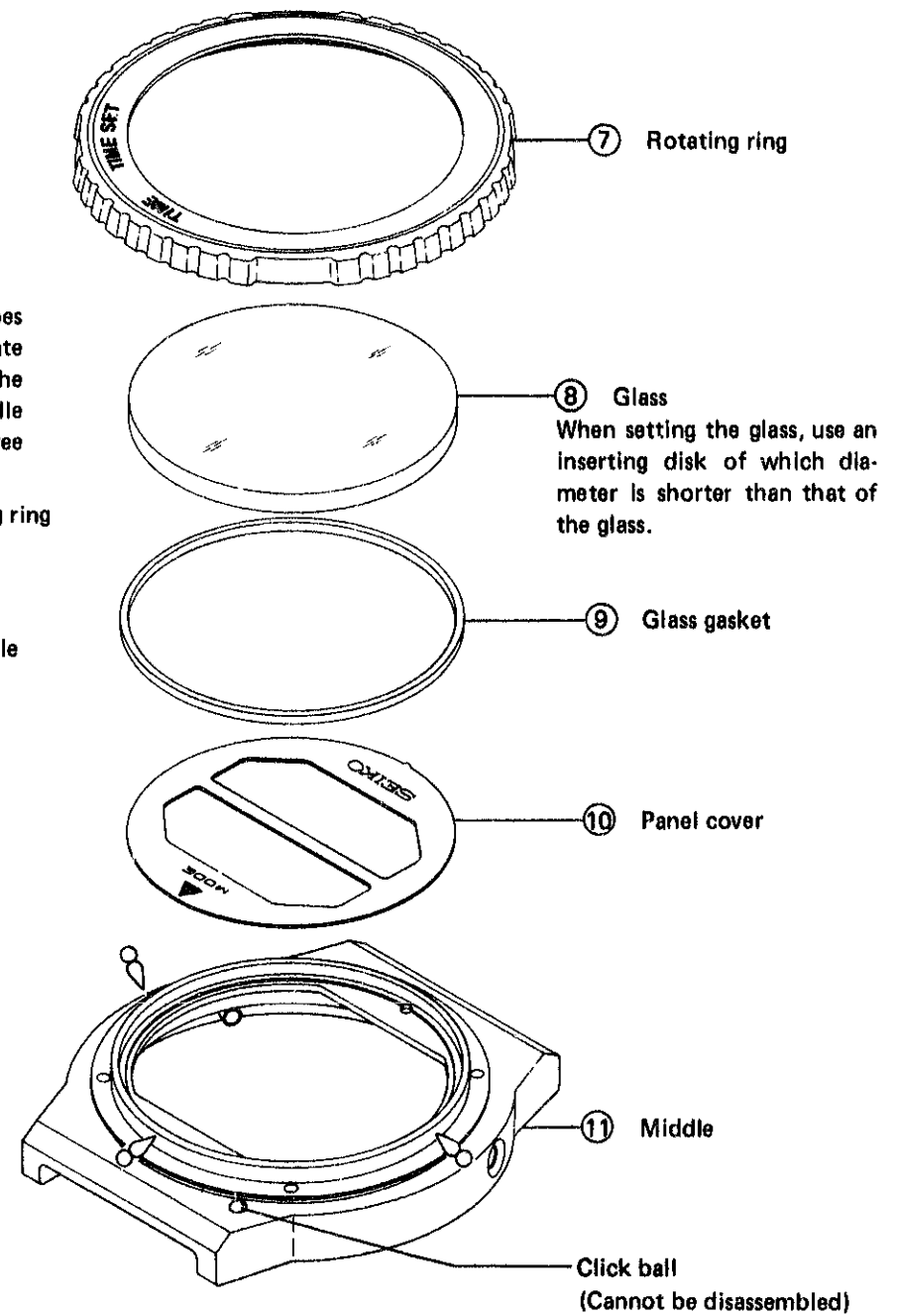
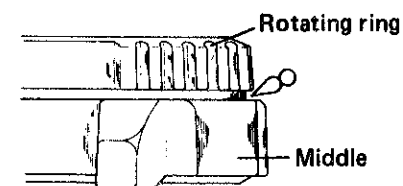

V. DISASSEMBLING AND REASSEMBLING OF THE MODULE

Disassembling procedures: ① → ⑭

Reassembling procedures: ⑭ → ①

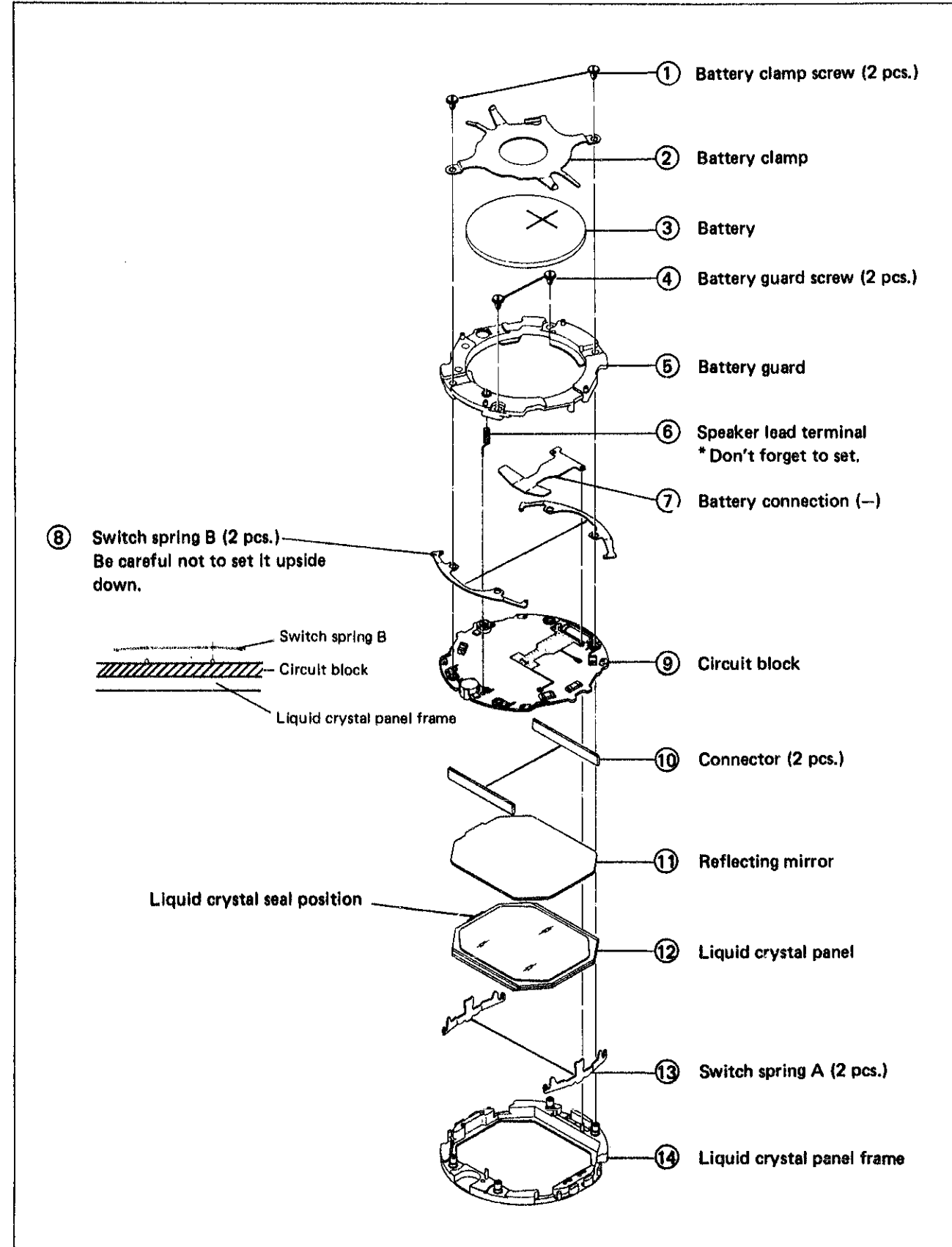

The relation between the segment (liquid crystal panel electrode) and C-MOS-LSI output terminal.

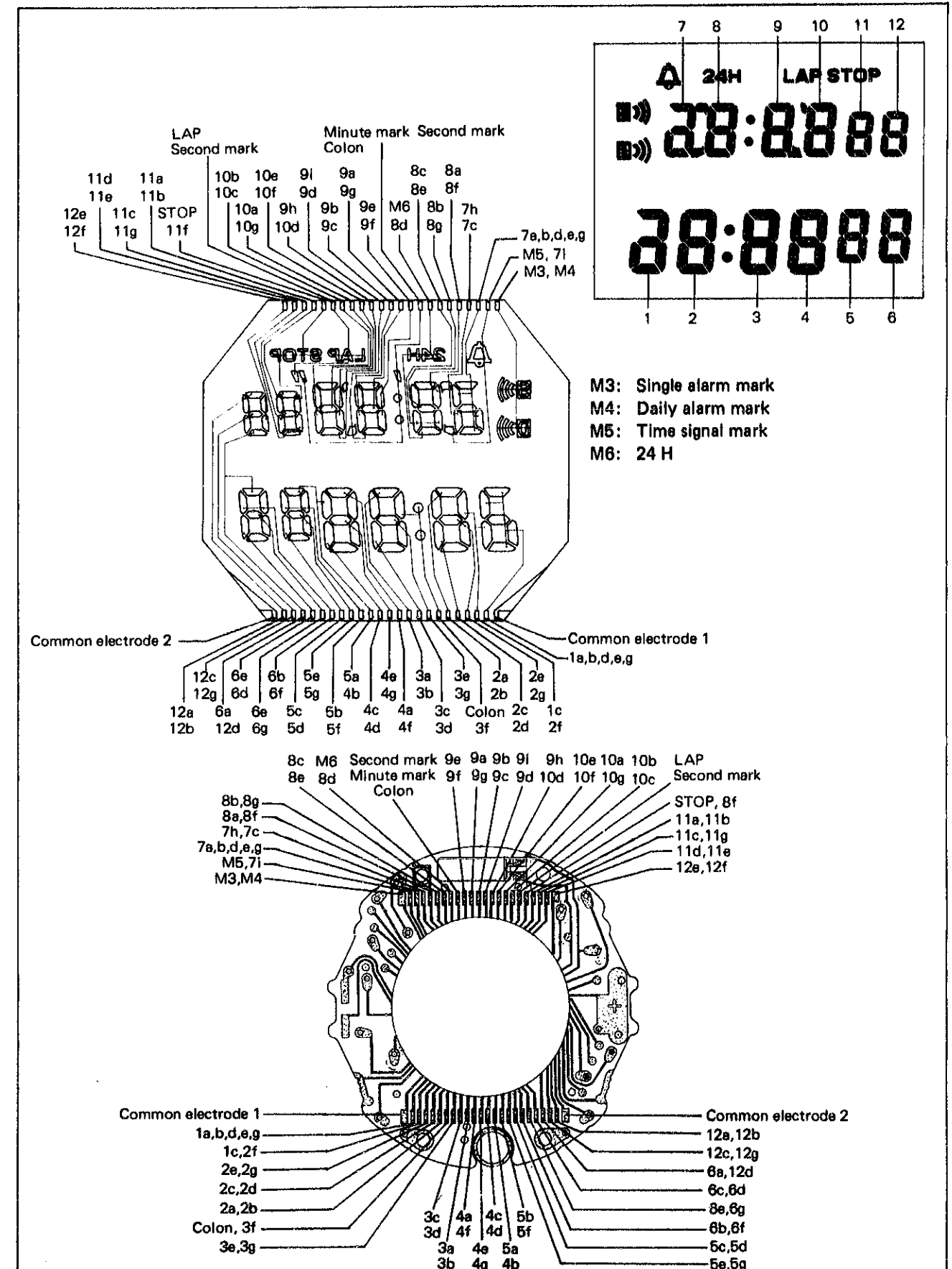

VI. CHECKING AND ADJUSTMENT

The explanation here is only for the particular points of Cal. A829A.
Refer to the "TECHNICAL GUIDE, GENERAL INSTRUCTION" for SEIKO Digital Quartz for ordinary checking and adjustment.

Procedure

● Remarks for replacing the battery

In this calibre after replacing battery, turn the rotating ring two clicks (90° degrees) with buttons "A" and "B" depressed to reset the circuit. (Turning direction is not specified.)
And follow the same procedures after checking battery voltage.

CHECK BATTERY VOLTAGE

Set up the volt-ohm-meter
Range to be used: DC 6V

Result:
Normal : More than 3.0V
Defective: Less than 3.0V

Note:

After checking battery voltage, turn the rotating ring two clicks (90° degrees) with buttons "A" and "B" depressed. (Turning direction is not specified.)

CHECK BATTERY CONDUCTIVITY

CHECK ALL THE SEGMENTS LIT UP

In the time and calendar display depress button "A" continuously for 4 to 5 seconds, and all the segments light up.
Depress button either A or B to return to the time and calendar display.

CHECK CURRENT CONSUMPTION

Set up the volt-ohm-meter
Range to be used: DC 12 μ A

Result:
Normal : Less than 1.5 μ A
Defective: More than 1.5 μ A
* Replace the circuit block or the liquid crystal panel.

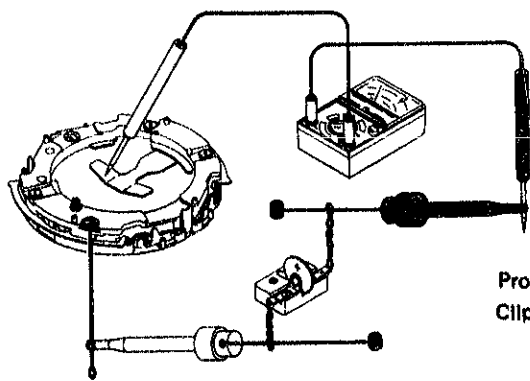

Probe red: Battery connection (-)
Clip (+) (metal bar): Battery guard screw (Near speaker lead terminal)

Procedure

* How to find defects when the current consumption is more than 1.5 μ A.
Measure the current consumption of the circuit block alone.

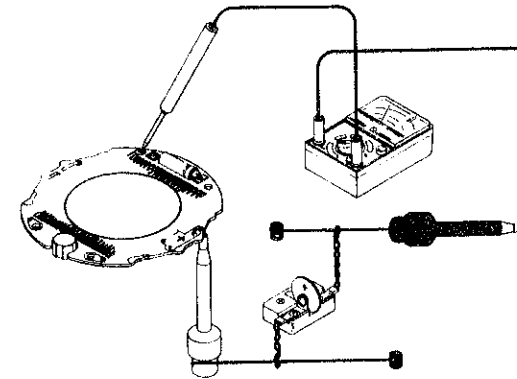

Result:

Normal : Less than 1.0 μ A
Replace the liquid crystal panel with a new one.
Defective: More than 1.0 μ A
Replace the circuit block with a new one.

CHECK WATER RESISTANCE

CHECK CONTACT OF C-MOS-LSI ~ LIQUID CRYSTAL PANEL

Refer to "Relation between the segment and C-MOS-LSI output terminal" and check for poor conductivity of the liquid crystal panel, connector and C-MOS-LSI output terminal.

CHECK LIQUID CRYSTAL PANEL AND CIRCUIT BLOCK

(1) Check to see if there are any broken wire, short circuit, etc. in the liquid crystal panel.

Set up the volt-ohm-meter
Range to be used: OHMS x 1 ~ x 1K

Result:

Normal : Lights up.
Defective: Does not light up.
Replace the liquid crystal panel with a new one.

(2) Check to see if the electric signal is transmitted correctly from the circuit block.

Set up the volt-ohm-meter
Range to be used: DC 3V

Result:

Normal : More than 0.8 V
Defective: Less than 0.8 V
Replace the circuit block with a new one.

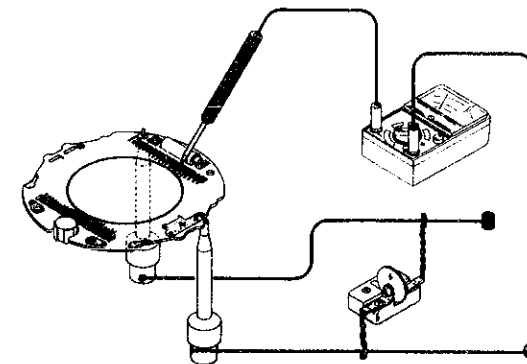

Procedure

CHECK ACCURACY

The daily rate can be easily measured if all the segments are lit.

* In the time and calendar display depress button "A" continuously for 4 to 5 seconds, and all segments light up. Depress button "A" or "B" to return to the normal display.

Result:

Normal : Neither gain nor loss.
 Defective: Either gain or loss.
 Proceed to Time accuracy adjusting.
 *Turn the trimmer condenser.

CHECK FUNCTIONING AND ADJUSTING

Check to see if the time and calendar setting and other functions are normal by referring to "DISPLAY FUNCTION" on page 2.

Result:

Normal : Operate correctly.
 Defective: Do not operate correctly.

CHECK ALARM TEST SYSTEM

In the time and calendar display depress buttons "A" and "B" at the same time.

Result:

Normal : The alarm rings.
 Defective—
 The display disappears.
 Replace the battery with a new one.
 The alarm does not ring.
 Check the alarm condition.

CHECK CONDUCTIVITY OF SWITCH COMPONENTS

Check to see if the switch components (←) operate correctly.

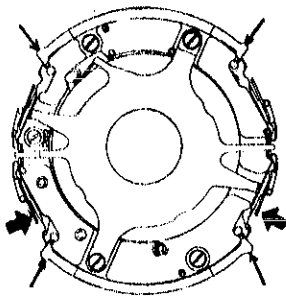

* Also check to see if the contact points of switch spring B (←) touch the circuit block in fully assembled module.

Result:

Normal : Operate correctly.
 Defective: Do not operate correctly.

Procedure

CHECK ALARM CONDITION

Check it when the alarm does not ring.

(1) Check for output voltage.

After applying the probes as shown in the illustration below, depress buttons "A" and "B" at the same time in the time and calendar display.

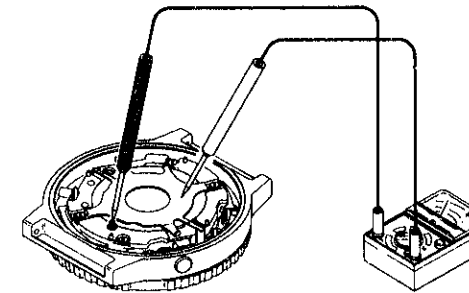

Set up the volt-ohm-meter
 Range to be used: DC 12V/A
 Probe red: Battery clamp
 Probe black: Speaker lead terminal

Result:

Normal : The pointer swings.
 Defective: The pointer does not swing.
 Check the upconverter coil.

[Remarks for measurement]

Be careful not to get the module come up.
 When the module comes up, it cannot be checked correctly.

(2) Check for upconverter coil.

Volt-ohm-meter
 Range to be used: OHMS x 1

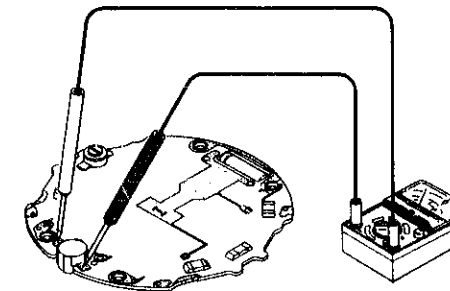

Result:

Normal : 70Ω - 90Ω
 Defective—
 Less than 70Ω (Short circuit)
 More than 90Ω (Broken wire)
 Replace the circuit block.

* When there is no defect to be found through the checking procedures above, check the piezoelectric element for break, crack, etc.

CHECK BULB CONDITION