

SEIKO

DIGITAL QUARTZ

Cal. C515A

**PARTS
CATALOGUE**

Cal. C515A

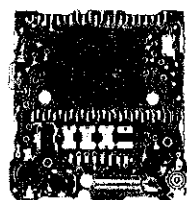
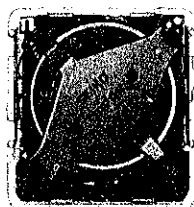
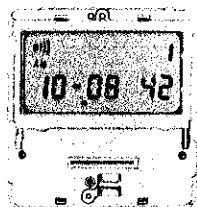

4001 830

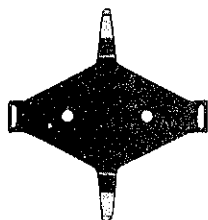

4225 830



4246 858



4246 859



4270 795

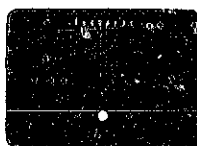

4293 830



4313 830



4313 831

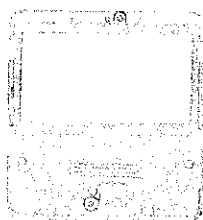

4398 830

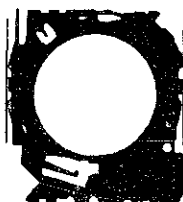

4410 830

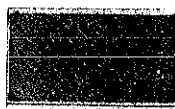

4510 825



4521 890



4530 230

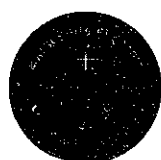

☆ Matsushita BR2016

Cal. C515A

Characteristics

Casing diameter : 26.5 × 25.0 mm
 Maximum height : 5.1 mm without battery
 Frequency of quartz crystal oscillator : 32,768 Hz (Hz=Hertz Cycles per second)
 Time and calendar display : Hour, minute, second and day of the week can be displayed in 12-hour or 24-hour indication.
 At the push of a button year, month, date, day and "A"(A.M.)/"P"(P.M.) by key operation.
 Calculator display : Can make arithmetic operations and calculation up to 8 digits by pushing the number keys with top of finger. Almost every calculation needed in daily living is possible.
 Numerical display : 2-channel numerical memory up to 8 digits.
 Alarm display : Can be set to operate at any desired hour, minute and "A"(A.P.)/"P"(P.M.).
 Stopwatch display : Digital display system showing hour, minute, second and 1/100 second up to 10 hours (9 hours, 59 minutes, 59 seconds and 99).
 Time signal : Can be set to ring every hour on the hour.
 Display medium : Nematic liquid crystal, FE-Mode.
 Regulation system : Trimmer condenser.
 Illuminating light : Illuminates all the digital displays in the dark by pushing the light button except for calculator.

PART NO.	PART NAME	PART NO.	PART NAME
4001 830	Circuit block		
4225 830	Battery clamp		
4246 858	Plus lead terminal		
4246 859	Buzzer lead terminal		
4270 795	Battery connection (—)		
4293 830	Key board switch plate		
4313 830	Connector (A)		
4313 831	Connector (B)		
4398 830	Liquid crystal panel frame		
4410 830	Circuit cover		
4510 825	Liquid crystal panel		
4521 890	Reflecting mirror		
4530 230	Bulb		
☆Matsushita BR2016 ☆Maxell CR2016 ☆Sanyo CR2016	Lithium battery		

Remarks :

Battery

☆ Matsushita BR2016 } The substitutive battery might be added to the applied battery in the future.
 ☆ Maxell CR2016 }In that case, please refer to separate "BATTERY LIST FOR SEIKO QUARTZ
 ☆ Sanyo CR2016 } WATCHES".

☆ ⇨ Please see remarks.

Part numbers in light letters are not shown in photos.

TECHNICAL GUIDE

SEIKO DIGITAL QUARTZ

CAL. C515A

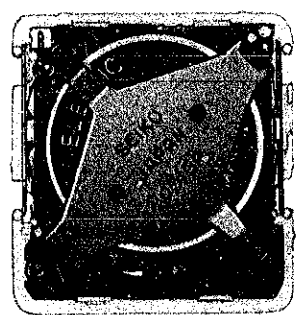
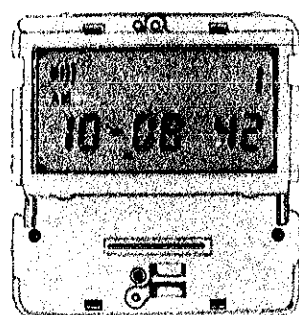

CONTENTS

I. SPECIFICATIONS	1
II. STRUCTURE OF CIRCUIT BLOCK	1
III. DISPLAY SYSTEM	2
IV. DISASSEMBLING, REASSEMBLING AND LUBRICATING	3
1. Disassembling, reassembling and lubricating of the case	3
2. Disassembling and reassembling of the module	5
V. CHECKING AND ADJUSTMENT	7
• Check battery voltage	7
• Check battery conductivity	7
• Check current consumption	7
• Check all segments lit up	8
• Check the contact of C-MOS-LSI – Liquid Crystal Panel	8
• Check liquid crystal panel and circuit block	8
• Check accuracy	9
• Check alarm test system	9
• Check alarm condition	9
• Check functioning and adjustment	10
• Check the conductivity of switch components	10
• Check water resistance	10
• Check functioning	10
• Check bulb condition	10

I. SPECIFICATIONS

Cal. No.		C515A
Item		
Display medium		Nematic liquid crystal, FEM (Field Effect Mode)
Liquid crystal driving system		Multiplex driving system
Display system		<ul style="list-style-type: none"> • Time and calendar display (12 or 24 hour indication) • Calculator function • Alarm function • Numerical memory function • Stopwatch function
Additional mechanism		<ul style="list-style-type: none"> • Alarm test system • Hourly time signal • Pattern segments checking system • Automatic return system • Illuminating light
Loss/gain		Loss/gain at normal temperature range Monthly rate: less than 15 seconds
Movement size	Outside diameter	25.0mm (between 3 o'clock and 9 o'clock sides) 26.5mm (between 6 o'clock and 12 o'clock sides)
	Height	5.2mm
Regulation system		Trimmer condenser
Measuring gate by quartz tester		Any gate is available
Battery		Lithium battery SANYO CR 2016, Maxell CR2016 and Matsushita BR2016 Voltage: 3.0V Battery life is approximately 3 years

II. STRUCTURE OF CIRCUIT BLOCK

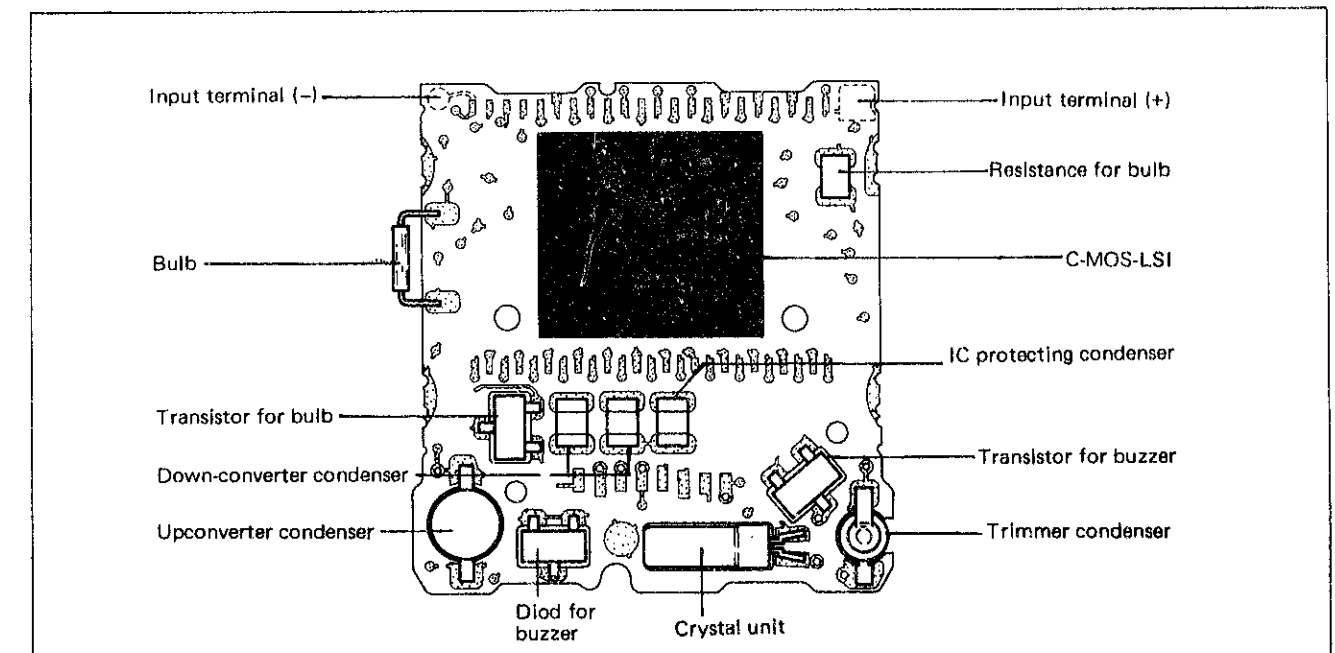

III. DISPLAY SYSTEM

By each depression of button "A", the function changes in the following order.

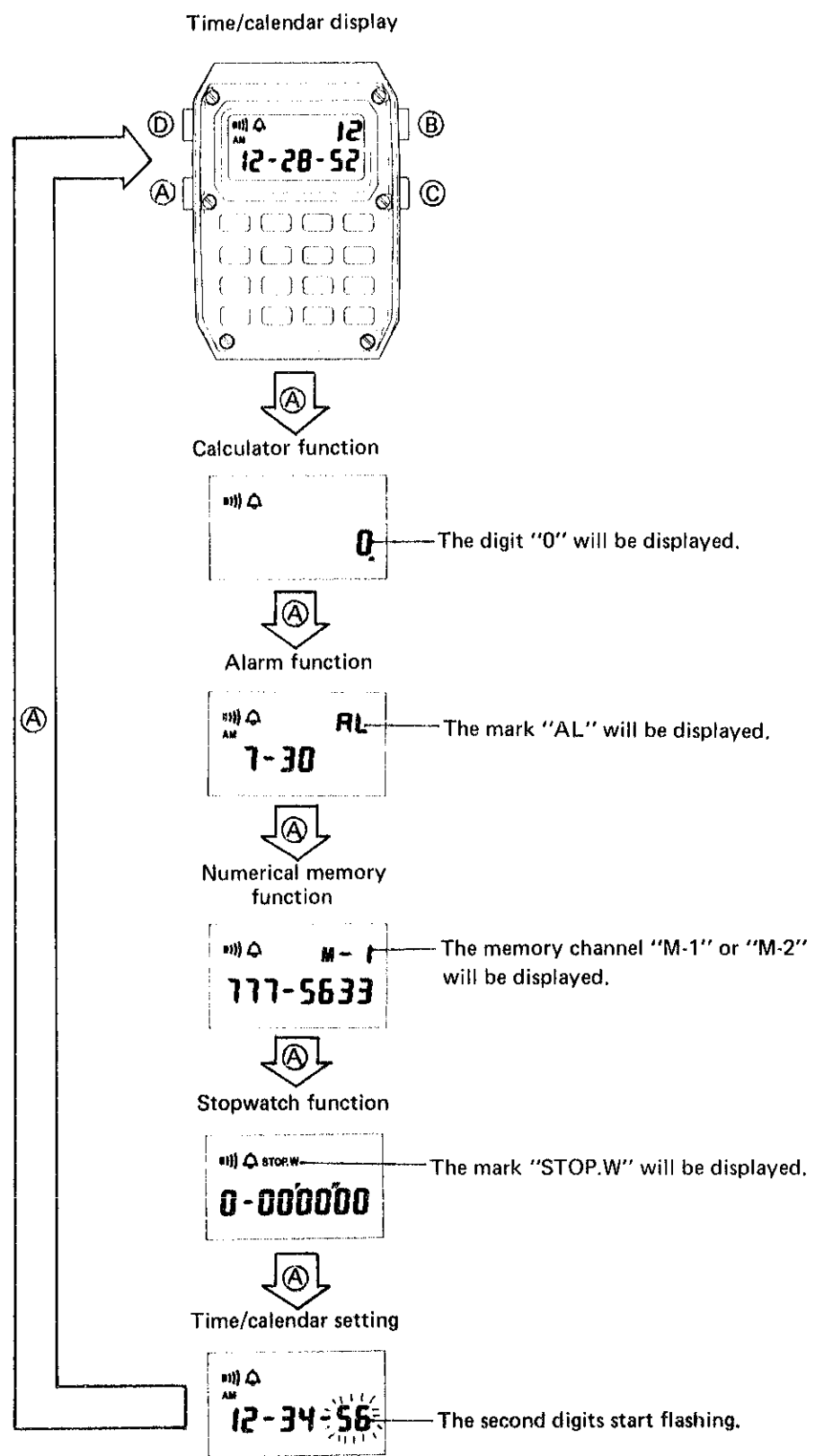

IV. DISASSEMBLING, REASSEMBLING AND LUBRICATING

1. Disassembling, reassembling and lubricating of the case

- Disassembling procedures: ① - ④
- Reassembling procedures: ④ - ①

Lubricating:
 Silicone grease 500,000 c.s.

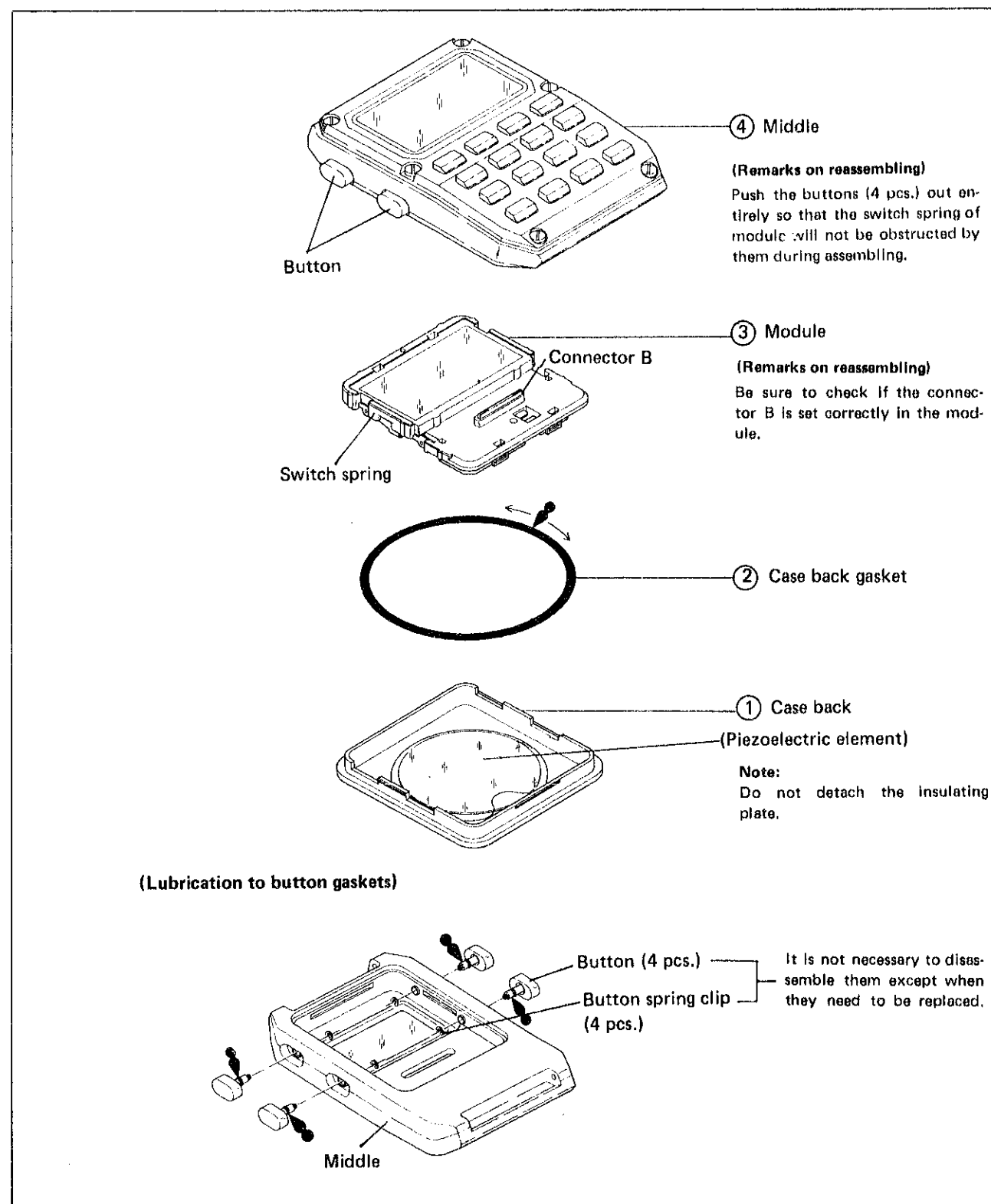

[Reassembling of key board portion]

It is not necessary to disassemble except for replacement.

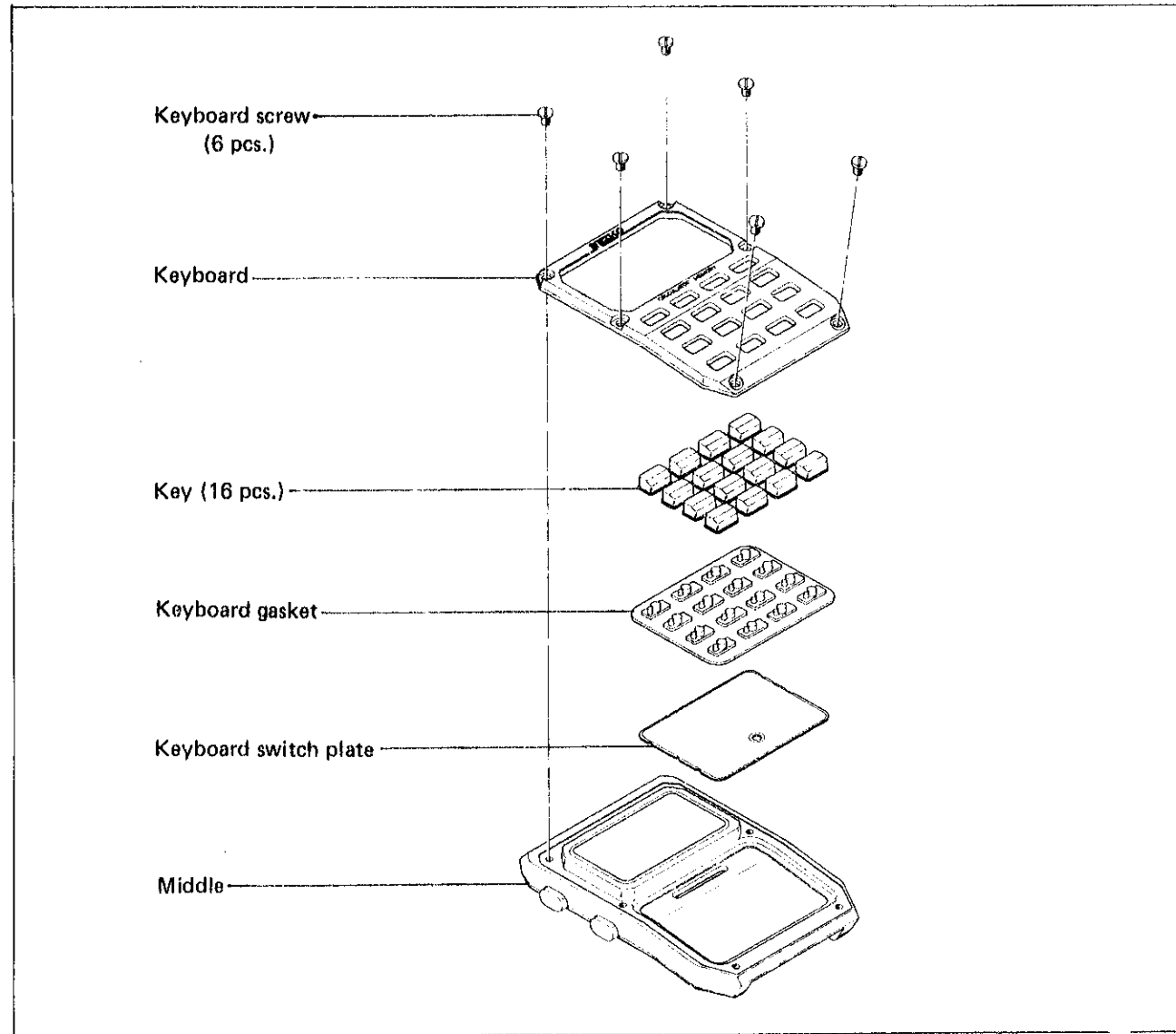

1) Set the keys on the keyboard gasket. (Fig. 1)

2) Set the keyboard gasket with keys to the keyboard.

3) Set the keyboard switch plate on the middle.

Note:
Set the keyboard switch plate in the guide groove of the middle stably. (Fig. 2)

4) Set the keyboard on the middle.

5) Tighten the keyboard screw (6 pcs.)
*Apply small quantity of rubberized adhesive to prevent the screws from loosening. (Fig. 3)

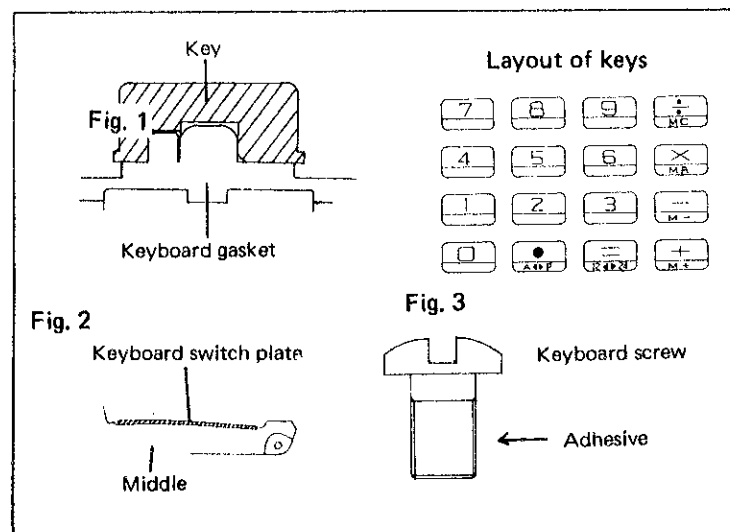

2. Disassembling and reassembling of the module

• Disassembling procedures: ① - ⑫ (Remove connector B first.)

• Reassembling procedures: ⑫ - ① (Reassemble the connector B last.)

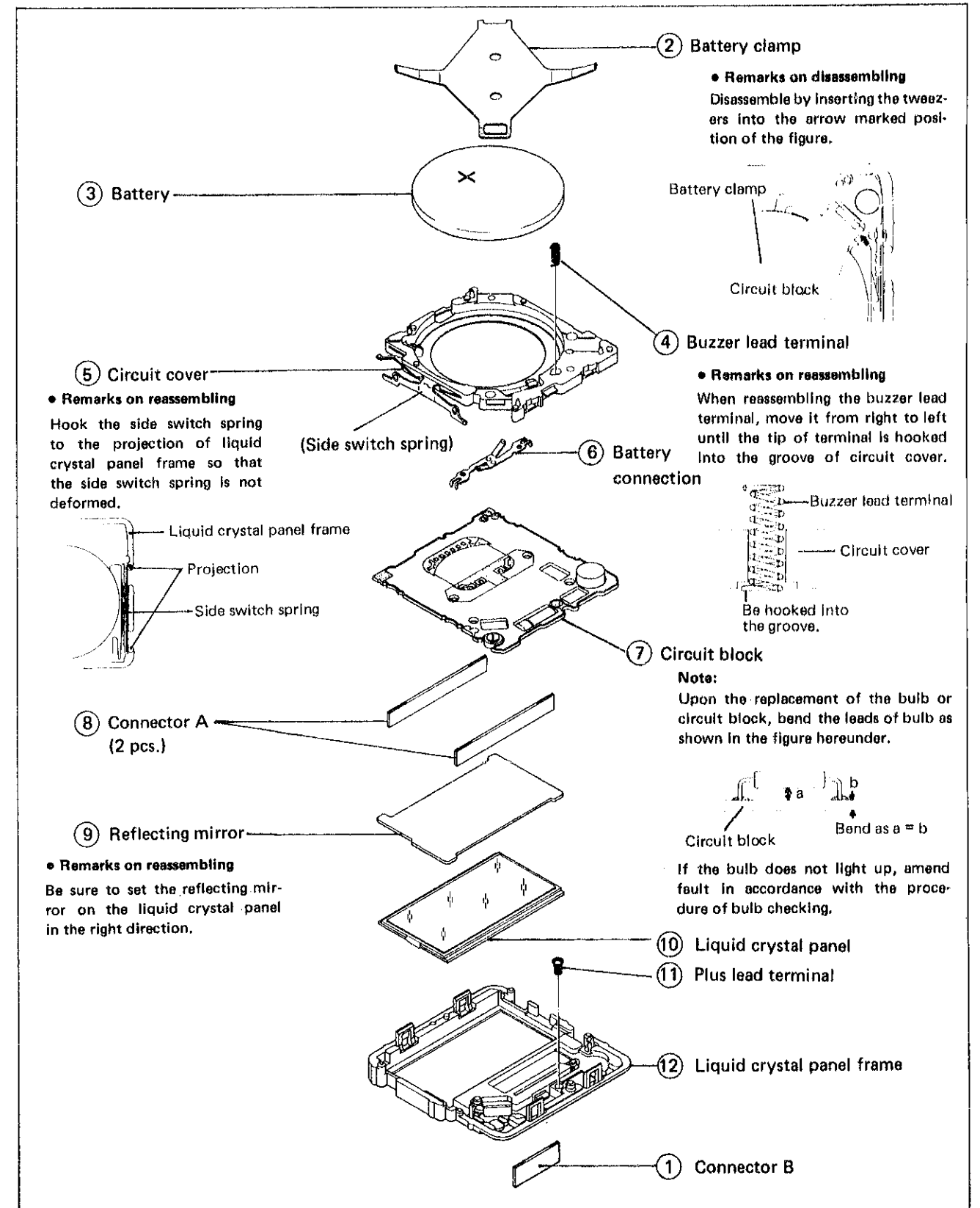

Relationship between the segment (liquid crystal panel electrode) and the C-MOS-LSI output terminal

● Designation of segment

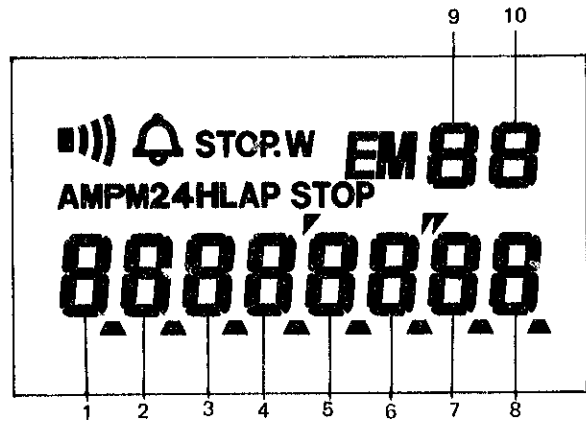
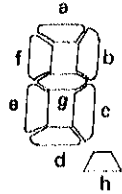

● Relationship between the segment and the C-MOS-LSI output terminal

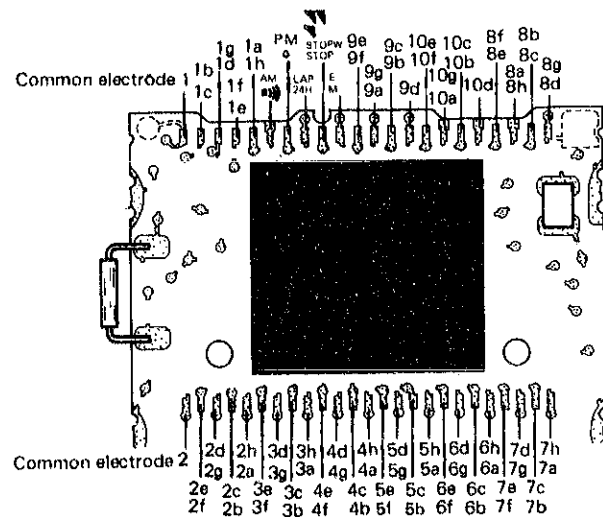
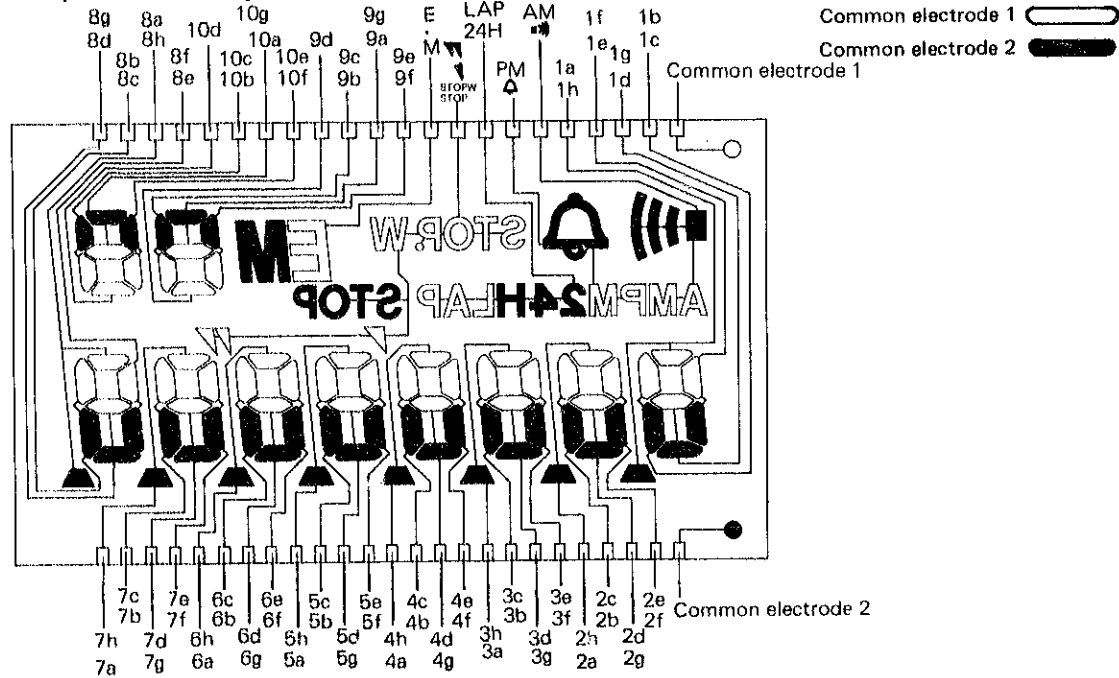

V. CHECKING AND ADJUSTMENT

The explanation here is particularly for the points of Cal. C515A. Refer to the "TECHNICAL GUIDE, GENERAL INSTRUCTION" for SEIKO Digital Quartz for details.

Procedure

CHECK BATTERY VOLTAGE

- Set up the volt-ohm-meter.
- Range to be used: DC 6V.

Result:
Normal : More than 2.8V
Defective: Less than 2.8V

CHECK BATTERY CONDUCTIVITY

CHECK CURRENT CONSUMPTION

- Set up the volt-ohm-meter
- Range to be used: DC 12 μ A
- Set the condenser kit of 200 ~ 500 μ F.
- Check in any function except calculator function.

1) Current consumption of the whole of module

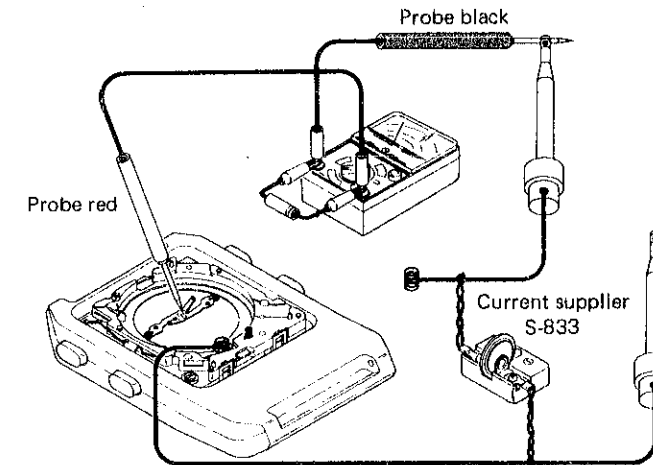

Result:
Normal : Less than 1.3 μ A
Defective: More than 1.3 μ A
Proceed to 2)

2) Current consumption of circuit block alone

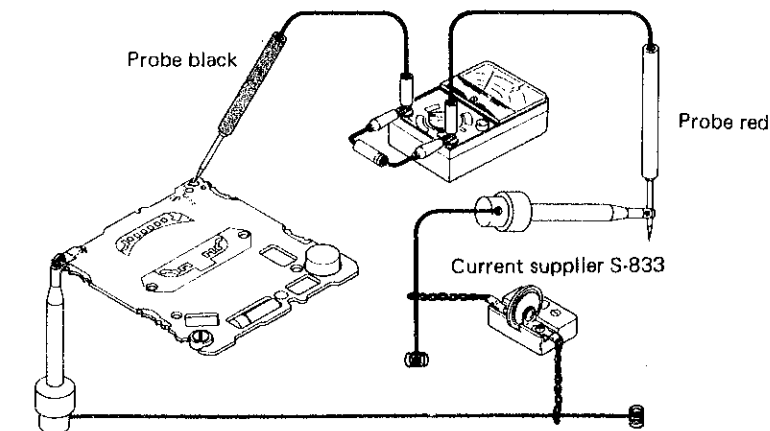

Result:
Normal : Less than 1.2 μ A
Replace liquid crystal panel
Defective: More than 1.2 μ A
Replace circuit block

Procedure

CHECK ALL SEGMENTS LIT UP

Check to see if all segments light up when the buttons "B" and "C" are depressed at the same time in time and calendar setting function.

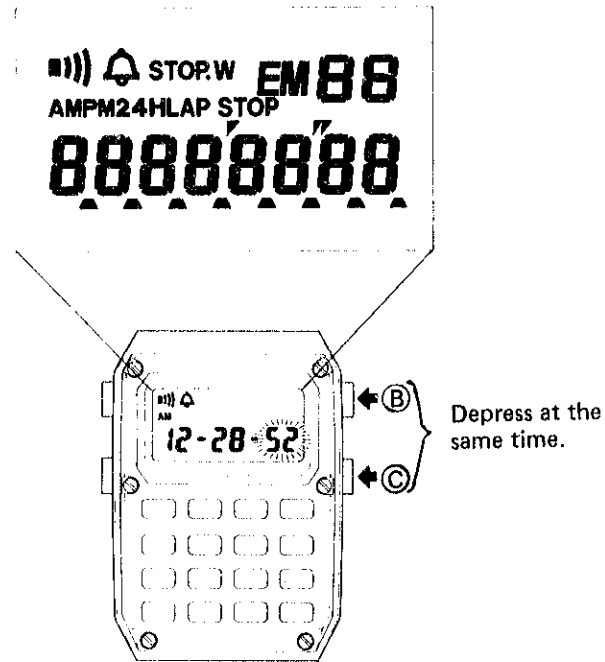

CHECK THE CONTACT OF C-MOS-LSI – LIQUID CRYSTAL PANEL

CHECK LIQUID CRYSTAL PANEL AND CIRCUIT BLOCK

- Set up volt-ohm-meter
- Range to be used: DC 3V
- How to check the output voltage of circuit block

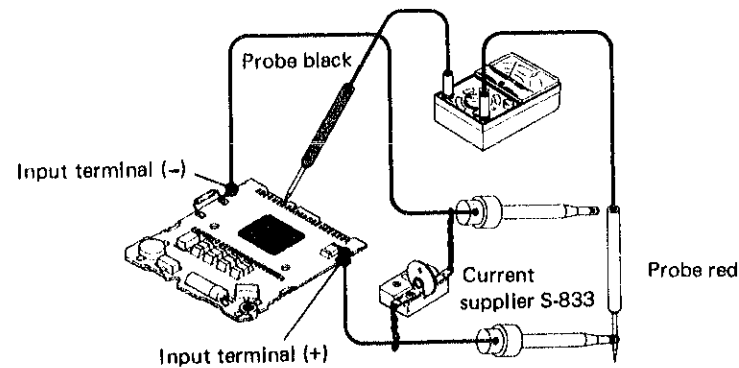

Result:
 Normal : More than 0.8V
 Defective: Less than 0.8V

Procedure

CHECK ACCURACY

- Measure the daily rate with all segments displayed by depressing the buttons "B" and "C" at the same time in the time and calendar setting function.
- If the reading is not stable, adjust it by rotating the level adjuster knob of the quartz tester.

CHECK ALARM TEST SYSTEM

- Check to see if the alarm rings when the buttons "B" and "C" are depressed at the same time in time and calendar display.

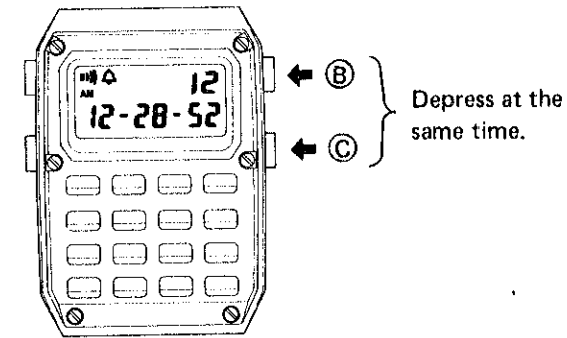

Result:
 Normal : Alarm sounds
 Defective: Alarm does not sound
 Check alarm condition.

CHECK ALARM CONDITION

- Check up converter coil
 Measure the resistance of upconverter coil and check to see if there is any breaking of wire or short circuit.

Set up Volt-ohm meter
 Range to be used: OHM x 1

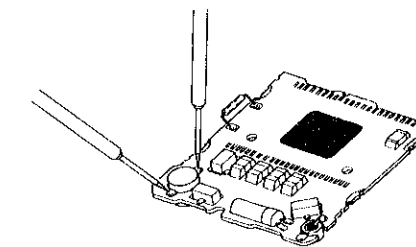

Result:
 Normal : 40 ~ 80 Ω
 Defective: Less than 40Ω
 More than 80Ω

Procedure

● Check the output voltage of alarm

Check to see if the output voltage for the alarm is conducted from the circuit block while depressing buttons "B" and "C".

Set up volt-ohm meter.
Range to be used: DC 3V

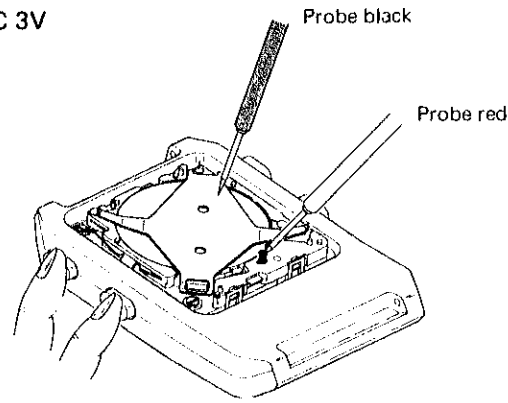

Result:

Normal : The pointer swings slightly
Defective: The pointer does not swing

*When there is no defect to be found through the checking methods above, check the piezoelectric element for break, crack, etc.

CHECK FUNCTIONING AND ADJUSTMENT

CHECK THE CONDUCTIVITY OF SWITCH COMPONENTS

CHECK WATER RESISTANCE

CHECK FUNCTIONING

CHECK BULB CONDITION

Note: If the bulb does not light up, it may often be caused by the short circuit made by the bad contact between the leads of bulb and the side switch spring.
Amend by pushing the leads of bulb with tweezers through the side space of liquid crystal panel frame.

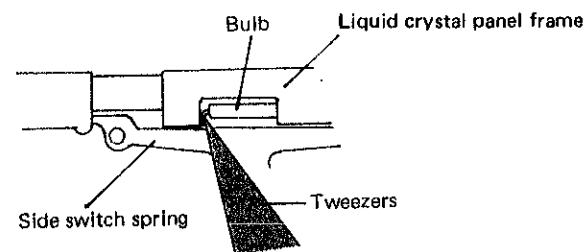

All procedures of Disassembling, Reassembling, Lubricating, Checking and Adjustment are completed.