

# ETA F07.111

COMMUNICATION  
TECHNIQUE

TECHNISCHE  
MITTEILUNG

TECHNICAL  
COMMUNICATION

1 3/4'''

<p>1 3/4''' Ø 30,00 mm</p>		
<p>Hauteur sur mouvement Höhe auf Werk Height on movement</p>	<p>2,50 mm</p>	
<p>Hauteur sur pile (No 371) Höhe auf Batterie Height on battery(No 395)</p>	<p>2,62 mm 3,22 mm</p>	
<p>Nombre de rubis / Anzahl Rubine / Number of jewels Fréquence / Frequenz / Frequency</p>		

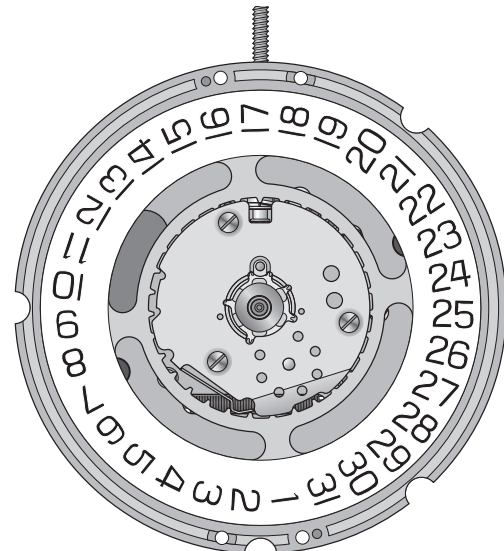
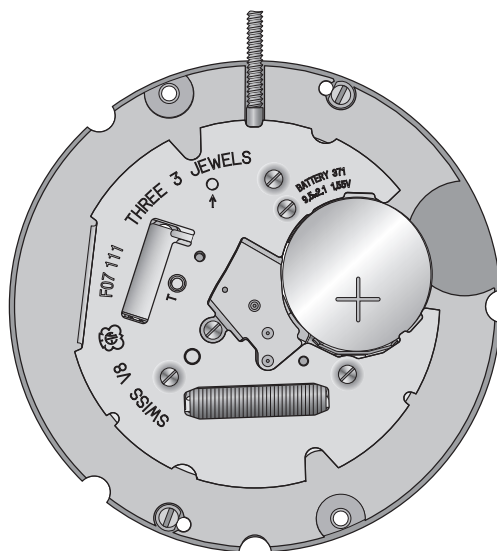

Mouvement quartz

Quarzwerk

Quartz movement











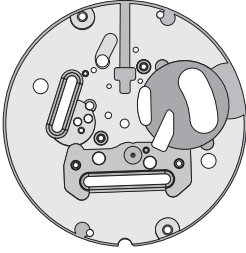
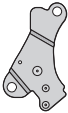

















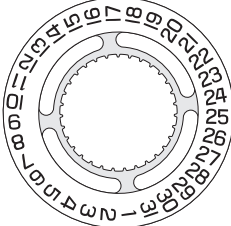
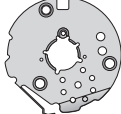
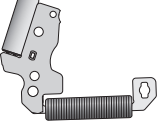

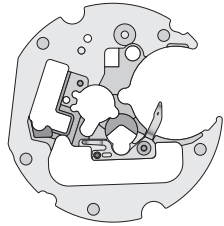

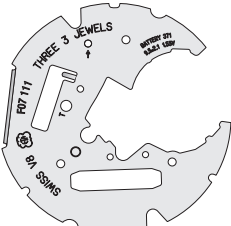

**ETA** SA  
MANUFACTURE HORLOGÈRE SUISSE  
DEPUIS 1793

## Interchangeabilité - Auswechselbarkeit - Interchangeability

No Nr No	No Nr No	CS	LISTE DES FOURNITURES	BESTANDTEILE	LIST OF MATERIALS	Cal. Kal. Cal.
100	10.020.00		Platine	Werkplatte	Main plate	F07.111
110	10.048.07		Pont de rouage, empierré	Räderwerkbrücke, mit Steinen	Train wheel bridge, jewelled	F03.111
203	30.012.00		Roue intermédiaire	Zwischenrad	Intermediate wheel	F03.111
210	30.025.00		Roue moyenne	Kleinbodenrad	Third wheel	F03.111
227	30.027.00		Roue de seconde	Sekundenrad	Second wheel	F03.111
242	31.083.00		Chaussée avec roue entraîneuse	Minutenrohr mit Mitnehmerrad	Cannon pinion with driving wheel	F03.111
255/1	31.046.06		Roue des heures, montée	Stundenrad, montiert	Hour wheel, assembled	F03.111
260	31.041.00		Roue de minuterie	Wechselrad	Minute wheel	F03.111
405	51.020.21		Tige de mise à l'heure, diamètre filetage 0,90 mm	Stellwelle, Gewindedurchmesser 0,90 mm	Handsetting stem, thread diameter 0.90 mm	F05.111
407	31.121.00		Pignon coulant	Kupplungstrieb	Sliding pinion	F03.111
435	51.050.00		Bascule	Hebel	Yoke	F03.111
443/1	51.080.06		Tirette montée	Winkelhebel, montiert	Setting lever, assembled	F03.111
445	51.090.00		Sautoir de tirette	Winkelhebelraste	Setting lever jumper	F03.111
462	10.062.00		Pont de rouage de minuterie	Wechselradbrücke	Minute train bridge	F03.111
2556	33.020.00		Roue entraîneuse de l'indicateur de quantième	Datumanzeiger-Mitnehmerrad	Date indicator driving wheel	F03.111
2557/1	91.440.22		Indicateur de quantième, ouverture de guichet à 3 h	Datumanzeiger, für Fenster bei 3 Uhr	Date indicator, for opening at 3 o'clock	F07.111
2595	13.111.00		Plaque de maintien avec sautoir de quantième	Halteplatte mit Datumraste	Maintaining plate with date jumper	F03.111
4000	10.513.00		Module électronique	Elektronik-Baugruppe	Electronic module	F03.111
4021	20.582.00		Stator	Stator	Stator	F03.111
4022	80.102.00		Entretoise	Zwischenstück	Distance piece	F05.111
4038	20.584.00		Couvre-module électronique	Deckplatte für Elektronik-Baugruppe	Electronic module cover	F07.111
4046	20.651.00		Isolateur de pile	Isolation für Batterie	Battery insulator	F05.111
4211	20.580.00		Rotor	Rotor	Rotor	F03.111
4407	20.764.00		Bride +	Bügel +	Bridle +	F05.111
4412	10.601.00		Ressort de limitation de pile	Begrenzungsfeder für Batterie	Battery limiting spring	F05.111
4929	20.570.00		Pile, H. 2,05 mm	Batterie, H. 2,05 mm	Battery, H. 2.05 mm	F05.111
4929/1	20.570.18		Pile spéciale, H. 2,70 mm	Batterie, Spezial-Ausführung, H. 2,70 mm	Battery, special, H. 2.70 mm	F05.111
5101	10.020.01		Vis de fixation	Schraube für Werkbefestigung	Screw for case	F03.111
5102	10.020.02		Vis de fixation, spéciale	Schraube für Werkbefestigung, Spezial-Ausführung	Screw for case, special	F03.111
1)	5110	2x	Vis de pont de rouage	Schraube für Räderwerkbrücke	Screw for train wheel bridge	F03.111
	5445	1x	Vis de sautoir de tirette	Schraube für Winkelhebelraste	Screw for setting lever jumper	F03.111
2)	5462	1x	Vis de pont de rouage de minuterie	Schraube für Wechselradbrücke	Screw for minute train bridge	F03.111
2)	52595	3x	Vis de plaque de maintien du sautoir de quantième	Schraube für Halteplatte für Datumraste	Screw for date jumper maintaining plate	F03.111
1)	54000	3x	Vis du couvre-module électronique	Schraube für Deckplatte für Elektronik-Baugruppe	Screw for electronic module cover	F03.111
			<b>Vis identiques Identische Schrauben Identical screws</b>	<b>1) 5110 54000</b>	<b>2) 5462 52595</b>	

## Fournitures - Bestandteile - Materials

										5101
100	110	203	210	227	242	255/1	260			
										5102
405	407	435	443/1	445	462	2556				
										5110 54000
2557/1	2595	4000	4021	4022						
										5445
4038	4046	4211	4407	4412	4929 H 2,15 mm	4929/1 H 2,60 mm				5462 52595

**Montage du mouvement de base et de la partie électronique**

(Liste des fournitures par ordre d'assemblage)

**Zusammenstellen des Basiswerkes und des elektronischen Teils**

(Bestandteilliste in Montager Reihenfolge)

**Assembling of the basic movement and the electronic part**



(Parts listed in order of assembly)

100	4022	4000
407	4211	4407
405	203	4038
443/1	210	54000 (3x)
435	227	4929 - 4929/1
445	110	4412
5445	5110 (2x)	
4021	4046	

**M<sub>L</sub> Couple minimum pour dévisser**  
**M<sub>L</sub> Minimales Drehmoment zum Lösen**  
**M<sub>L</sub> Minimum torque for loosening**

- (b) 0,7 Ncm
- (c) 1,8 Ncm

**Lubrification – Schmierung – Lubrication**

-  Huile fine  
Dünnflüssiges Öl  
Fine oil **Moebius 9014**  
ou / oder / or **Moebius 9034**
-  Très petite quantité  
Sehr kleine Menge  
Very small quantity **Moebius 9014**  
ou / oder / or **Moebius 9034**
-  Huile épaisse à viscosité élevée ou graisse  
Dickflüssiges druckfestes Öl oder Fett  
Thick, pressure-resistant oil or grease **Moebius D5**  
ou / oder / or **HP 1300**

**4412**

Nécessaire, si la sûreté entre le mouvement et le fond de la boîte est trop élevée.

Nur nötig, wenn der Abstand Werk Gehäuseboden zu gross ist.

To be fitted when the distance between the movement and the case back is too big.

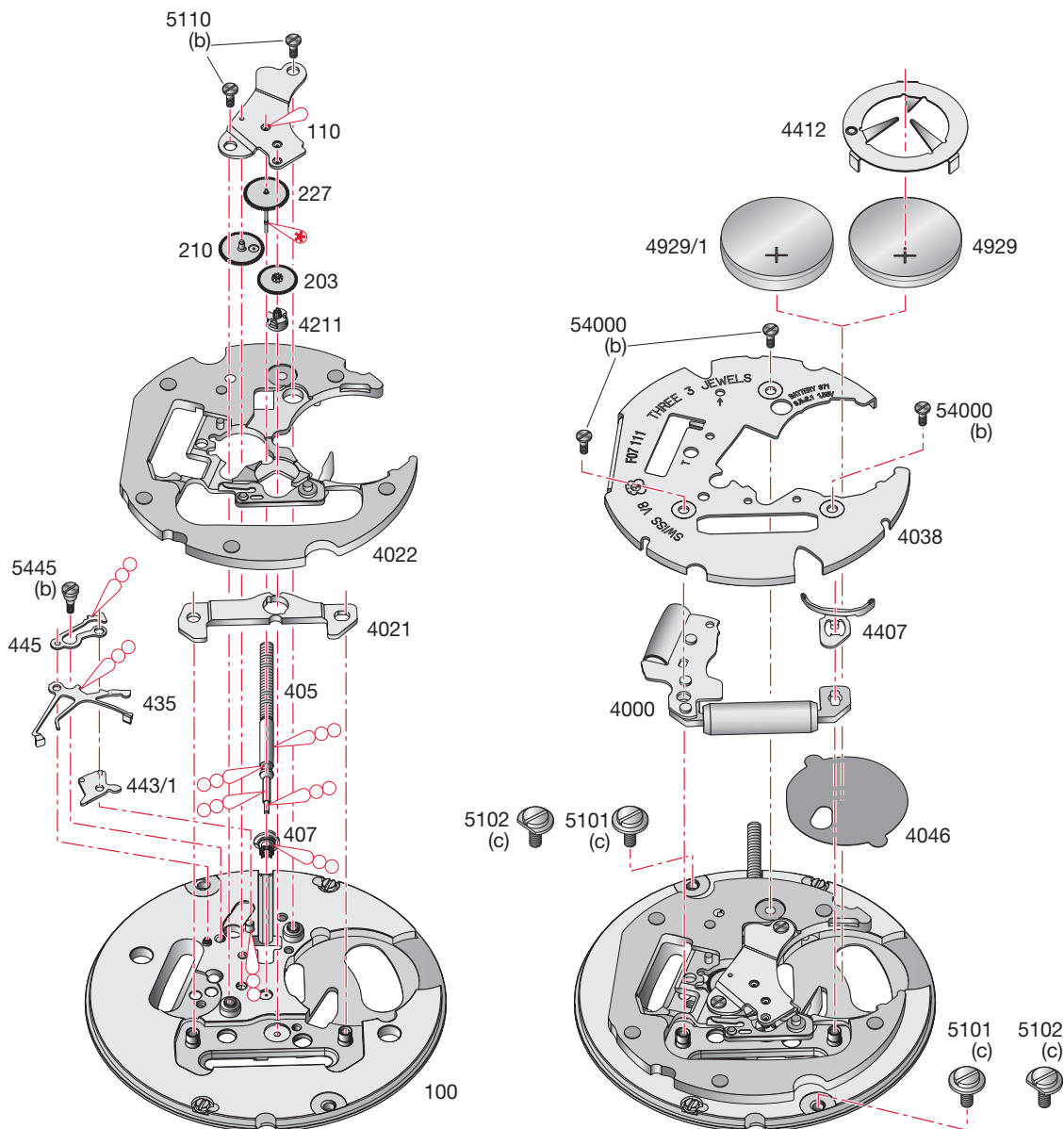

**Montage du mécanisme de mise à l'heure et du mécanisme de calendrier**

(Liste des fournitures par ordre d'assemblage)

**Zusammenstellen des Zeigerwerkmechanismus und des Kalendermechanismus**

(Bestandteilliste in Montager Reihenfolge)

**Assembling of the handsetting and the calendar mechanism**

(Parts listed in order of assembly)

100	255/1
242	2556
260	2557/1
462	2595
5462	52595 (3x)

**Lubrification – Schmierung – Lubrication**

 Huile fine  
Dünflüssiges Öl  
Fine oil

**Moebius 9014**  
ou / oder / or  
**Moebius 9034**

 Très petite quantité  
Sehr kleine Menge  
Very small quantity

**Moebius D5**  
ou / oder / or  
**HP 1300**

 Graisse  
Fett  
Grease

**Moebius 9501**  
ou / oder / or  
**Jismaa 124**

 Graisse  
Fett  
Grease

**Moebius 8212 SC**

**M<sub>L</sub> Couple minimum pour dévisser**  
**M<sub>L</sub> Minimales Drehmoment zum Lösen**  
**M<sub>L</sub> Minimum torque for loosening**

(a) 0,6 Ncm

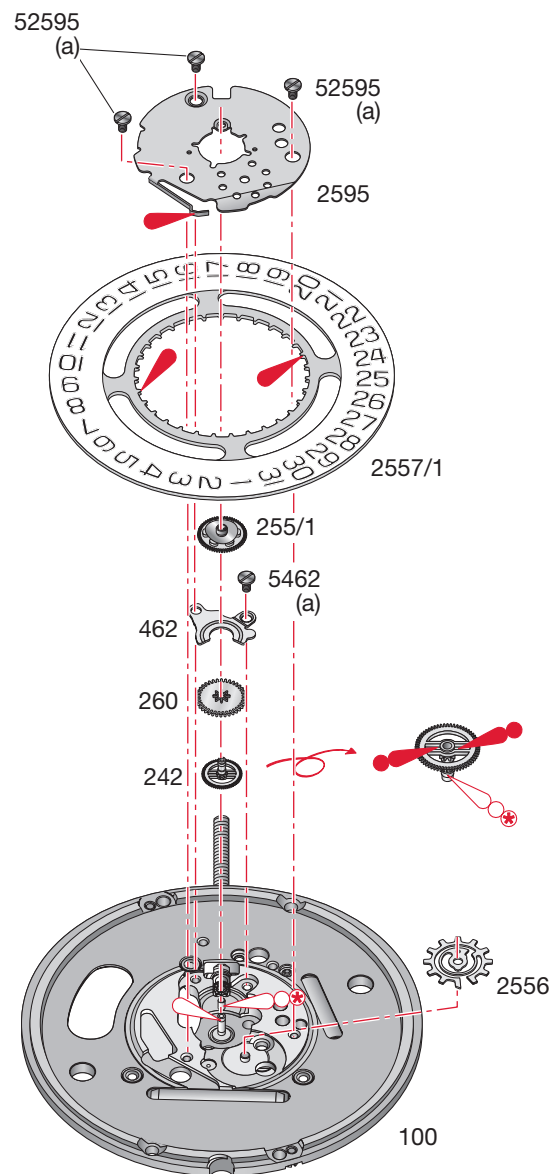

## Contrôles électriques – Elektrische Kontrollen – Electrical Tests

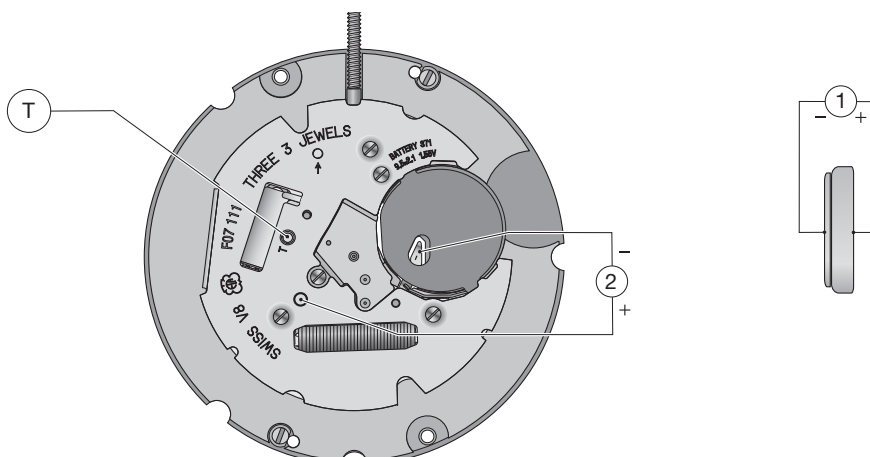

Position Messpunkt Position	Echelle de mesure Einstellung Messgerät Setting of apparatus	Mesure Messung Measurement	Contrôle Kontrolle Test	Remarques Bemerkungen Remarks
<b>1</b>	2 V	1,55 V	Tension de la pile Spannung der Batterie Battery voltage	
<b>2</b>	2 V	1,30 V  Mettre en contact le point <b>T</b> et la piste -. Commande du moteur avec 8 pas/s à 1,55 V et 16 pas/s avec tension $\leq 1,30$ V (E.O.L.).  <b>T</b> Punkt mit der - Spur verbinden. Motorantrieb mit 8 Schritten/s bei 1,55 V und 16 Schritten/s mit Spannung $\leq 1,30$ V (E.O.L.).  Connect <b>T</b> point with the - conductor. Motor driven with 8 steps/s at 1.55 V and 16 steps/s with voltage $\leq 1.30$ V (E.O.L.)	Limite inférieure de la tension de fonctionnement  Untere Funktionsspannungsgrenze  Lower working-voltage limit	Mesure sans pile, alimentation extérieure variable, en descendant de 1,55 V jusqu'à l'arrêt du mouvement.  Messung ohne Batterie mit variabler Speisung von aussen, Spannung von 1,55 V reduzieren bis zum Stillstand des Werkes.  Measurement without battery, with variable external power supply, starting with 1.55 V, lower tension until movement stops.
	10 $\mu$ A	$\leq 1,10 \mu$ A	Consommation du mouvement  Stromaufnahme Uhrwerk  Consumption of movement	Mesure sans pile, avec alimentation extérieure 1,55 V.  Messung ohne Batterie, mit Speisegerät 1,55 V.  Measurement without battery, with external power supply 1.55 V.
	10 $\mu$ A	Saut de 4 pas toutes les 4 sec. lorsque la tension d'alimentation $< 1,30$ V.  4-Schritte-Sprung alle 4 Sek., wenn Speisespannung $< 1,30$ V.  4 steps jump every 4 sec., when feed voltage $< 1.30$ V.	E.O.L. Consommation supérieure à la valeur normale.  E.O.L. Stromaufnahme über Normalwert.  E.O.L. Consumption higher than in normal operation.	Mesure sans pile, avec tension d'alimentation $< 1,30$ V, Fonction E.O.L. après ~ 2 min.  Messung ohne Batterie, mit Speisespannung $< 1,30$ V, E.O.L.-Funktion nach ca. 2 Min.  Measurement without battery, with feed voltage $< 1.30$ V, E.O.L. function after about 2 min.
	10 $\mu$ A	$\leq 0,5 \mu$ A	Fonctionnement de l'interrupteur en pos. 3 de la tige de mise à l'heure.  Funktion des Stopphebels, Pos. 3 der Zeigerstellwelle.  Function of stop lever, pos. 3 of handsetting stem.	Mesure sans pile, avec alimentation extérieure 1,55 V.  Messung ohne Batterie, mit Speisegerät 1,55 V.  Measurement without battery, with external power supply 1.55 V.

*Température ambiante 20°C - 25°C.  
Raumtemperatur 20°C - 25°C.  
Ambient temperature 20°C - 25°C.*

We reserve all rights for this document. It is meant for the recipient only and it may not be copied, printed or given to a third person without our written permission.

Für dieses Dokument behalten wir uns alle Rechte vor. Es ist nur für den Empfänger bestimmt. Ohne unsere schriftliche Bewilligung darf es nicht kopiert, vervielfältigt und Dritten zugänglich gemacht werden.

Nous nous réservons tous les droits sur ce document. Il est confié au destinataire. Il ne peut, sans notre autorisation écrite, être copié, reproduit, communiqué à des tiers.

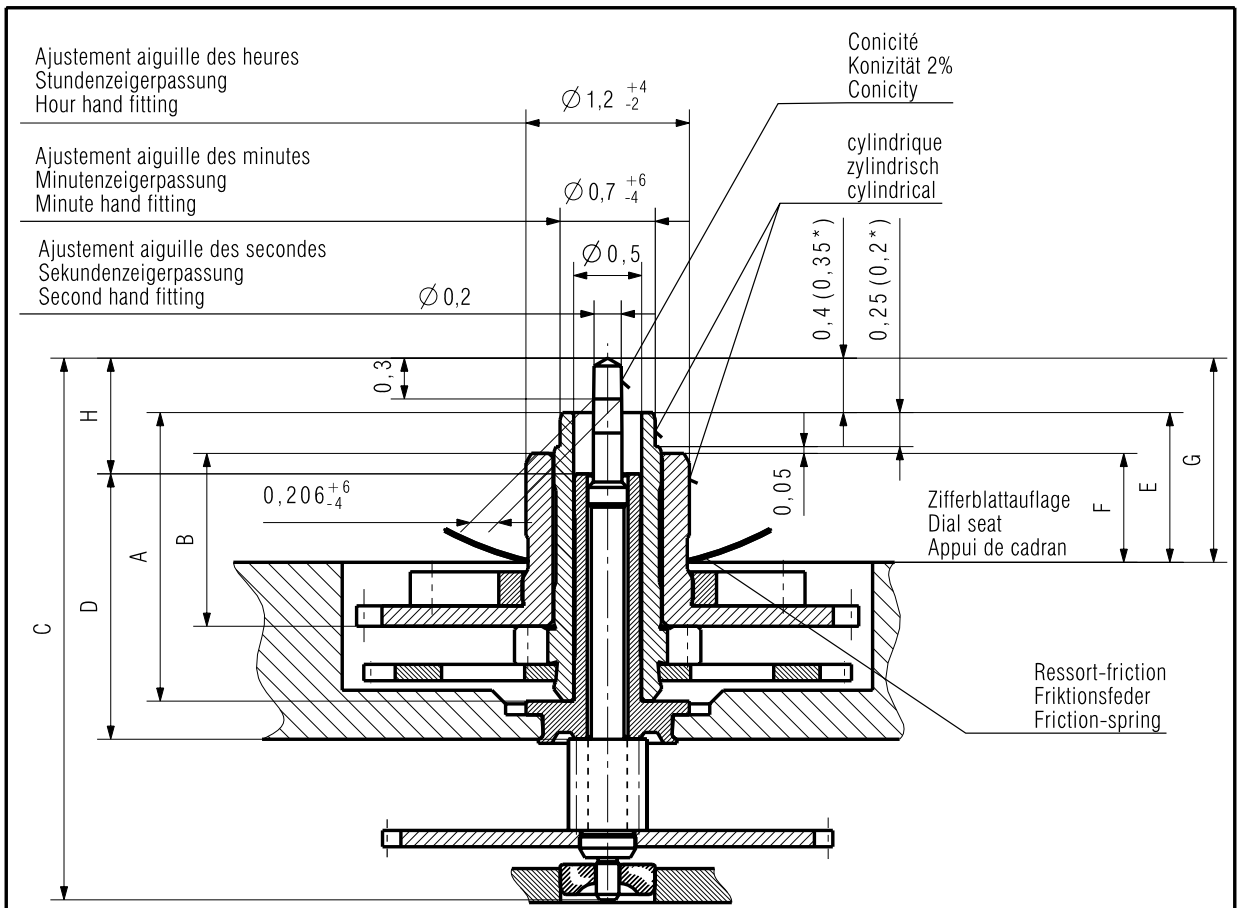

\*\* Livraison contre supplément de prix  
Lieferung gegen Aufpreis  
Delivery with surcharge

Aiguillage Zeigerwerkhöhe Hand fitting height	Longueur/Länge/Length				Dépassement Höhe über Zifferblattaufgabe Height over dial seat			H	Ep.cadran Zifferblattdicke Dial thickness	
	A	B	C	D	E	F	G			
réduit * niedrig * reduced *	1,9	1,1	3,73	1,95	0,9	0,65	1,25	0,6	0,3	
1 normal	2,12	1,27	3,98	1,95	1,1	0,8	1,5	0,85		
3 **	2,62	1,77	4,48	1,95	1,6	1,3	2	1,35		
Aiguilles Zeiger Hands					Aiguille d'heure Stundenzeiger Hour hand		Aiguille de minute Minutenzeiger Minute hand	Aiguille de seconde Sekundenzeiger Second hand		
Masse/Masse/Mass	max.				mg	30	30	10		
Balourd/Unwucht/Unbalance	max.				µNm	0,8	0,8	0,036		
Force de chassage/Setzkraft/Press-in force	max.				N	30	30	30		
Kaliber / Calibre / Caliber F03111 / F04111 / F05111 / F06111 / F07111 F05711 / F06711						Masstab Echelle Scale --		CATIA V5 Masse in mm Dimensions en mm Dimensions in mm Tol.1/1000 mm		
AIGUILLAGES ZEIGERWERKHÖHEN HAND FITTING HEIGHTS						Z0047367		Version 05	Revision 00	Blatt Feuille Sheet 01/01
ETA SA MANUFACTURE HORLOGÈRE SUISSE DEPUIS 1793 A COMPANY OF THE SWATCH GROUP				Ersatz für/En remplacement de/Remplacement for Aenderung/Modification 21662		Klass. ZVACC		KUN		
				Erstellt Etabli Created 09.03.2007 ZWJ		Geprüft Contrôlé Controlled 09.03.2007 WIR		Freigegeben Libéré Released 09.03.2007 VET		

Stundenzeigerpassung  
Hour hand fitting  
Ajustement aiguille des heures

Minutenzeigerpassung  
Minute hand fitting  
Ajustement aiguille des minutes

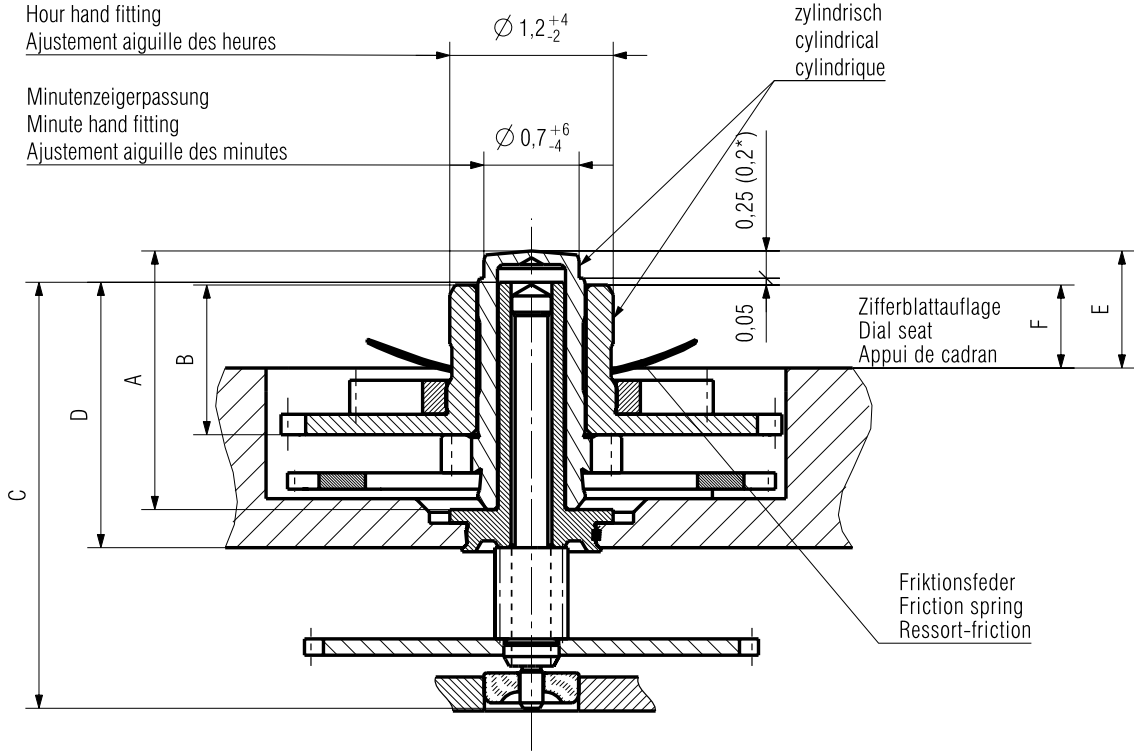

\*\* Livraison contre supplément de prix  
Lieferung gegen Aufpreis  
Delivery with surcharge

Aiguillage Zeigerwerkhöhe Hand fitting height	Longueur/Länge/Length				Dépassement Höhe über Zifferblattaufgabe Height over dial seat		Ep.cadran Zifferblattstärke Dial thickness
	A	B	C	D	E	F	
	Chaussée Minutenrohr Cannon-pinion	Roue des heures Stundenrad Hour wheel	Pig.des sec. Sekundentrieb Sec.wheel pin.	Tube de centre Zentrumrohr Centre tube	Chaussée Minutenrohr Cannon-pinion	Roue des heures Stundenrad Hour wheel	
réduit * niedrig * reduced *	1,9	1,1	3,13	1,95	0,9	0,65	0,3
1 normal	2,12	1,27	3,13	1,95	1,1	0,8	
3 **	2,62	1,77	3,13	1,95	1,6	1,3	

Aiguilles Zeiger Hands	Aiguille d'heure Stundenzeiger Hour hand		Aiguille de minute Minutenzeiger Minute hand	
Masse/Masse/Mass	max.	mg	30	30
Balourd/Unwucht/Unbalance	max.	$\mu$ Nm	0,8	0,8
Force de chassage/Setzkraft/Press-in force	max.	N	30	30

Kaliber / Calibre / Caliber F03111 / F04111 / F05111 / F06111 / F07111 F05711 / F06711	Massstab Echelle Scale --		CATIA V5
		Masse in mm Dimensions en mm Dimensions in mm	Tol.1/1000 mm

AIGUILLAGES ZEIGERWERKHÖHEN HAND FITTING HEIGHTS	SANS SECONDE OHNE SEKUNDE WITHOUT SECONDS	Version 04	Revision 00	Blatt Feuille Sheet 01/01
--	---	---------------	----------------	------------------------------------

<b>ETA</b> SA MANUFACTURE HORLOGÈRE SUISSE DEPUIS 1793  A COMPANY OF THE <b>SWATCH GROUP</b>	Ersatz für/En remplacement de/Remplacement for	Klass. Class. <b>ZVACC</b>	KUN	
	Aenderung/Modification 21662	Erstellt Etabli Created 09.03.2007 ZWJ	Geprüft Contrôlé Controlled 09.03.2007 WIR	Freigegeben Libéré Released 09.03.2007 VET

Nous nous réservons tous les droits sur ce document. Il est confié au destinataire. Il ne peut, sans notre autorisation écrite, être copié, reproduit, communiqué à des tiers.

Für dieses Dokument behalten wir uns alle Rechte vor. Es ist nur für den Empfänger bestimmt. Ohne unsere schriftliche Bewilligung darf es nicht kopiert, vervielfältigt und Dritten zugänglich gemacht werden.

We reserve all rights for this document. It is meant for the recipient only and it may not be copied, printed or given to a third person without our written permission.



Cette page est laissée blanche intentionnellement.

Diese Seite wird absichtlich weiss gelassen.

This page was left blank intentionally.

Cette page est laissée blanche intentionnellement.

Diese Seite wird absichtlich weiss gelassen.

This page was left blank intentionally.

Cette page est laissée blanche intentionnellement.

Diese Seite wird absichtlich weiss gelassen.

This page was left blank intentionally.

*Modifications comparées aux  
versions précédentes du document*

*Änderungen gegenüber vorher-  
gehenden Dokumentenversionen*

*Modifications compared with  
previous document versions*

Version	Date Datum Date	Modification	Änderung	Modification	Page Seite Page
00	15.03.07	Version de base	Basis Version	Basic version	--



**ETA** SA  
MANUFACTURE HORLOGÈRE SUISSE  
DEPUIS 1793

CUSTOMER SERVICE

Bahnhofstrasse 9  
P.O. Box 427  
2540 Grenchen  
Schweiz

Tel +41 (0)32 655 72 77  
Fax +41 (0)32 655 84 30

etacs@eta.ch  
www.eta.ch