

SEIKO

DIGITAL QUARTZ

Cal. L012A

PARTS LIST

Cal. L012A

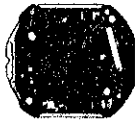

4001 084



4216 041



4225 018



4245 019



4270 021



4313 018

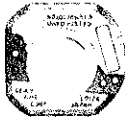

4398 032



4453 002

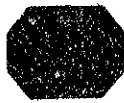

4510 001



4521 015
4521 017



SEIKO SB-AP

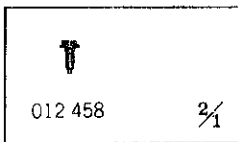

012 458

$\frac{3}{4}$

Cal. L012A

Characteristics

Casing diameter : ϕ 17.50 mm
 Maximum height : 4.83 mm
 Frequency of quartz crystal oscillator : 32,768 Hz (Hz=Hertz Cycle per second)
 Time functions : 12-hour Digital Display System showing hour and minute (The dots blink once every second) The second digits are displayed by depressing the side button when the calendar digits are displayed.
 Calendar functions : The month and date are displayed for 2 seconds by depressing the side button
 Display medium : Nematic Liquid Crystal, FE-Mode
 Time micro-adjustor : Trimmer condenser system
 Battery life indicator : The entire display begins flashing

PART NO.	PART NAME	PART NO.	PART NAME
4001 084	Circuit block (with liquid crystal panel frame)		
4216 041	Insulating sheet for battery		
4225 018	Holding ring for battery		
4245 019	Switch spring		
4270 021	Battery connection		
4313 018	Connector		
4398 032	Battery guard		
4453 002	Spacer for connector		
4510 001	Liquid crystal panel		
4521 015	Reflecting mirror (Silver)		
4521 017	Reflecting mirror (Gold)		
012 458	Screw for battery holding spring		
SEIKO SB-AP	Silver oxide battery		

TECHNICAL GUIDE

SEIKO

DIGITAL QUARTZ

CAL. L012A

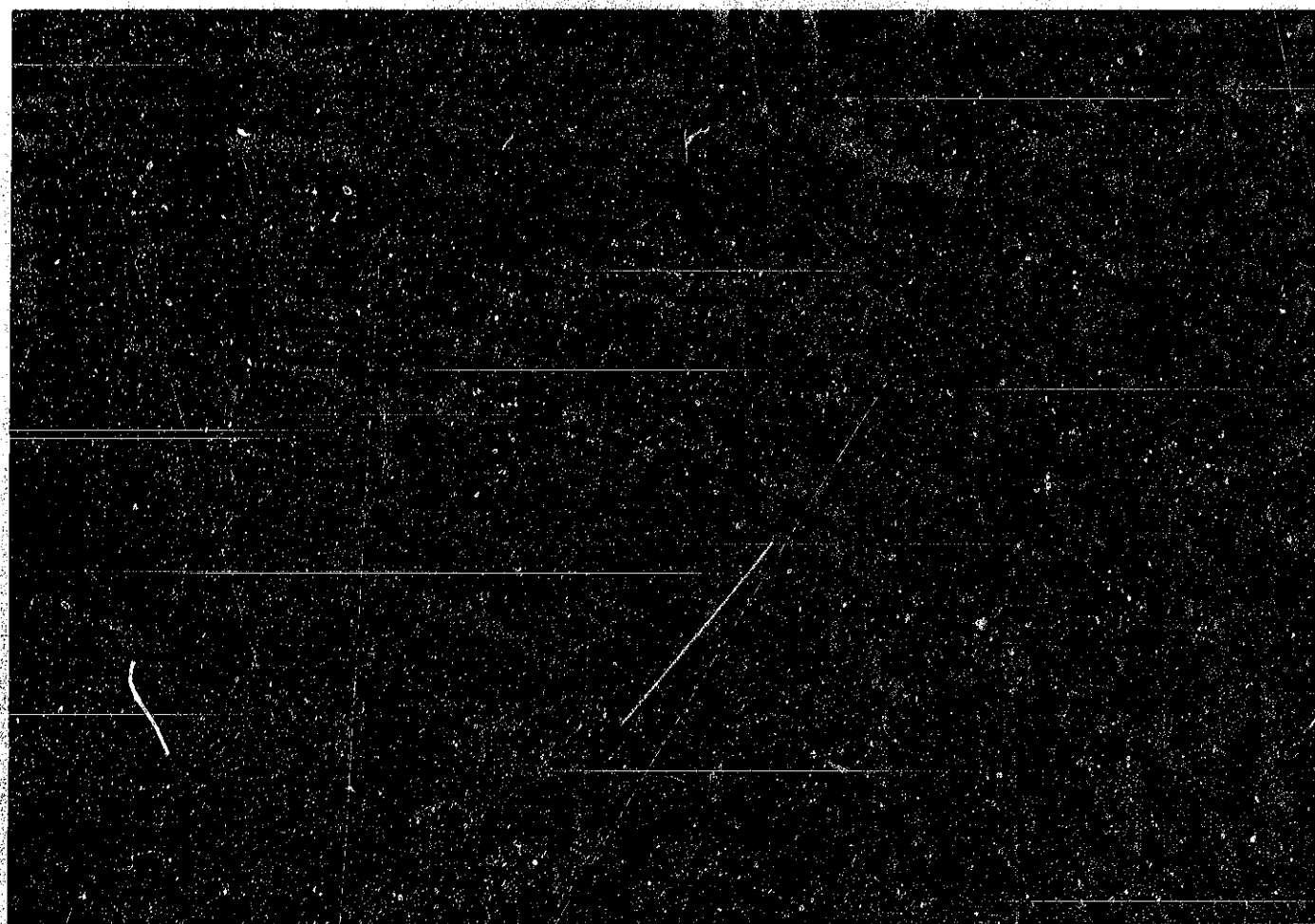

CONTENTS

I. SPECIFICATIONS AND FEATURES	2
1. Specifications	2
2. Features	2
II. DISPLAY AND BUTTON OPERATION	3
1. Display	3
2. How to set time and calendar	3
III. BATTERY LIFE INDICATOR	5
IV. AFTER-SALE SERVICING INSTRUMENTS AND MATERIALS	5
V. CASE	6
1. How to remove the movement	6
2. How to remove the glass	6
VI. DISASSEMBLING, REASSEMBLING AND CLEANING	8
1. Liquid crystal panel side	8
2. Battery side	10
3. Cleaning	12
VII. CHECKING AND ADJUSTMENT	13
1. Guide table for checking and adjustment	13
2. Malfunction and checking points	14
3. Procedures for checking and adjustment	15
A. Check battery voltage	15
B. Check battery conductivity	15
C. Check conductivity of liquid crystal panel, circuit block and connector	16
D. Check switch components	16
E. Check circuit block and liquid crystal panel	17
F. Check current consumption	18
G. Check accuracy	18
H. Check battery life indicator	19
I. Check functioning and adjustment	19

Calibre L012A

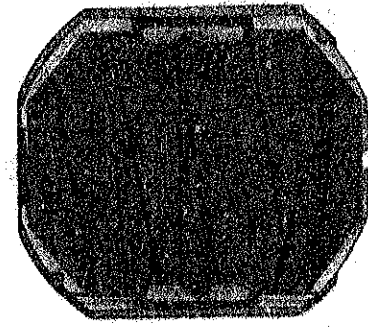

Movement

I. SPECIFICATIONS AND FEATURES

1. Specifications

Item	Calibre No. L012A
Display medium	Nematic Liquid Crystal, FEM (Field Effect Mode)
Display system	<ul style="list-style-type: none"> Time display (Usual display) Hour & Minute: 12-hour Digital Display System Calendar display (The calendar digits are displayed for 2 seconds by depressing a button "A" when the time digits are displayed.) Date and month: Automatic calendar system (Automatically adjusts for even and odd months except February of leap years.) Second display The second digits are displayed by depressing a button "A" when the calendar digits are displayed.
Additional mechanism	Battery life indicator
Crystal oscillator	32,768 Hz (Hz = Hertz—Cycles per second)
Loss/gain	Loss/gain at normal temperature range Mean monthly rate: less than 15 seconds Annual rate: less than 3 minutes
Casing diameter	φ17.5mm (15.0mm between 6 o'clock and 12 o'clock side; 17.0mm between 3 o'clock and 9 o'clock side)
Height	4.8 mm
Operational temperature range	-10°C ~ +60°C (14°F ~ 140°F)
Regulation system	Trimmer condenser
Battery power	SEIKO SB-AP silver oxide battery Battery life is approximately two years. Voltage 1.5V
IC (Integrated Circuit)	C-MOS-LSI . . . 1 unit

2. Features

SEIKO Ladies' Digital Quartz LC Cal. L012A has the same high accuracy and reliability for which the existing SEIKO Digital Quartz watches are known. It has been made even smaller and thinner for ladies' timepieces.

- (1) In addition to the "hour" and "minutes" digits, the "month and date" and "second" digits also are displayed by button operation.
- (2) It has an automatic calendar system, and therefore even and odd months except February of leap years are automatically adjusted.
- (3) Equipped with the battery life indicator, Cal. L012A lets you know the expiration of battery life in advance.
- (4) With the movement built in as a single block, it is easier to provide after-sale service.

II. DISPLAY AND BUTTON OPERATION

1. Display

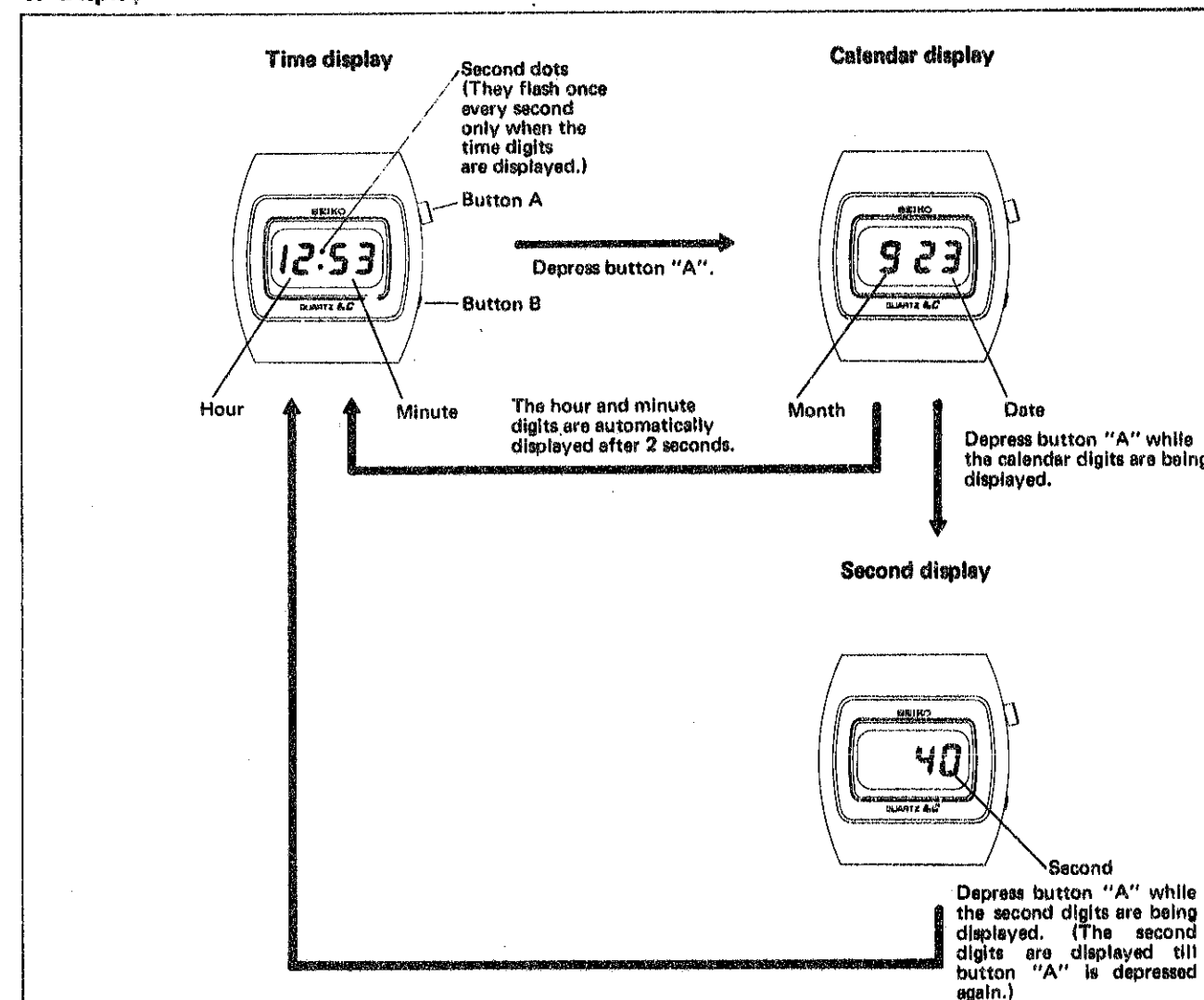

2. How to set time and calendar



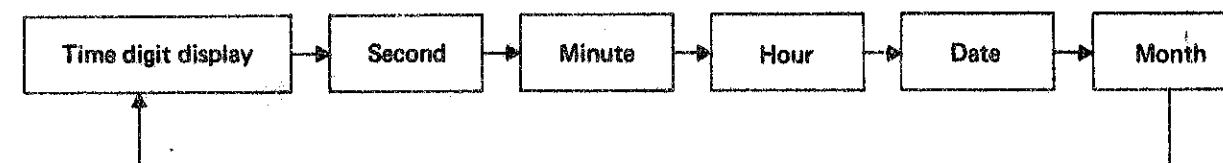



- (1) Each depression of button "B" will select the digits to be adjusted in the following order.

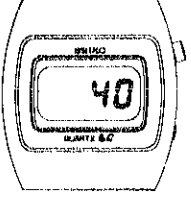

- (2) Select the digits to be adjusted, and one digit is advanced by each depression of button "A".

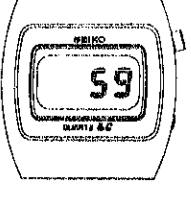
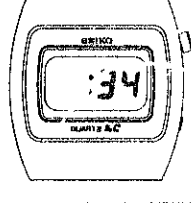
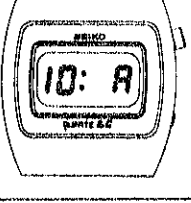
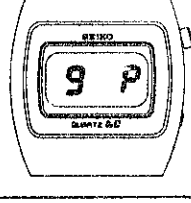
[Example]

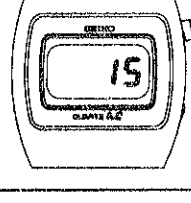
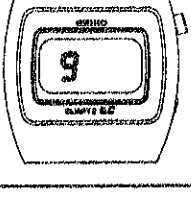
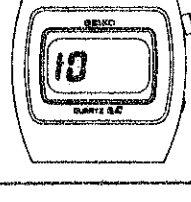
The illustration shows that the indication of 10:58:40 A.M., September 23 is changed into 09:34:00 P.M., October 15.

Digit to be adjusted	Button operation	
	SELECT (Select the digits to be adjusted.)	SET (Digit adjustment)
	Depress button "B".	Depress button "A".
Time digit display	 <p>Button A (Set) Button B (Select)</p>	
Second	 <p>Depress button "B" when the time digits are displayed. The second digits are only displayed and the other displays will be extinguished.</p>	 <p>Depress button "A" in accordance with "00" second of a time signal.*</p>
Minute	 <p>Depress button "B". The minute digits are only displayed.</p>	 <p>One digit (minute) is advanced by each depression of button "A".</p>
Hour	 <p>Depress button "B". The hour digits and "A" (stands for A.M.) or "P" (stands for P.M.) are only displayed.</p>	 <p>One digit (hour) is advanced by each depression of button "A". While setting the hour, be sure to check if it is set in the A.M. (A) or P.M. (P).</p>
Date	 <p>Depress button "B". The date digits are only displayed.</p>	 <p>One digit (date) is advanced by each depression of button "A".</p>
Month	 <p>Depress button "B". The month digits are only displayed.</p>	 <p>One digit (month) is advanced by each depression of button "A".</p>
Adjustment is completed	 <p>After the entire adjustment is completed, depress button "B". The time digits are displayed.</p>	

* The seconds are then reset to "00" and start immediately. (When the seconds count any numbers from "00" to "29", the seconds are reset to "00" automatically whenever button "A" is depressed. When the seconds count any numbers from "30" to "59" and button "A" is depressed, one minute is added and the seconds immediately return to "00".)

III. BATTERY LIFE INDICATOR

- The battery life indicator starts the entire display flashing every second when the battery life is coming to its end. However, the watch will remain accurate while the entire display is flashing.
- Note for handling the battery
Be sure to place the battery with its (-) surface up whenever it is disassembled.



IV. AFTER-SALE SERVICING INSTRUMENTS AND MATERIALS

For after-sale servicing of SEIKO Ladies' Digital Quartz LC Cal. L012A, the following instruments and materials are necessary.

1. Quartz Tester
Used to check time accuracy.

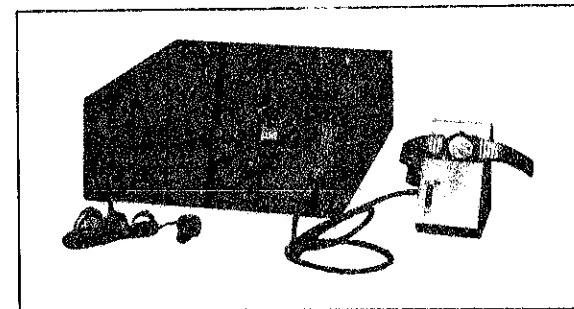

4. Static electricity protector (S-830)
Used to protect the circuit block of the Digital Quartz from being damaged by static electricity.

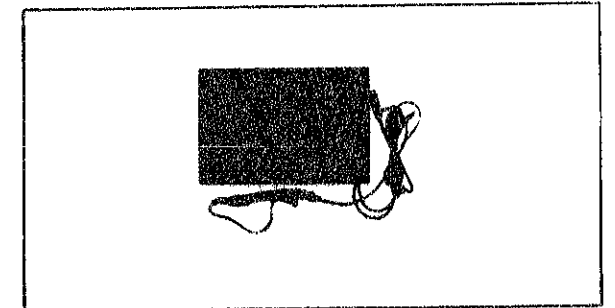

2. Micro Test
Used to check the current consumption and supplies a constant flow of voltage power.

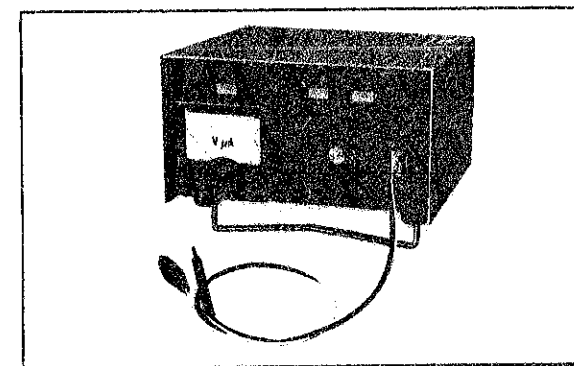

5. Plastic inserting disk (S-162)
Used to remove the glass from the caseband.

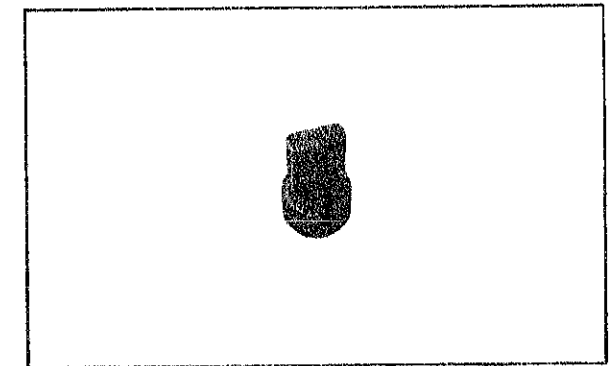

3. Volt-ohm-meter (S-831)
Used to check the battery voltage and its conductivity and to measure the current consumption.

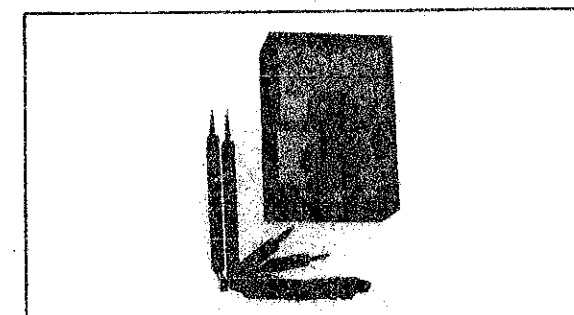

6. Plastic supporting disk (S-173)
Used to fix the glass in the caseband.

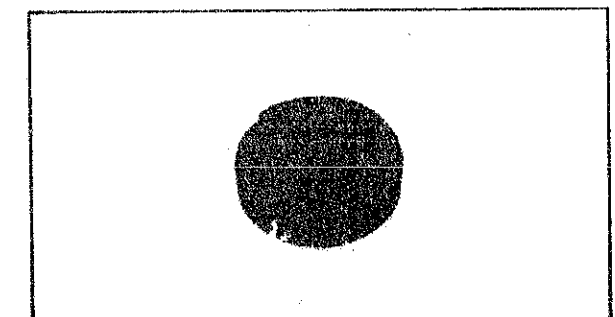

(The movement holder is not necessary for this calibre. Disassemble and reassemble the movement on the static electricity protector.)

V. CASE

1. How to remove the movement

[Example] Case No. L012-5009 (Water resistant)

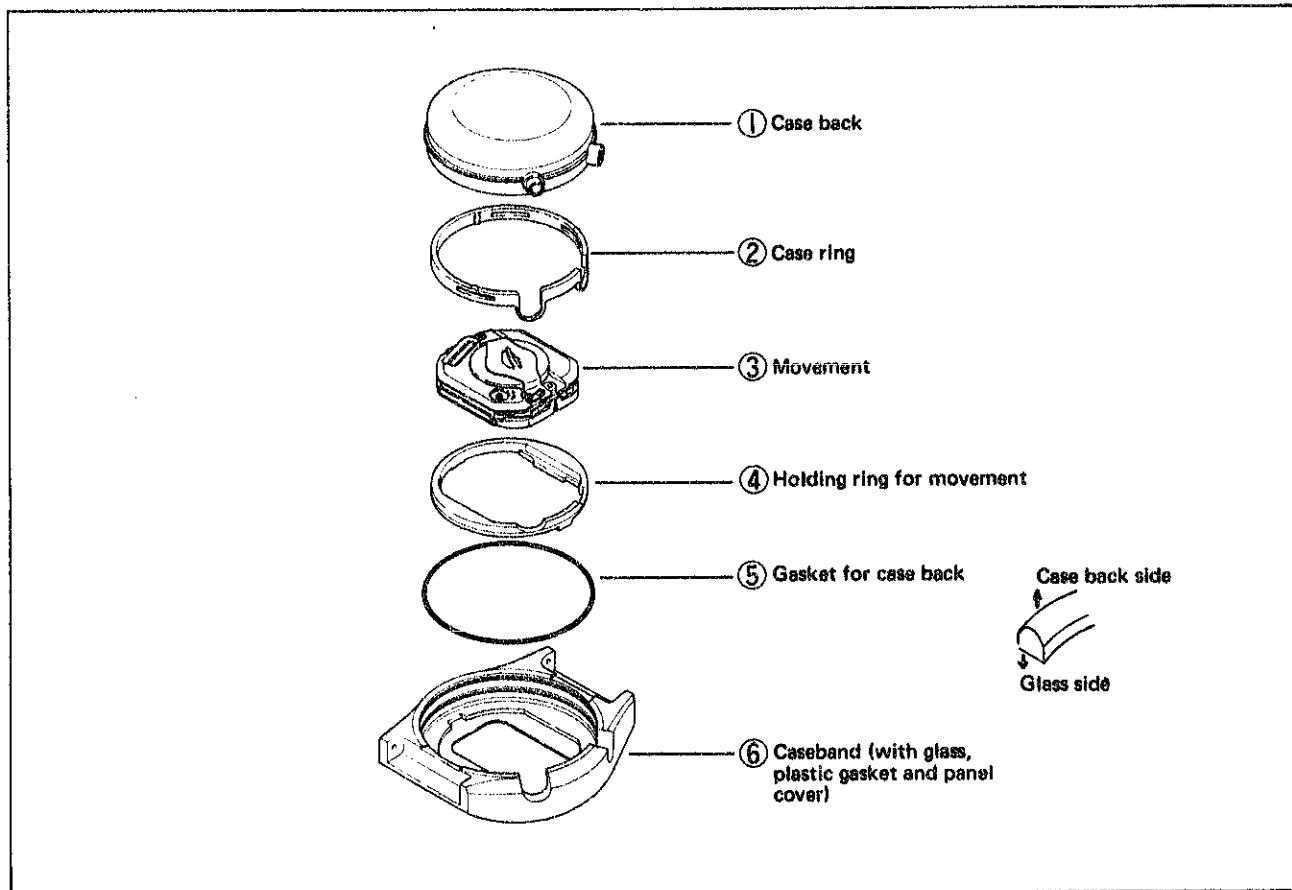

2. How to remove the glass

Do not disassemble the glass except when it is required to be replaced.

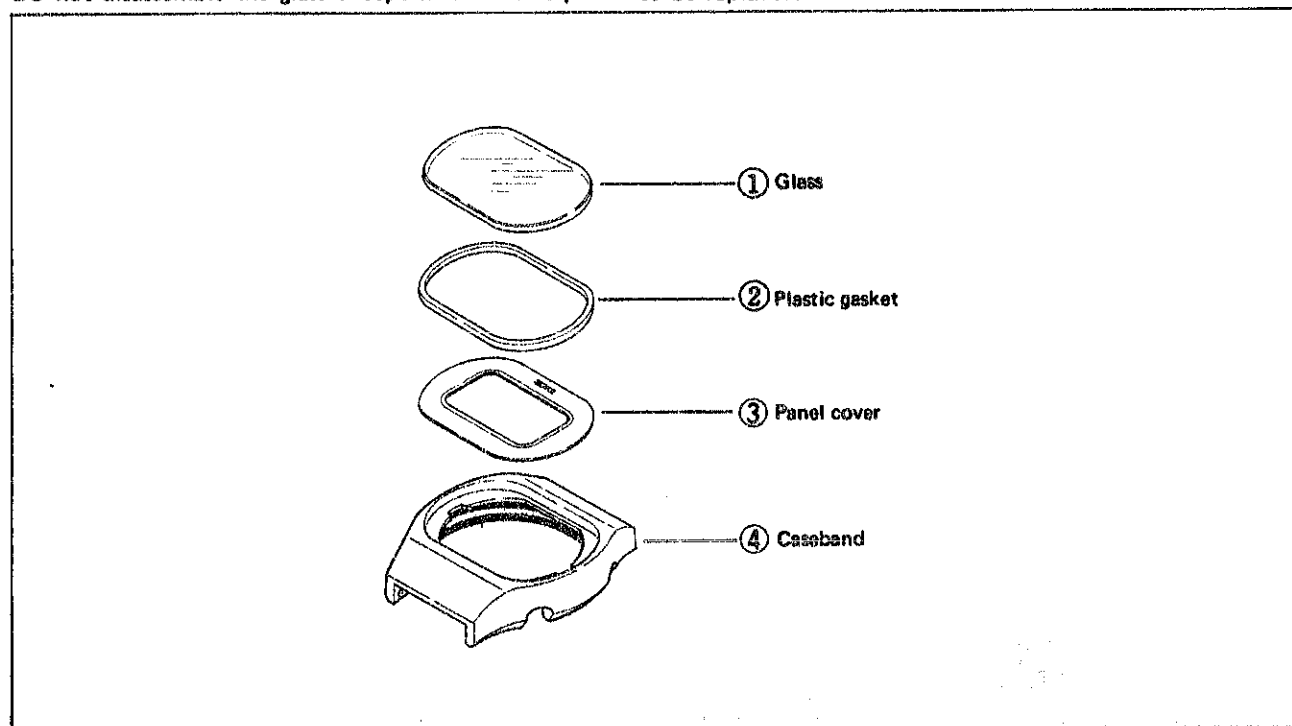

Note for disassembling and reassembling

HOW TO REASSEMBLE THE CASE BACK

Reassemble the case back with the dot and select buttons pushed out.

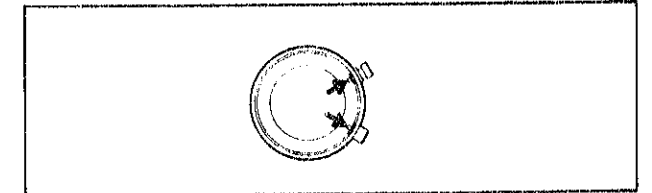

How to disassemble the buttons

- Set button
Disassemble the hook-up for set button and then pull the set button outward for disassembling.
- Select button
Push the select button inward for disassembling.

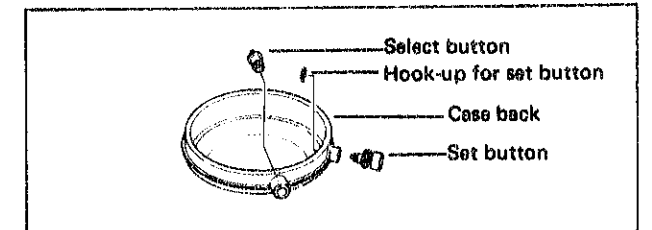

HOW TO REPLACE THE GLASS

- How to disassemble the glass
Use the inserting disk S-162. Be careful not to depress the panel cover.
(Supporting disk: Select the supporting disk whose diameter is larger than that of the glass.)

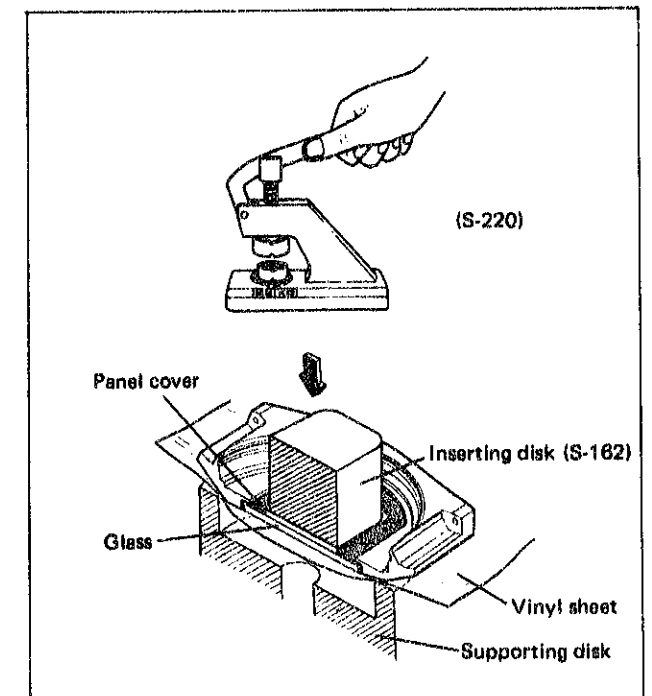

- How to reassemble the glass
Use the inserting disk S-173.
(Supporting disk: Select the supporting disk contained in S-160 Disk unit, whose diameter is smaller than the inside diameter of the caseband. $\phi 14.5 \sim \phi 16.5\text{mm}$)

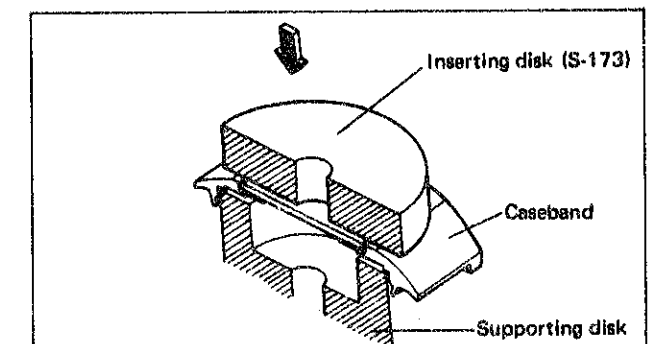

- Plastic gasket
Be sure to replace the plastic gasket with a new one when the glass is disassembled.
Be careful not to mistake the upper side for the lower side.

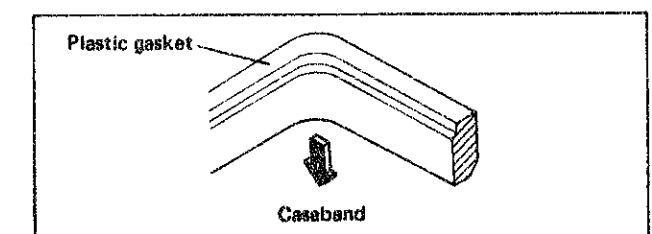

VI. DISASSEMBLING, REASSEMBLING AND CLEANING

Disassembling procedures Figs.: ① ~ ⑫

Reassembling procedures Figs.: ⑫ ~ ①

1. Liquid crystal panel side

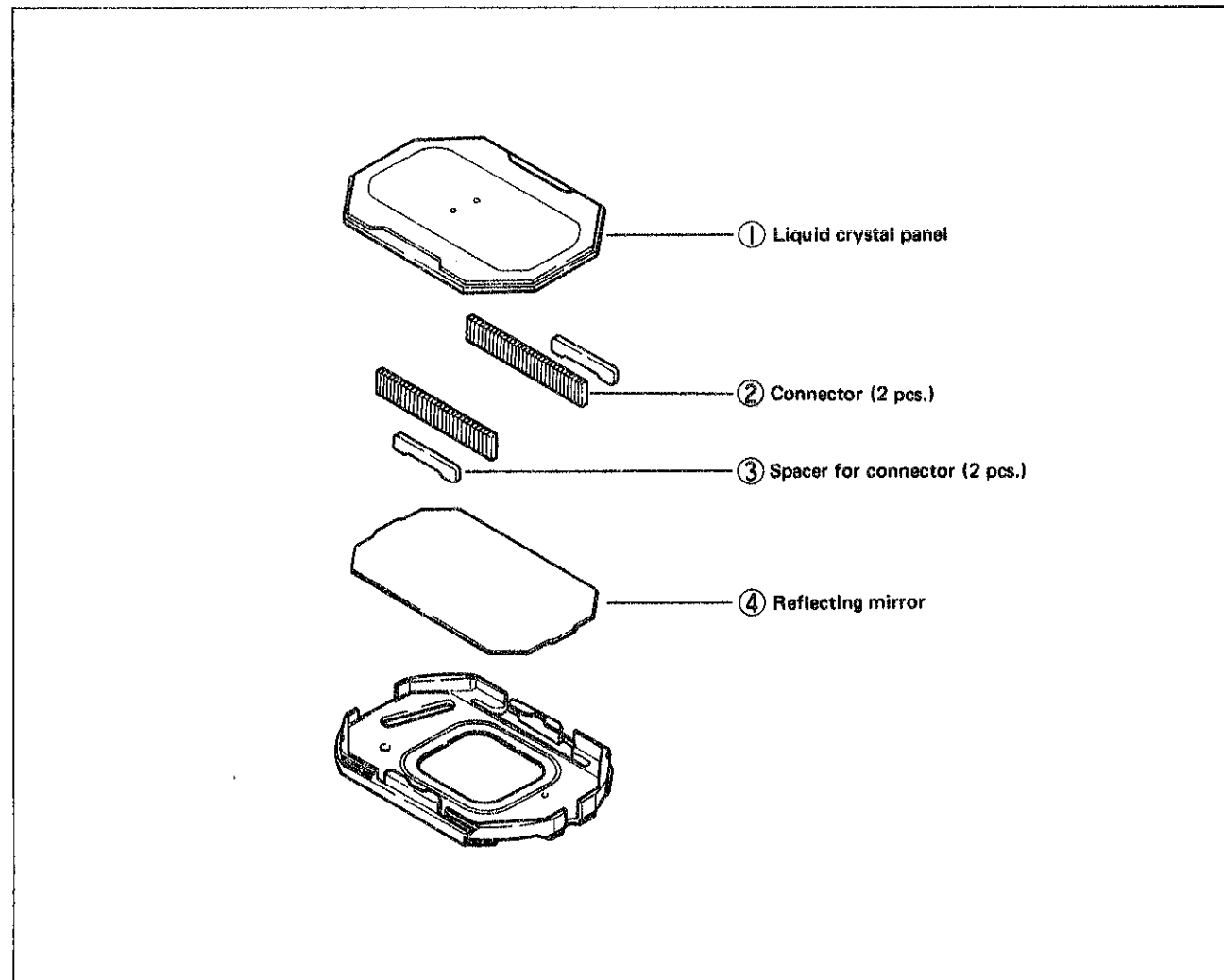

Note for disassembling and reassembling

① **How to disassemble the liquid crystal panel**
Push the liquid crystal panel frame with tweezers (marked with ⇨) outward (in the arrow ⇄ marked direction) to disassemble the liquid crystal panel. Be careful not to scratch the glass.

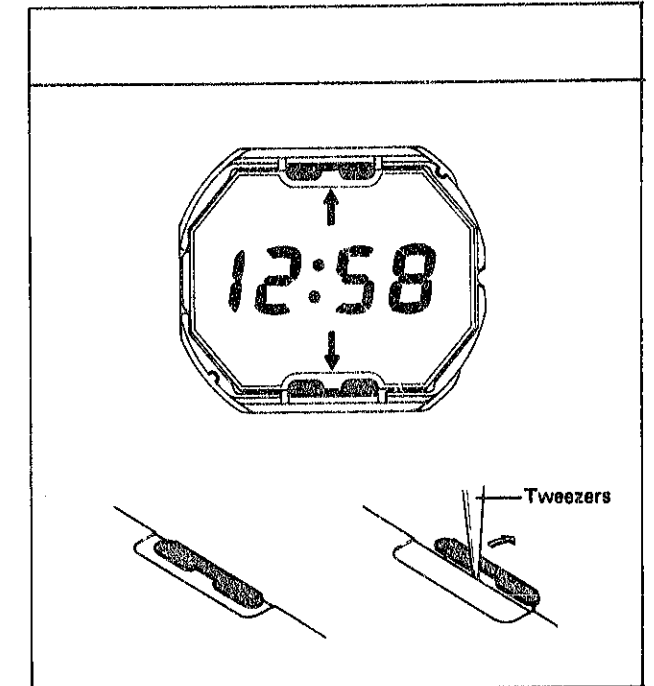

② **Connector**
Although two connectors are used, there is no difference between the two.
The black portions are conductive. Check to see if there are no scratches or contamination.

③ **Spacer for connector**
Although two spacers for connectors are used, there is no difference between the two.

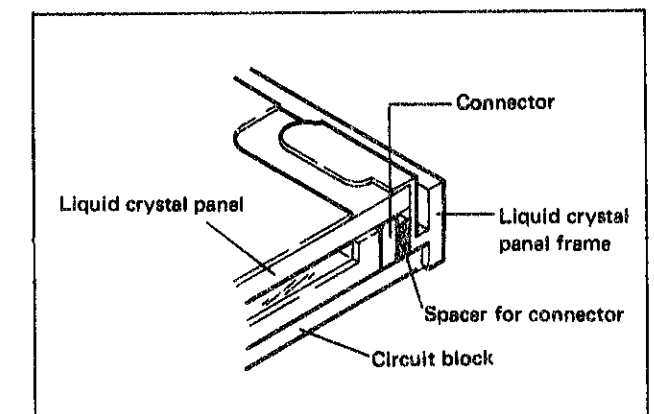

Be careful not to mistake the upper side for the lower side.

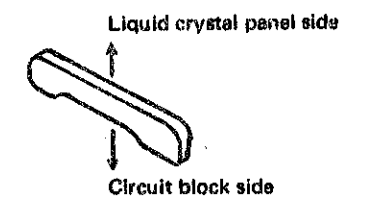

2. Battery side

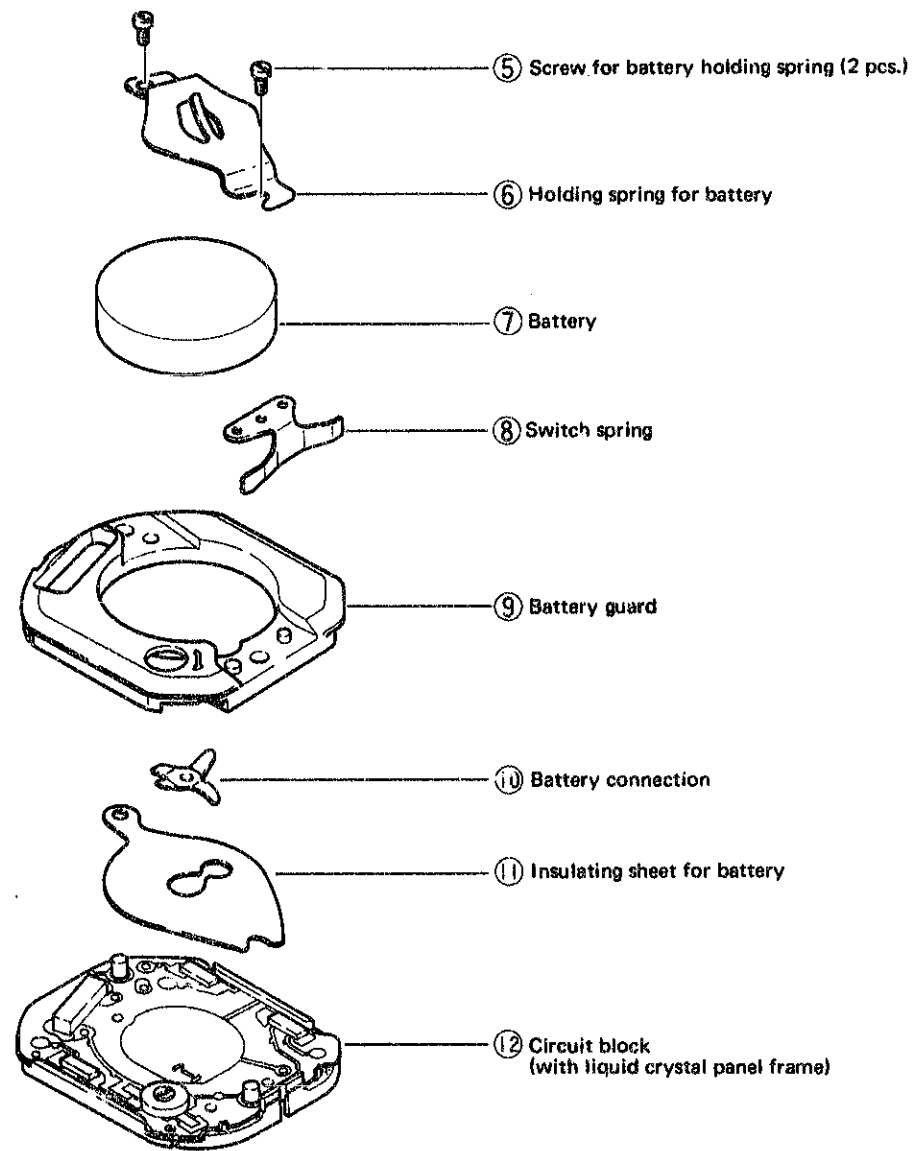

Note for Disassembling and reassembling

⑤ Holding spring for battery

How to disassemble and reassemble the battery

- Loosen the two screws two to four turns. Turn the holding spring for battery in the arrow-marked direction to disassemble the battery.
- Set the battery and the holding spring for battery in position. Tighten the screws for battery holding spring in the order of (1), (2).

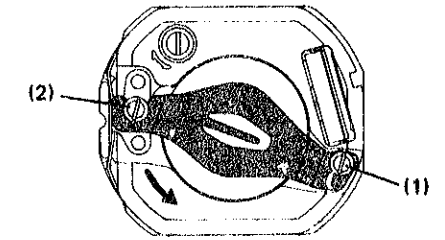

⑩ Battery connection

Handle the battery connection with the insulating sheet for battery fixed to it.

- How to reassemble the battery connection.
 1. Set the bent down portion (A) of the battery connection under the insulating sheet for battery.
 2. Set the battery connection so that the (B) portion of the insulating sheet for battery comes under the battery connection.
 3. Set the insulating sheet for battery (with the battery connection) in the movement.

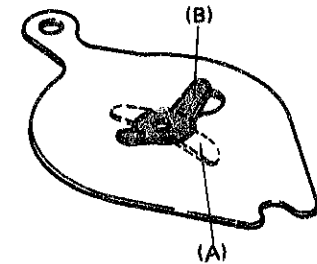

3. Cleaning

1) HOW TO CLEAN

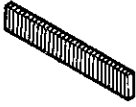
Name of parts	Cleaning	Drying	Solution	Remarks
Connector 	Rinse or wash with a soft brush.	Cool air	Alcohol	<ul style="list-style-type: none"> Do not use benzine or trichloroethylene as they expand the connector. Be sure to reassemble after drying thoroughly.
Plastic parts (Battery guard, Insulating sheet for battery, Spacer for connector)	Rinse or wash with a soft brush.	Cool air	Benzine or alcohol	
Other parts (Holding ring for battery, Battery connection, Switch spring)	Rinse or wash with a soft brush.	Cool or hot air	Benzine, trichloroethylene, or alcohol	

2) PARTS THAT MUST NOT BE CLEANED

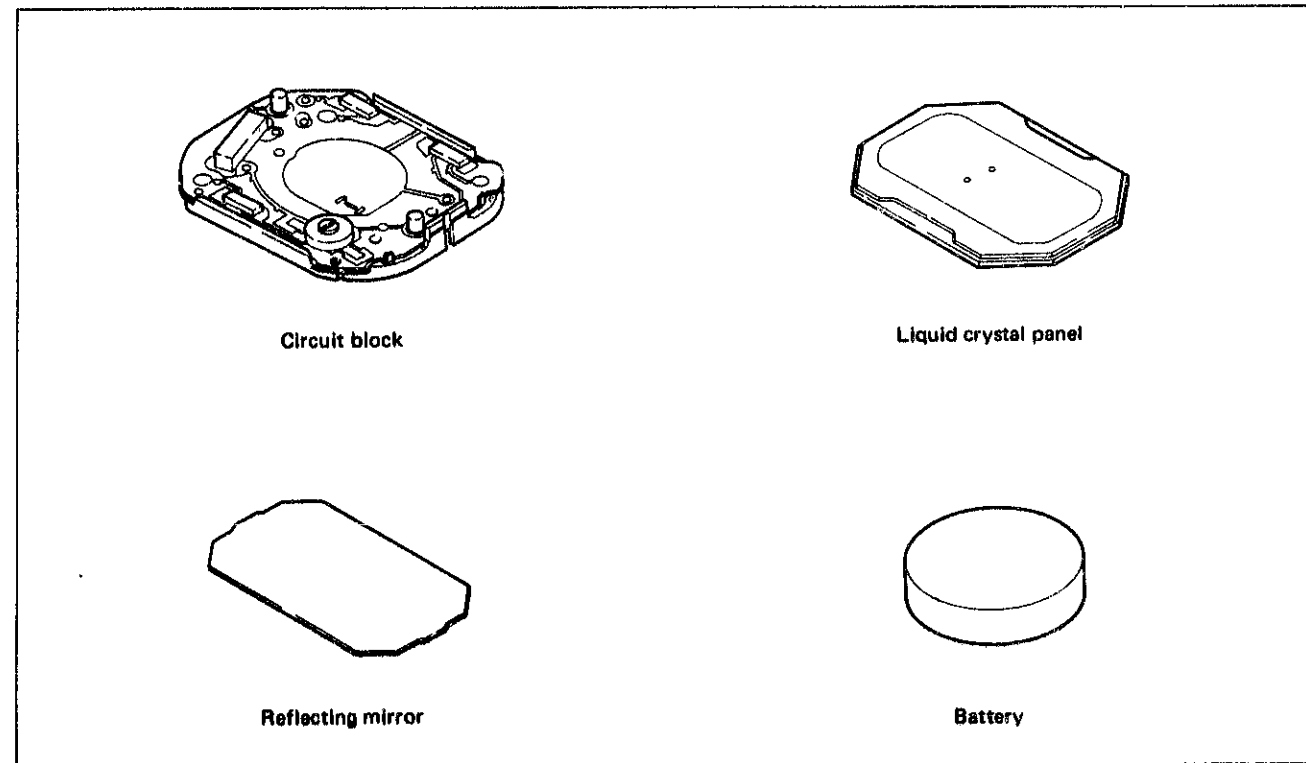

- Be sure to clean only stains on the conductive portions with a cloth moistened with benzine or alcohol and dry them with cool air. (Wipe stains on the battery with a dry cloth.)
- Wipe dust and lint off with a brush.

VII. CHECKING AND ADJUSTMENT

1. Guide table for checking and adjustment

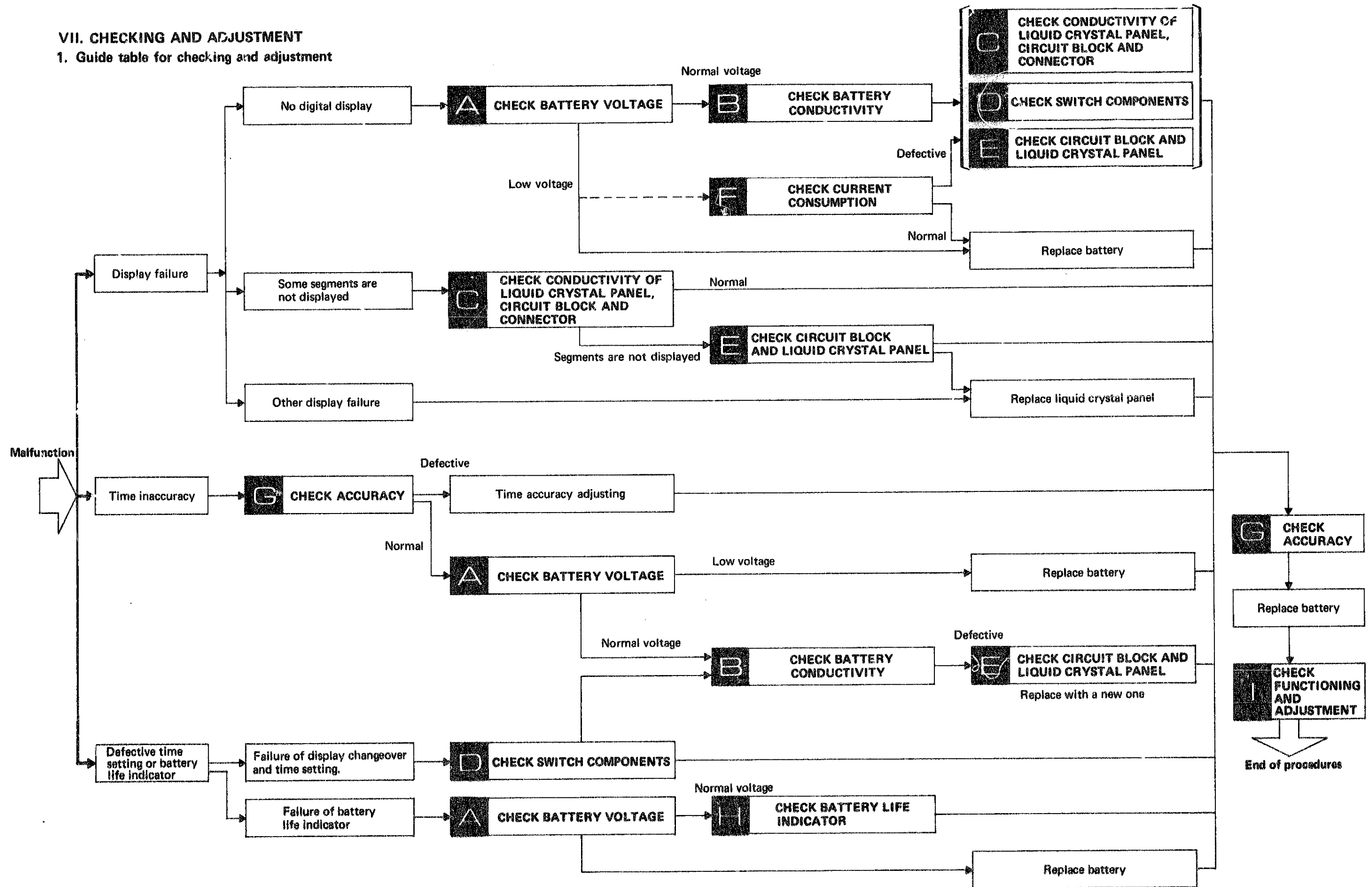

Note:

If it is difficult to locate the malfunctioning



portion, proceed to

CHECK FUNCTIONING AND ADJUSTMENT

first.

2. Malfunction and checking points

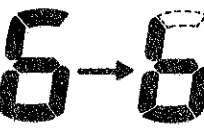
- Check in numerical order.
- Refer to "Procedures for checking and adjustment" on the following pages.

FAULTY SYMPTOMS		CHECKING POINTS							
		A	B	C		D	E	H	
		Battery voltage	Battery conductivity	Liquid crystal panel	Circuit block	Connector	Switch components	Circuit block and liquid crystal panel	Battery life indicator
DISPLAY FAILURE	Stop (Digits are displayed, but second dots do not flash.)	①	②				③	④	
	No digital display, dim digital display or extremely slow response. 	①	②	③	⑤	④		⑥	
	Some segments of the digital figures are not lighted or dim. 			②	③	①			
	All segments are lighted. 			②	③	①			
	Some portions of the liquid crystal panel will make black dots or iridescent circles.			①					
TIME INACCURACY	Gain or loss tested by Quartz Tester.	①	②						
	Though Quartz Tester indicates the normal accuracy, a watch gains or loses when it is worn on the wrist.	①	②		③			④	
DEFECTIVE TIME AND CALENDAR SETTING	Failure of time and calendar setting. Or the display extinguishes while the time and calendar are being set.						①	②	
	All digits are flashing.	①							②



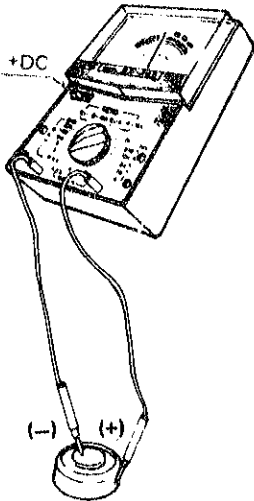
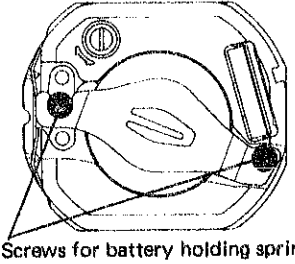

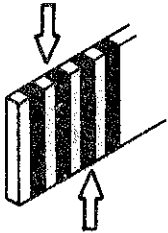
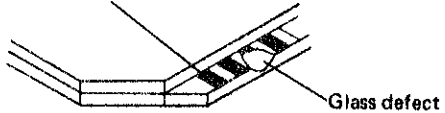
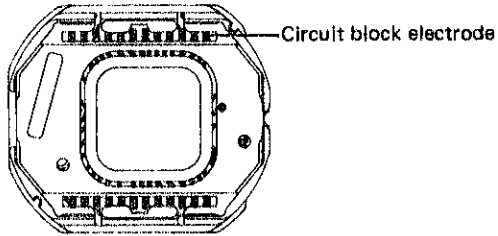

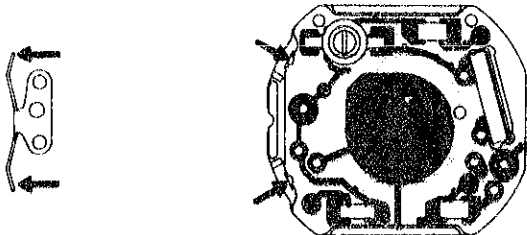
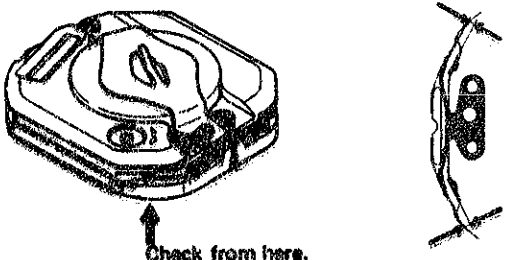
3. Procedures for checking and adjustment

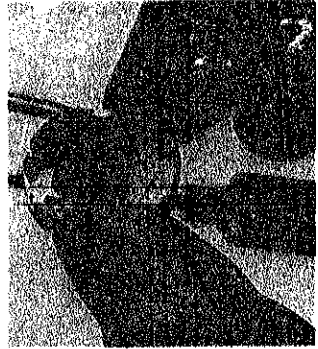
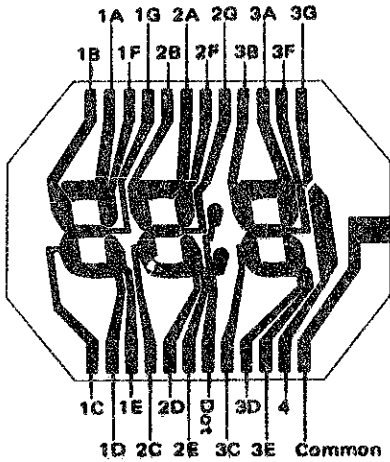
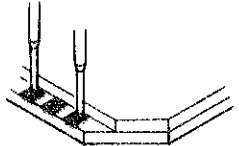
	Procedure	Result
CHECK BATTERY VOLTAGE	<p>A</p> <p>Use the following procedures to check the battery voltage.</p> <ul style="list-style-type: none"> • Set up the volt-ohm-meter Range to be used: DC 3V  <ul style="list-style-type: none"> • Measuring Probe Red (+) Battery surface (+) Probe Black (-) Battery surface (-) 	<p>More than 1.5 V → Normal Less than 1.5 V → Defective Replace the battery with a new one.</p>
CHECK BATTERY CONDUCTIVITY	<p>B</p> <p>First check Check for any contamination on the battery, battery connection and holding spring for battery.</p> <p>Second check Make sure that the screws for battery holding spring are tightened firmly.</p>  <p>Third check Check to see if there is battery electrolyte leakage.</p> <ul style="list-style-type: none"> • When there is battery electrolyte leakage, follow the procedures below. <ol style="list-style-type: none"> 1. Remove the movement from the case. 2. Disassemble the movement. 3. Clean the parts contaminated with battery electrolyte. • Clean the circuit block. <ol style="list-style-type: none"> (1) Wipe off battery electrolyte with a cloth moistened with distilled water. (If distilled water is not available, use normal tap water.) Then wipe it off with a cloth moistened with alcohol. <p>Notes:</p> <ul style="list-style-type: none"> • Do not use a cloth which gives off lint such as gauze, flannel, etc. • Do not expose the trimmer condenser to water or alcohol. <ol style="list-style-type: none"> (2) Dry with cool air by using a dryer. <ul style="list-style-type: none"> • Clean the other parts. <ol style="list-style-type: none"> 1. Wipe off battery electrolyte on the other parts with a soft brush moistened with distilled water. (If distilled water is not available, use normal tap water.) Then rinse them with alcohol. 2. Dry with cool air by using a dryer. 4. Reassemble the movement. Replace the battery with a new one. 5. Check to see if the time setting functions and the current consumption are normal. 	<p>Uncontaminated → Normal Contaminated → Defective Wipe off any foreign matter.</p> <p>No loosened screw → Normal Loosened screw → Defective Retighten screws.</p> <p>No battery electrolyte leakage → Normal Battery electrolyte leakage → Defective Wipe off battery electrolyte by following the repairing procedures on the left.</p>

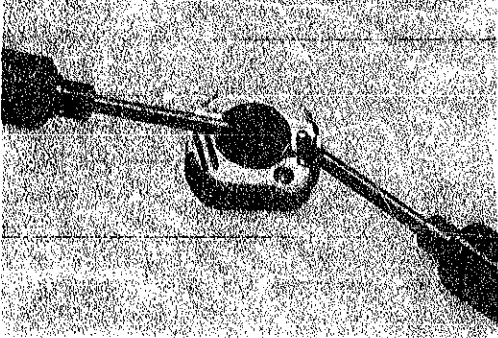
	Procedure	Result
C	<p>First check Check for any contamination, scratch and break of the connector. Be sure to check carefully the connecting portions with the liquid crystal panel and the circuit block.</p>  <p>Second check Check for any contamination and glass defect of the liquid crystal panel electrode (the connecting portion with the connector).</p> <p>Liquid crystal panel electrode</p>  <p>Third check Check for any contamination on the circuit block electrode (the connecting portion with the connector).</p> 	<p>No contamination, scratch or break → Normal Contaminated → Defective Wipe off any foreign matter. Scratch → Defective Break → Defective Replace the connector with a new one.</p> <p>No contamination or glass defect → Normal Contaminated → Defective Wipe off any foreign matter. Glass defect → Replace the liquid crystal panel with a new one.</p> <p>Uncontaminated → Normal Contaminated → Defective Wipe off any foreign matter.</p>

D	<p>First check Check for any contamination on the switch spring and the circuit block (the connecting portion with the switch spring).</p>  <p>Second check Check for clearance between the switch spring and the circuit block. (Check with the battery guard and the switch spring reassembled.)</p>  <p>Check from here.</p>	<p>Uncontaminated → Normal Contaminated → Defective Wipe off any foreign matter.</p> <p>Clearance → Normal No clearance → Defective Correct the switch spring with tweezers so that there is clearance.</p>
---	---	---

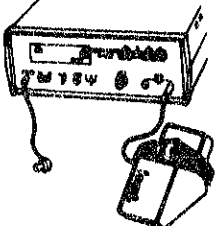
	Procedure	Result
E	<p>First check Check to see if the electric signal flows from the circuit block to the liquid crystal panel correctly.</p>  <ol style="list-style-type: none"> Set the battery in the movement and operate the watch. Disassemble the liquid crystal panel by following the disassembling procedures. Set up the volt-ohm-meter Range to be used: DC 3V Measuring Probe Red (+) Holding spring for battery Probe Black (-) Black portions of the connector (Apply the probe to several portions.) Note: Be sure to touch the connector lightly with the probe. <p>Second check Check for any broken panel pattern, short circuit, etc. of the liquid crystal panel.</p> <ol style="list-style-type: none"> Set up the volt-ohm-meter (Any range will do if more than 3V is applied to the terminal of the volt-ohm-meter.) Range to be used: OHMS R X 1 Disassemble the liquid crystal panel from the movement and place it upside down. Measuring Apply one of the two probes to the common electrode of the liquid crystal panel (Either red or black probe can be applied.) and the other probe to the segment electrode.  	<p>More than 0.8 V → Normal Less than 0.8 V → Defective Replace the circuit block with a new one. (The above voltage is obtained when measured by either the volt-ohm-meter S-831 mentioned in the Technical Guide or a volt-ohm-meter whose internal resistance is higher than that of the S-831.)</p> <p>Lights up → Normal Does not light up → Defective Replace the liquid crystal panel with a new one.</p>

	Procedure	Result
CHECK CURRENT CONSUMPTION	<p>Check to see if the current consumption is normal.</p> <ol style="list-style-type: none"> 1. Set up the volt-ohm-meter. Range to be used: DC 0.03 mA or 12 μA 2. Disassemble the holding spring for battery from the movement. 3. Measuring Probe Red (+) Battery surface (+) Probe Black (-) Screw for battery holding spring (Be sure that the screw is tightened firmly. If it is loose, the measurement might be impossible because of poor conductivity.) 	<p>Less than 2.5 μA \rightarrow Normal More than 2.5 μA \rightarrow Defective Proceed to ,  and .</p>
CHECK ACCURACY	<p>Check gain and loss of time. Set up the Quartz Tester. When the Quartz Tester QT-77 is used: Set the microphone switch (Electro-magnetic and Electric-field detection Changeover-Power switch) to LC ON position.</p>  <p>• How to adjust time accuracy Time accuracy is adjusted by turning the trimmer condenser. The watch will gain or lose according to the direction in which the trimmer condenser is turned. Adjustment should therefore be made after ascertaining with the Quartz Tester whether the watch tends to gain or lose.</p>  <p>Note for handling the trimmer condenser.</p> <ol style="list-style-type: none"> 1. Avoid excessive depressing of the trimmer condenser when turning. 2. Avoid excessive turning of the trimmer condenser as it is a precision part. 	<p>If the watch tends to gain or lose, proceed to "How to adjust time accuracy".</p>

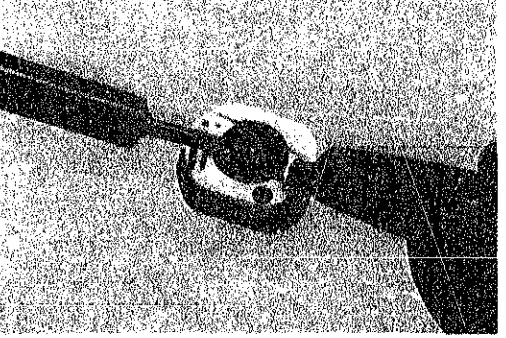
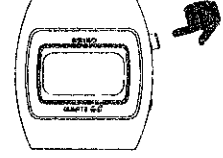
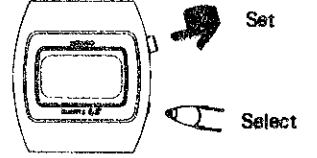
	Procedure	Result
CHECK BATTERY LIFE INDICATOR	<p>Check to see if the battery life indicator functions correctly.</p> <p>First check</p> <ol style="list-style-type: none"> 1. Set up the Micro Test Set the voltage at 1.1V. 2. Disassemble the battery from the movement and apply the terminals of the Micro Test. Red Clip (+) Screw for battery holding spring (Be sure that the screw is tightened firmly.) Battery Probe (-) Battery connection  <p>Second check</p> <ol style="list-style-type: none"> 1. Set up the Micro Test Set the voltage at 1.5V. 2. Apply the terminals of the Micro Test to the movement in the same way as in First check (2). 	<p>Display flashes \rightarrow Normal Display does not flash \rightarrow Defective Replace circuit block.</p> <p>Display does not flash \rightarrow Normal Display flashes \rightarrow Defective Replace circuit block.</p>
CHECK FUNCTIONING AND ADJUSTMENT	<p>Check to see if display changeover and adjustment function correctly by button operation.</p> <p>First check Check to see if the time display, calendar display and second display are changed over into the desired display by depressing button "A".</p>  <p>Second check Check to see if each digit is selected and set by depressing buttons "A" and "B". (Make sure that there is no dead segment.)</p> 	<p>All procedures of Disassembling and Reassembling, and Checking and Adjustment are completed.</p>