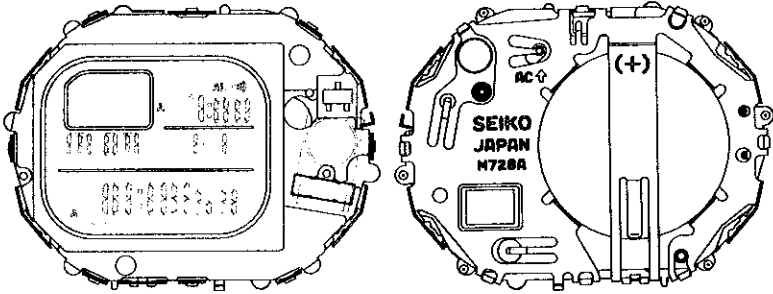

PARTS CATALOGUE / TECHNICAL GUIDE

Cal. M726A

[SPECIFICATIONS]

		Cal. No.	M726A
Item			
Module			
Module size	Outside diameter	30.0 mm between 6 o'clock and 12 o'clock sides 40.2 mm between 3 o'clock and 9 o'clock sides	
	Casing diameter	-	
	Height	6.48 mm (including the battery portion)	
Display medium		Nematic Liquid Crystal, FEM (Field Effect Mode)	
Liquid crystal driving system		1/4 multiplex driving system	
Display system		<ul style="list-style-type: none"> • Time / calendar / alarm display (12- or 24-hour indication) • Dive display • Dive table display • Log data display 	
Additional mechanism		<ul style="list-style-type: none"> • Daily alarm • Warning beep / communication beep • Illuminating light • Battery life indicator 	
Accuracy of the depth measurement		±[3% of the displayed value + 0.5 m (2 ft)]	
Loss/gain		Monthly rate at normal temperature range: less than 15 seconds	
Regulation system		Nil	
Measuring gate by quartz tester		Any gate can be used.	
Battery		SEIKO CR2025, Maxell CR2025, Matsushita CR2025 Battery life is approximately 3 years. Voltage: 3.0V	

PARTS CATALOGUE

Cal. M726A

Disassembling procedure Figs. : ① → ⑳ , ① → ②

Reassembling procedure Figs. : ② → ① , ② → ①

Lubricating: Types of oil

● Silicone oil 500,000 c.s.

Oil quantity

○ Normal quantity

◐ Extremely small

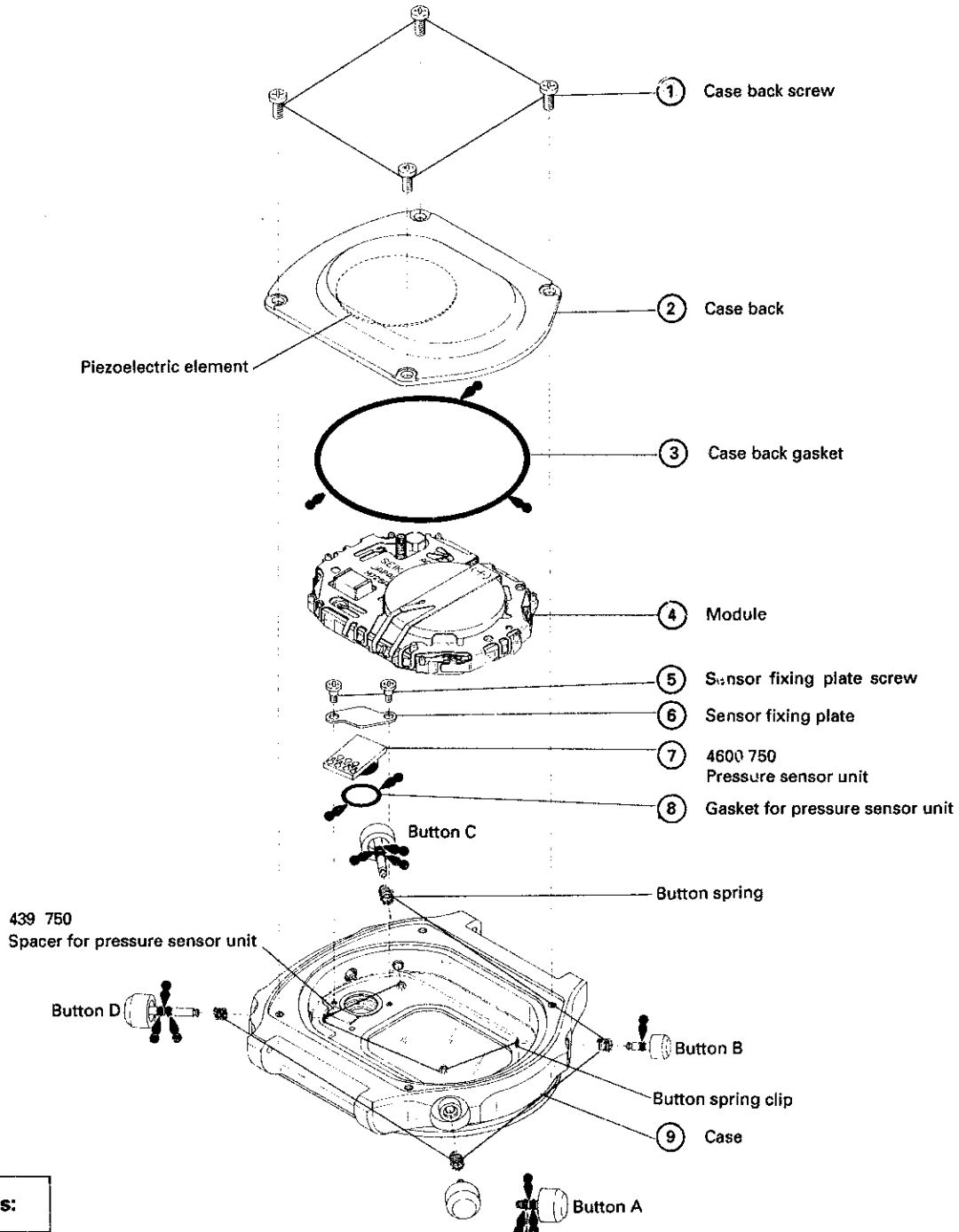

Remarks:

- When replacing the battery or repairing the watch, be sure to check the gaskets and lubricate the parts with silicone oil.
- For the parts codes which are not mentioned here, refer to "SEIKO Casing Parts Catalogue".

○ ➡ Please see the remarks on the following pages.

PARTS CATALOGUE

Cal. M726A

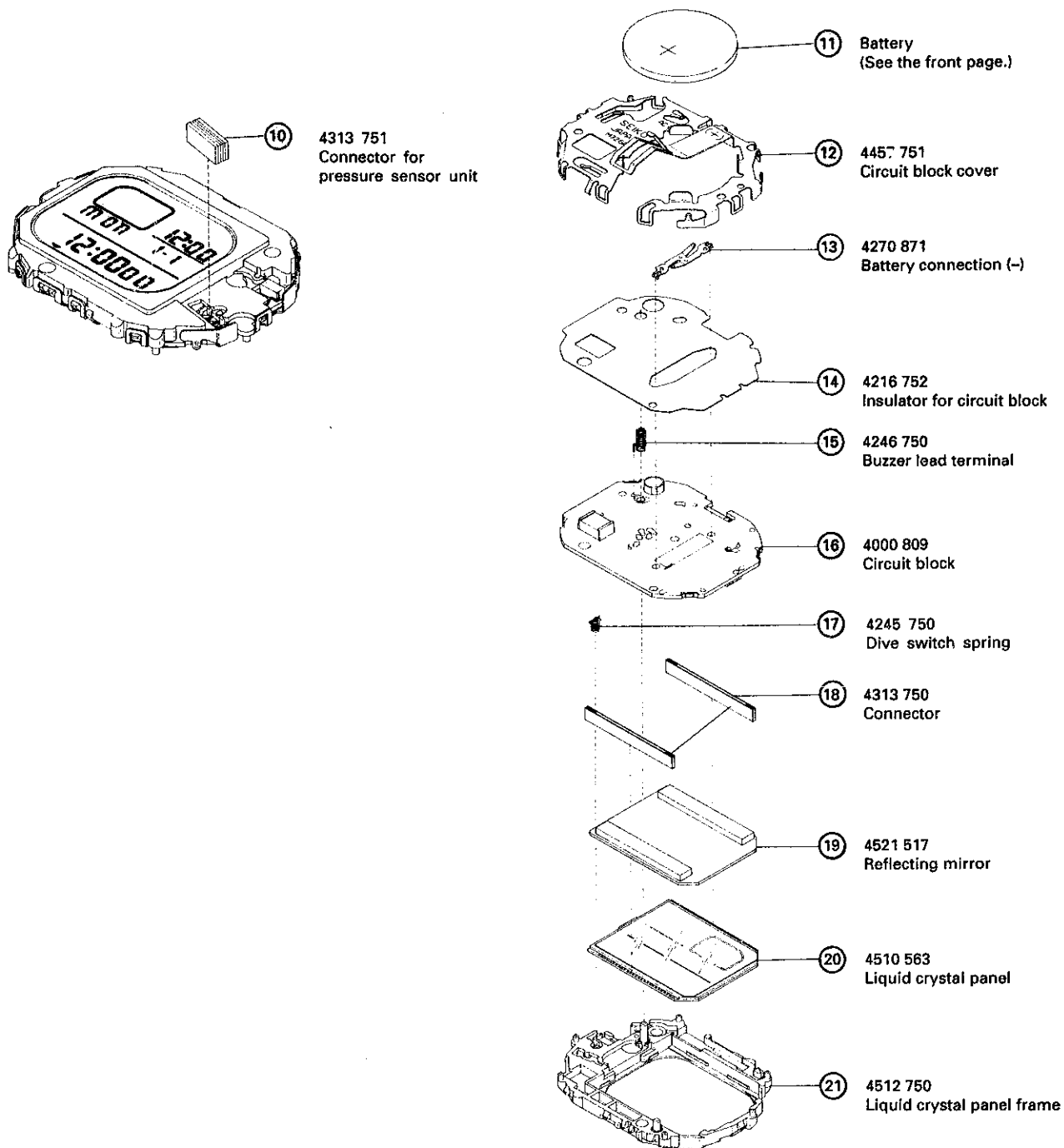

Remarks:

- ①⑨ Reflecting mirror
- ②⑩ Liquid crystal panel

The type of reflecting mirror and liquid crystal panel differ depending on models. Refer to "SEIKO Casing Parts Catalogue" to choose corresponding reflecting mirror and liquid crystal panel.

○ → Please see the remarks on the following pages.

PARTS CATALOGUE

Cal. M726A

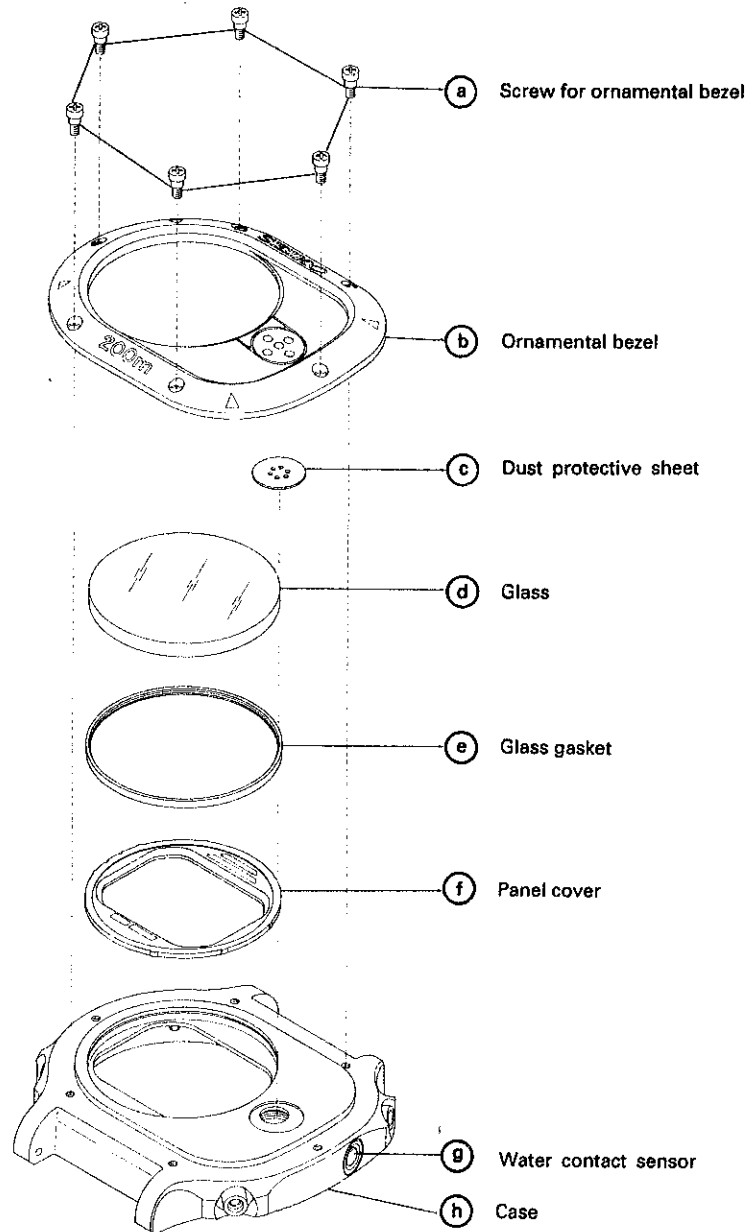

• For the codes of the above parts, refer to "SEIKO Casing Parts Catalogue".

○ ➞ Please see the remarks on the following pages.

PARTS CATALOGUE

Cal. M726A

Remarks:

⑨ Water contact sensor

Do not disassemble the water contact sensor except when it needs to be replaced. To replace it, follow the procedures below.

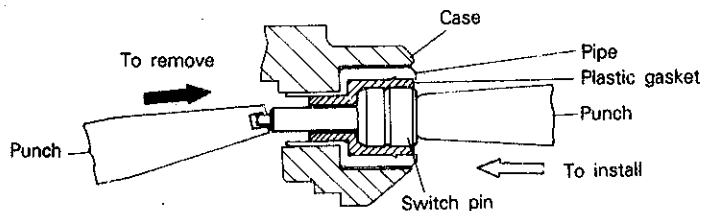

* For the codes of the above parts, refer to "SEIKO Casing Parts Catalogue".

• How to remove

Apply the punch to the water contact sensor from inside the case and hammer it to push it out.

• How to install

1) Install a new plastic gasket into the case.

2) Insert a new switch pin, apply the punch to it and hammer it to push it in.

Note: Do not use the old plastic gasket and switch pin once they are removed.

TECHNICAL GUIDE

Cal. M726A

- The explanation here is only for the particular points of Cal. M726A.
- For the repairing, checking and measuring procedures, refer to the "TECHNICAL GUIDE, GENERAL INSTRUCTIONS".

I. STRUCTURE OF THE CIRCUIT BLOCK

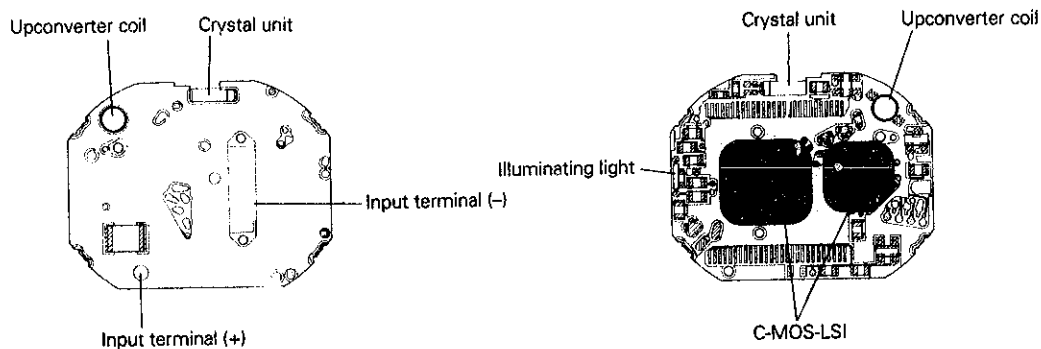

II. REMARKS ON INSTALLING THE BATTERY

- After the battery is replaced with a new one, or after the battery is re-installed following the repairing procedures, be sure to reset the circuit by pressing down the AC terminal of the circuit block cover with conductive tweezers.

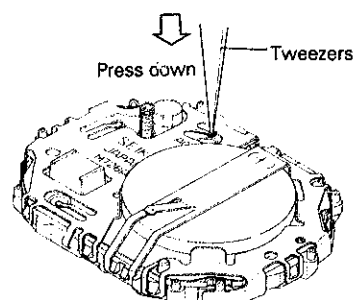

III. REMARKS ON DISASSEMBLING AND REASSEMBLING

① Case back screw

- To prevent the screws from loosening, apply the adhesive for band adjustment screw (S-312) to the case back screws.
- After checking the 20-bar water resistance, be sure to fasten the case back screws again.

④ Module

When installing the module into the case, be sure to check that the dive switch spring securely touches the water contact sensor terminal.

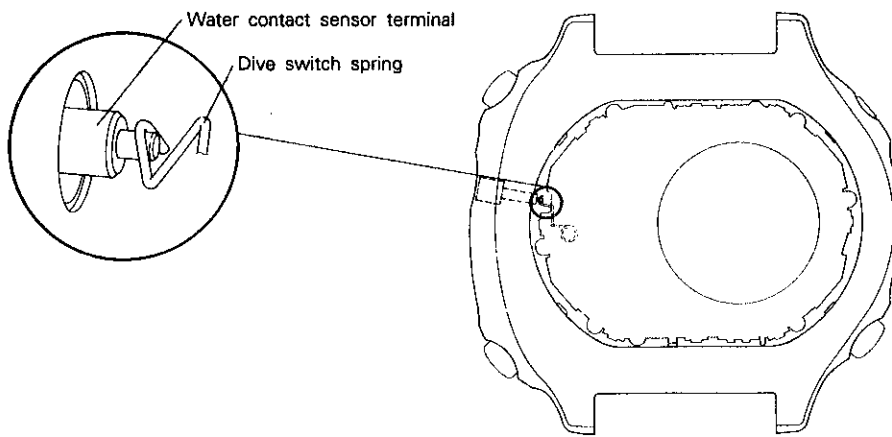

⑥ Sensor fixing plate

• How to install

Set the sensor fixing plate on the pressure sensor unit so that the plate's blue insulator faces toward the sensor. Take care not to tighten the sensor fixing plate screw forcibly.

Note: Do not wash the sensor fixing plate as the insulator will easily come off.

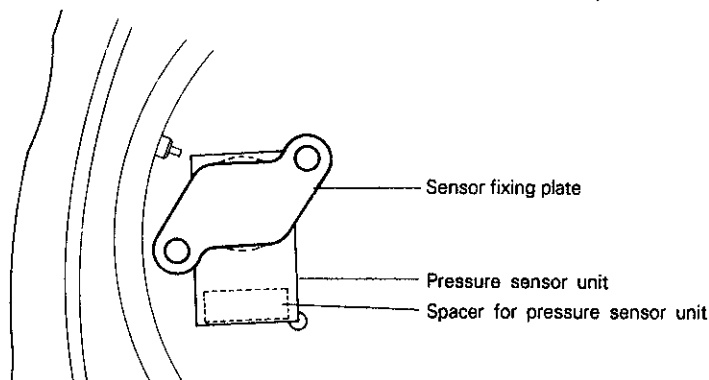

⑦ Pressure sensor unit

• How to remove

Catch the circuit board of the pressure sensor unit with tweezers as shown in the illustration and lift it up alternately at both sides.

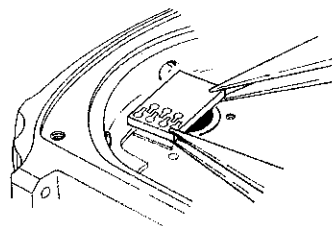

• **How to install**

- Press all around the shaded portion in the illustration gently and evenly with tweezers.
- Set the pressure sensor unit so that the corner of the circuit board is positioned at the center of the guide hole as shown in the illustration.

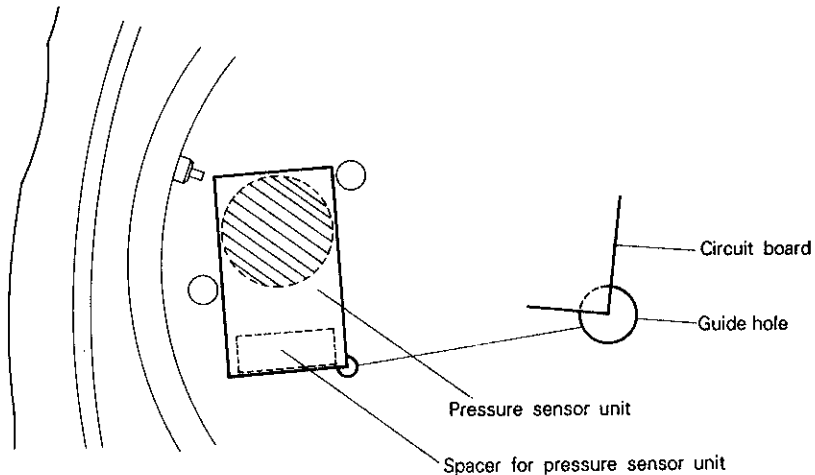

⑩ Connector for pressure sensor unit

• **How to install**

Catch the connector for pressure sensor unit with tweezers and set it to the liquid crystal panel frame as shown in the illustration.

- Notes:**
1. Unlike connectors of the conventional type, the connector's wires run parallel to the longer surfaces of the connector and break easily. Therefore, handle the connector with care when installing it.
 2. Do not press the wires with tweezers.

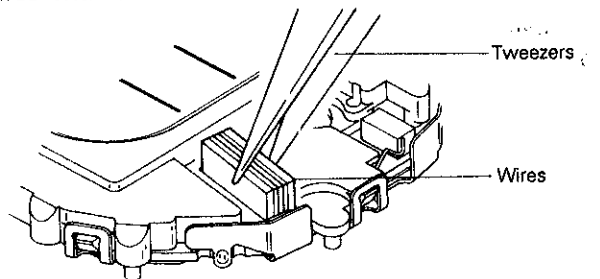

⑪ Battery

After installing the battery, be sure to reset the circuit. (Refer to "REMARKS ON INSTALLING THE BATTERY".)

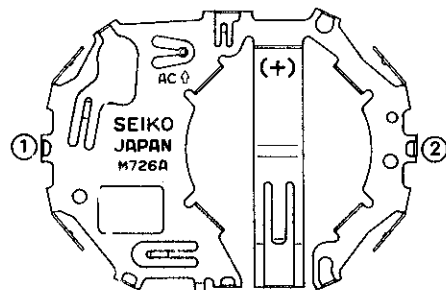

⑫ Circuit block cover

• **How to install**

- Set the hooking portions of the circuit block cover in the order of ① and ② in the illustration at right.
- Check that the hooking portions are securely set as shown in the illustration below.

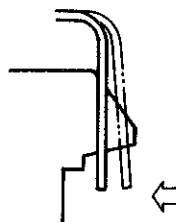

⑮ Buzzer lead terminal

Set the buzzer lead terminal as shown in the illustration.

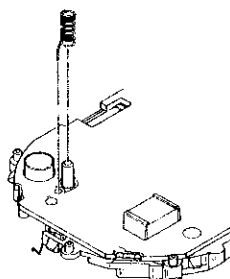

⑯ Circuit block

- When cleaning the circuit block, never use any cleaning solvent.
- When handling the circuit block alone, be sure to ground it lest it should be damaged by static electricity.

⑰ Dive switch spring

Set the dive switch spring as shown in the illustration.

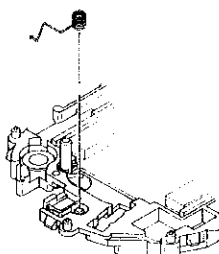

IV. VALUE CHECKING AND FUNCTION CHECKING

• Current consumption

For the whole of the module: less than 2.0 μ A
 For the circuit block alone : less than 1.5 μ A

• Upconverter coil resistance

80 Ω ~ 120 Ω

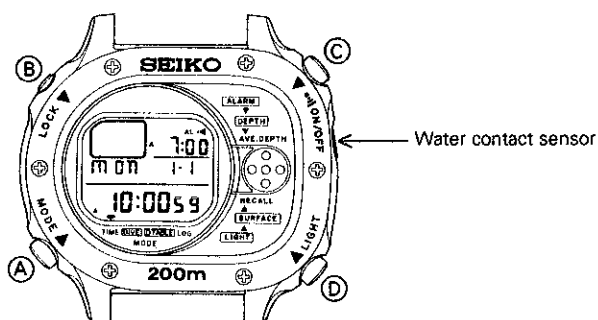

• All the segments lit up

- 1) Press Button A (MODE) to show the TIME/ALARM mode (TIME).
- 2) Press Button B (LOCK) to show the TIME/ALARM SETTING display. (The hour digits of the alarm start flashing.)
- 3) Press Buttons C and D at the same time.
- 4) Check that the display at right appears.
- 5) To return to the TIME/ALARM mode, press any one of Buttons A, C and D.

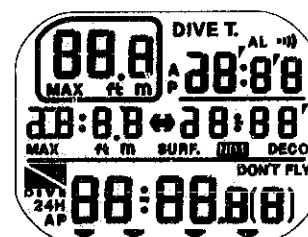

TECHNICAL GUIDE

Cal. M726A

- **Time accuracy**

To measure accuracy, light up all the segments of the display. Note that the time accuracy cannot be adjusted even if it is found defective.

- **Mode change**

Check that the mode changes as follows with each press of Button A. Also check that the corresponding mode indicators appear.

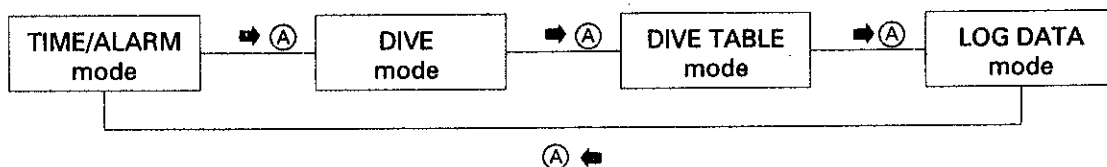

- **Changeover between TIME/ALARM mode and TIME/ALARM SETTING display**

- 1) Press Button A to show the TIME/ALARM mode.
- 2) Press Button B to check that the TIME/ALARM SETTING display appears. (The hour digits of the alarm start flashing.)
- 3) Check that the flashing digits change over as follows with each press of Button C.

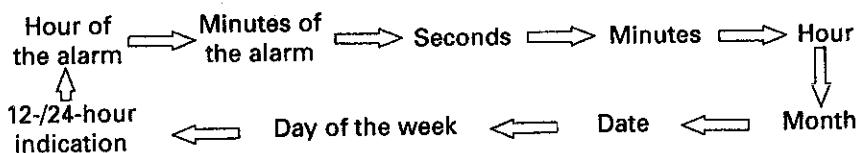

* By pressing Button D, the flashing digits can be set. Changeover between 12- and 24-hour indications can be made while "A"/"P"/"24H" mark is flashing, by pressing Button D.

- 4) To return to the TIME/ALARM mode, press Button B.

- **Alarm test**

- 1) Press Button A to show the TIME/ALARM mode.
- 2) Press Buttons C and D at the same time to check that the alarm rings.

- **Illuminating light**

- 1) Press Button A to show the TIME/ALARM or DIVE mode.
- 2) Press Button D to check that the light illuminates the display for 3 to 4 seconds.

TECHNICAL GUIDE

Cal. M726A

• Changeover of depth unit

1) Press Button A to show the DIVE mode. (The mode indicator points to **DIVE**).

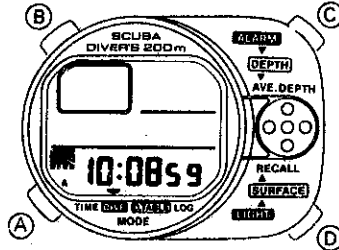

2) Check that the unit of depth changes over alternately between meters and feet, with each press of Button B for 1 to 2 seconds.

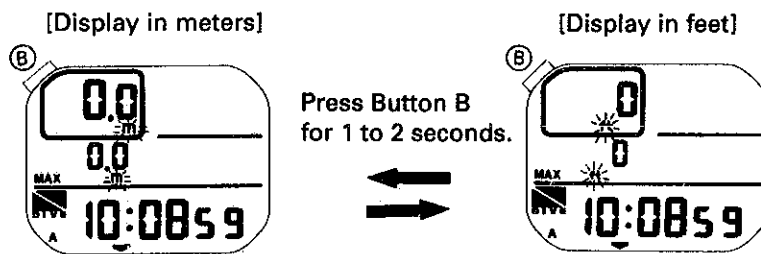

• Checking the function of water contact sensor

- 1) Press Button A to show the DIVE mode.
- 2) Moisten your finger with water and put it over the water contact sensor. While doing so, check that you touch both the sensor and case.
- 3) Check that the dive flag flashes.

Note: If the dive flag does not flash, check if the dive switch spring and the water contact sensor terminal securely contact with each other. (See page 6.)

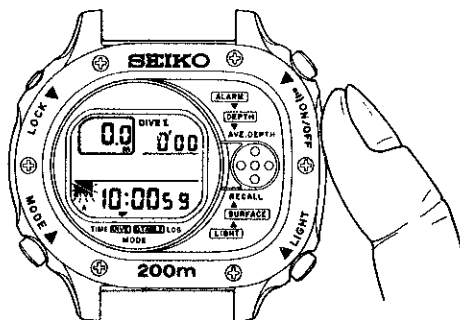

TECHNICAL GUIDE

Cal. M726A

• Depth measurement

Do not use gas or air pressure-type resistant tester such as Air Pressure Water Resistance Tester S-451 to test the depth measurement as it might damage the pressure sensor unit.

To check the accuracy of depth measurement, use the Water Resistance Tester S-461 by the following procedure:

- 1) Press Button A to show the DIVE mode.
- 2) Press Button B to check that the depth is displayed in meters. (If not, press Button B for 1 to 2 seconds to change the depth unit to "m".)
- 3) Place the watch into the water tester chamber and apply 5 atmospheric pressure/bar for 1 minute.
- 4) Release the tester pressure and take the watch out of the water tester.

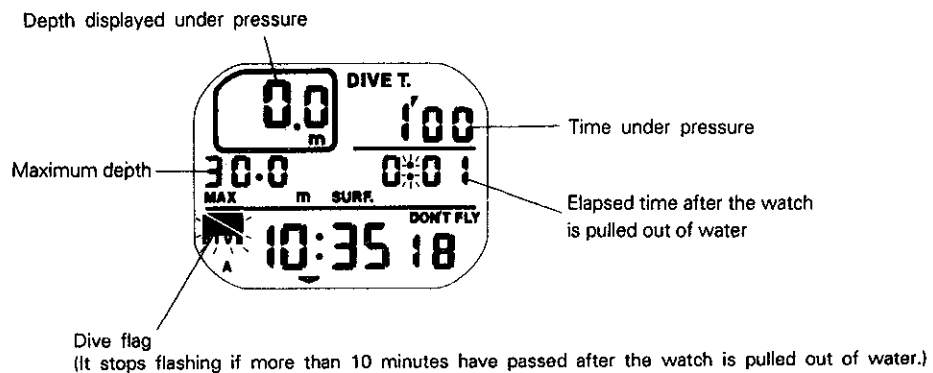

Result:

- a) If the depth falls within the range from 45.0 m to 55.0 m, the sensor unit functions properly.
- b) If the range is off the range specified above, there is a possible problem:
 - ① Pressure applied to the water resistance tester incorrectly. (In this case the watch should be retested to make sure the pressure is applied correctly.)
 - ② Sensor unit malfunction. (In this case, replace the pressure sensor unit or water contact sensor.)

After the checking procedure is completed, clear the data in memory.

- 1) More than 10 minutes after the watch is pulled out of water when the dive flag stops flashing, press Button B for 3 to 4 seconds in the DIVE mode. The maximum depth, elapsed time after the watch is pulled out of water and the time the watch is under pressure are all cleared from memory.

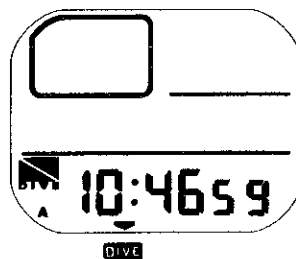

- 2) Press Button A to show the LOG DATA mode.

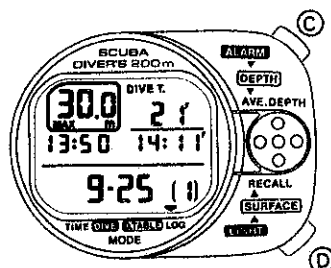

3) Press Buttons C and D at the same time for 1 to 2 seconds to clear the data in memory.

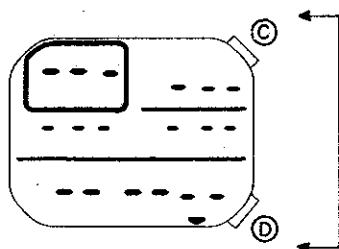

- **Note for 20-bar water resistance check**

If 20 atmospheres of pressure/bar is applied to the watch, "---" is displayed for the maximum depth. Clear the memory following the procedures described above.