

PARTS CATALOGUE / TECHNICAL GUIDE

Cal. M795A

Cal. M796A

CAUTION

The SEIKO SCUBA Cal. M795A and M796A are intended for use in diving, an inherently hazardous form of recreation. Therefore, it is absolutely essential that you strictly observe all instructions for the repairing and checking of the SEIKO SCUBA watches described in this guide.

Take the greatest possible care when repairing and checking the depth measurement function as well as the water resistant quality of these watches, because the depth measurement serves as a guideline when the user is making a dive.

In addition, you must fully understand the following:

- These watches are for use in recreational scuba diving (no-decompression diving), and are not for decompression diving, saturation diving or diving at altitudes.
- They are for use in water having a temperature range of 0° C to 40° C.
- They can measure the depth of sea water correctly, whose specific gravity is 1.025, but not that of fresh water.

It is recommended that you explain to users the specifications of the watch, limits of use and cautions on improper use as required. In doing so, refer to the "CAUTION" included at the beginning of the instruction booklet of the watch.

[SPECIFICATIONS]

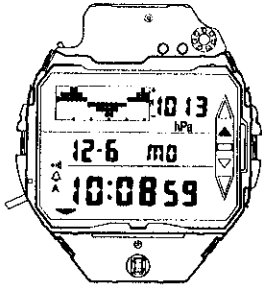
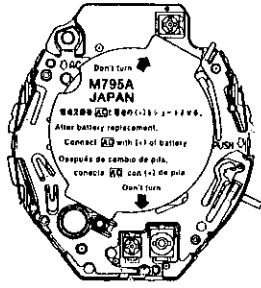
Item		Cal. No.	M795A	M796A	
Module					
			Illustrated: Cal. M795A.	(x 1.0)	
Module size	Outside diameter	ø31.8 mm 36.3 mm between 6 o'clock and 12 o'clock sides 31.67 mm between 3 o'clock and 9 o'clock sides			
	Casing diameter	ø31.8 mm 36.3 mm between 6 o'clock and 12 o'clock sides 31.67 mm between 3 o'clock and 9 o'clock sides			
	Height	6.55 mm (including the battery portion)			
Display medium		Nematic Liquid Crystal, FEM (Field Effect Mode)			
Liquid crystal driving system		1/5 multiplex driving system			
Display system		<ul style="list-style-type: none"> • Time/atmospheric pressure display • Depth/water temperature (ft / ° F) display (Cal. M795A) • Depth/water temperature (m / ° C) display (Cal. M796A) • Maximum depth/dive data memory display • Stopwatch display • Regular alarm display 			
Additional mechanism		<ul style="list-style-type: none"> • Atmospheric pressure change indicator • Atmospheric pressure graph • Barometer adjustment function • Recording of dive data • Depth measurement • Depth change indicator • Depth graph • Depth warning function • Illuminating light • All segments light-up system • Battery life indicator 			
Measurable range of depth		0 ~ 130 ft	0 ~ 40 m		
Measurable range of atmospheric pressure		600 hPa ~ 1050 hPa			
Measurable range of temperature		15° F ~ 120° F	-10° C ~ +50° C		
Accuracy of sensors		At a stable temperature	Influence of temperature change of 18° F	At a stable temperature	Influence of temperature change of 10° C
	Depth	±(displayed value x 5 % + 2 ft)	±1 ft at a depth between 0 ~ 33 ft	±(displayed value x 5 % + 0.6 m)	±0.3 m at a depth between 0 ~ 10 m
			±2 ft at a depth between 33 ~ 130 ft		±0.6 m at a depth between 10 ~ 40 m
Atmospheric pressure	±(pressure change x 5 % + 5 hPa)	±16 hPa	±(pressure change x 5 % + 5 hPa)	±16 hPa	

Item		Cal. No.	M795A	M796A
Accuracy of sensors	Water temperature		±4° F within a temperature range of 32 ~ 104° F	±2.0° C within a temperature range of 0 ~ 40° C
			±6° F within a temperature range of 104 ~ 120° F	±3.0° C within a temperature range of 40 ~ 50° C
			+4° / -8° F within a temperature range of 15 ~ 32° F	+2.0° / -4.0° C within a temperature range of -10 ~ 0° C
Loss/gain			Monthly rate at normal temperature range: less than 15 seconds	
Regulation system			Nil	
Measuring gate by quartz tester			Use 10-second gate with all segments lighting up.	
Battery			SEIKO CR2025, Sony CR2025, Matsushita CR2025 Battery life is approximately 3 years. Voltage: 3.0 V	

PARTS CATALOGUE

Cal. M795A, M796A

Disassembling procedure Figs. : ① → ⑳

Reassembling procedure Figs. : ㉓ → ①

Lubricating: Types of oil

○ SEIKO Watch Oil S-6

○ Silicone oil 500,000 c.s.

Oil quantity

○ Normal quantity

○ Extremely small

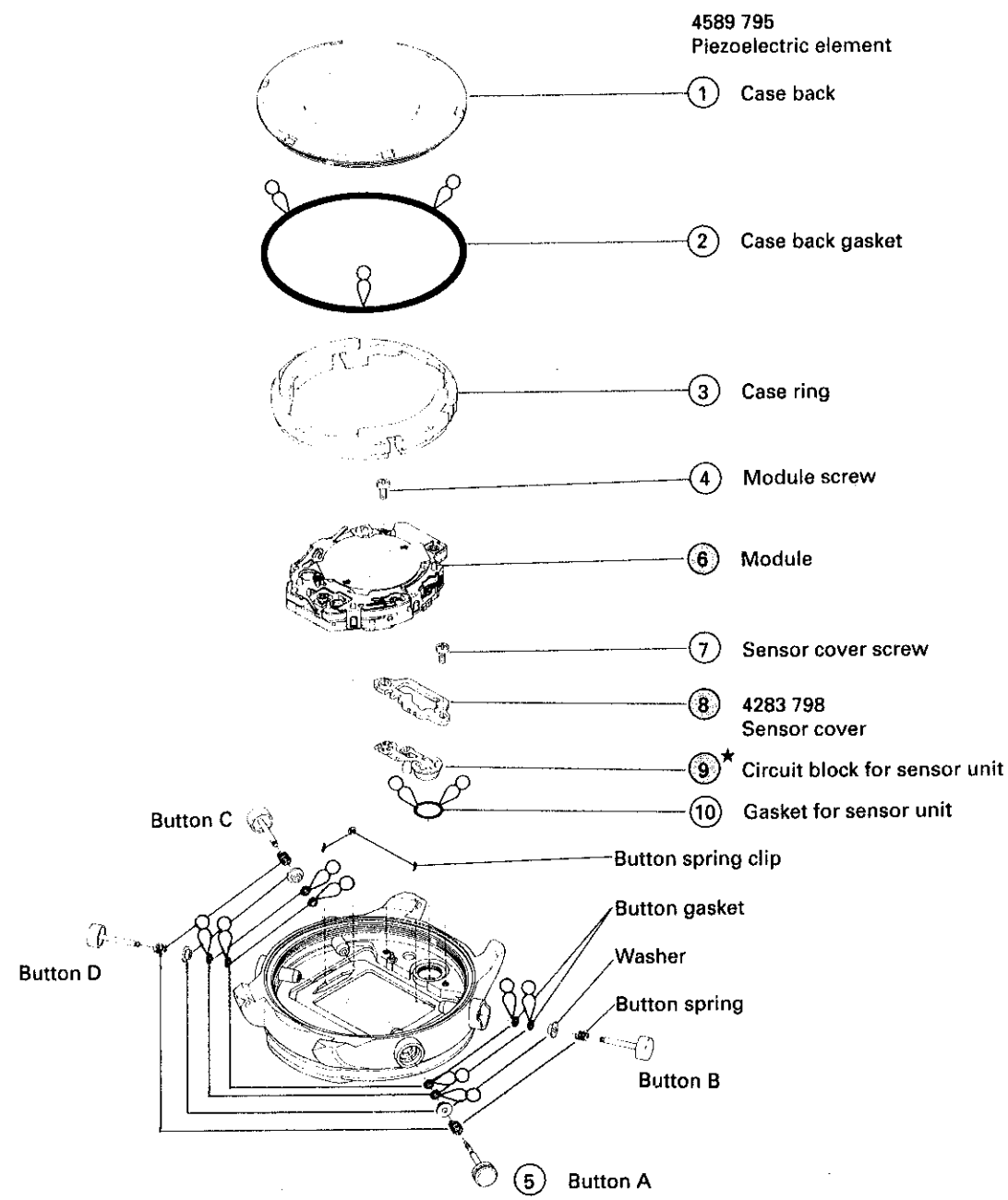

* Do not disassemble any parts not preceded by a circled number except when they need to be replaced.

○ → Please see the remarks on the following pages.

PARTS CATALOGUE

Cal. M795A, M796A

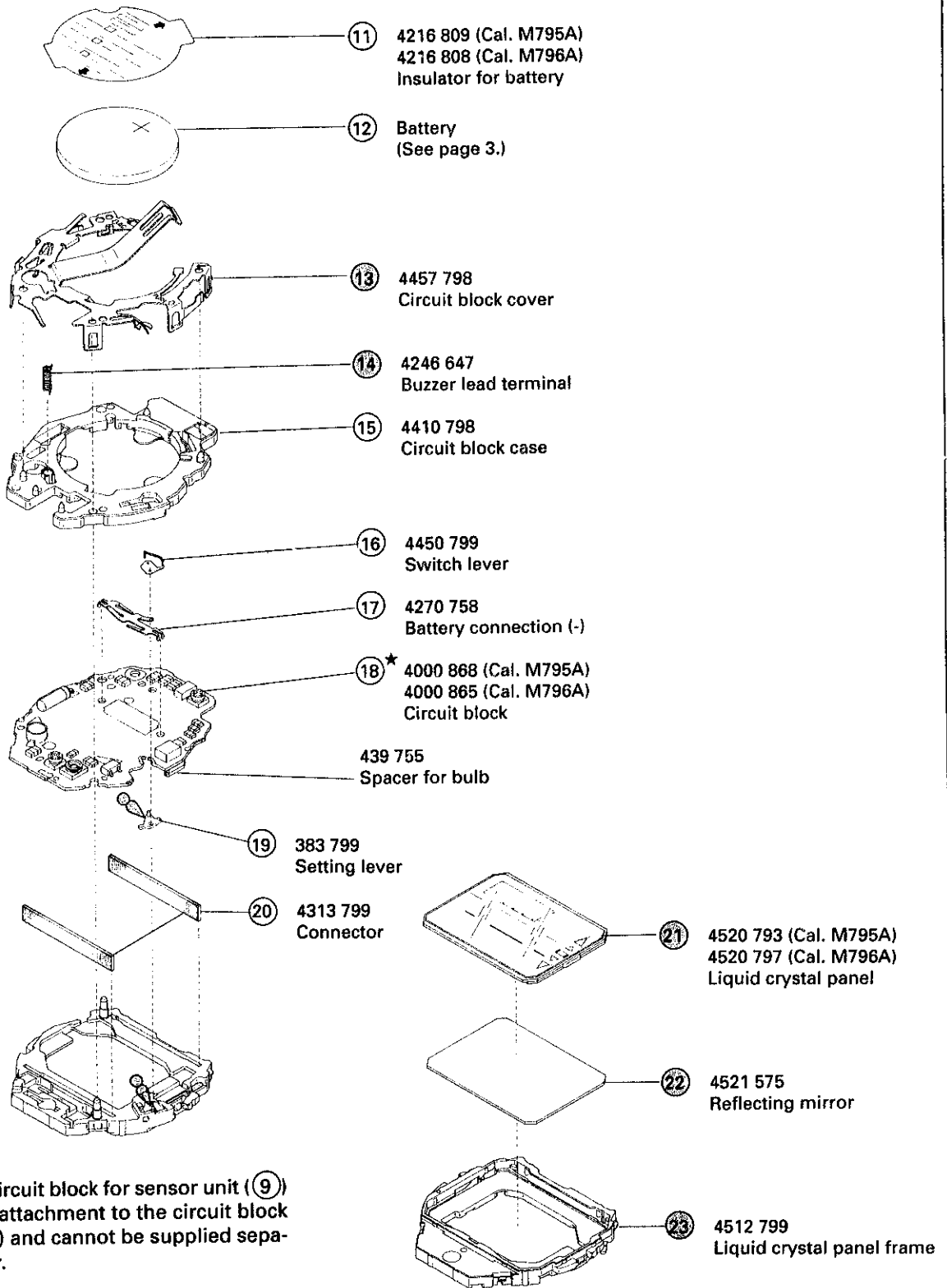

➡ Please see the remarks on the following pages.

TECHNICAL GUIDE

Cal. M795A, M796A

- The explanation here is only for the particular points of Cal. M795A and M796A.
- For the repairing, checking and measuring procedures, refer to the "TECHNICAL GUIDE, GENERAL INSTRUCTIONS".

I. STRUCTURE OF THE CIRCUIT BLOCK

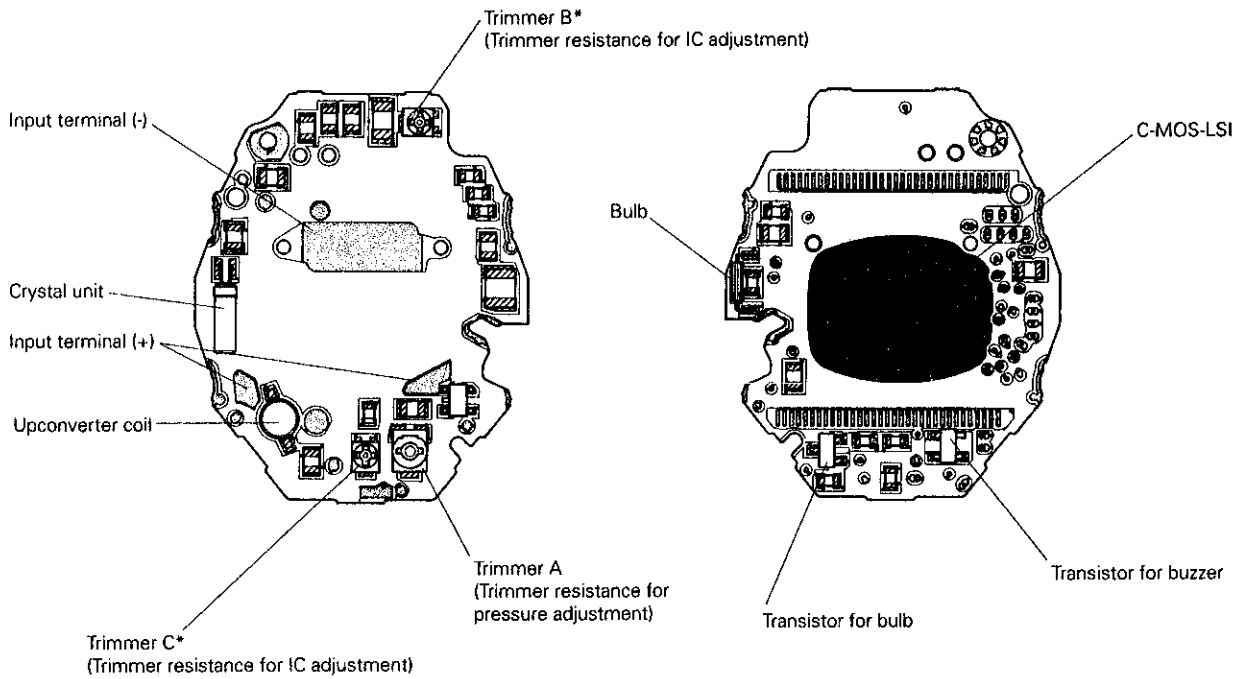

* Never turn Trimmer B and Trimmer C.

II. REMARKS ON INSTALLING THE BATTERY

After the battery is replaced with a new one, or after the battery is re-installed following the repairing procedures, be sure to reset the circuit by pressing down on the AC terminal of the circuit block and the circuit block cover with conductive tweezers.

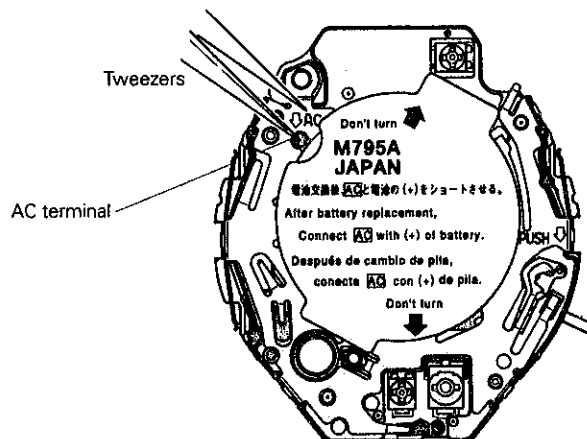

III. REMARKS ON DISASSEMBLING AND REASSEMBLING

6 Module

• How to remove

When removing the module from the case, remove Button A. To do so, pull it out while pressing the setting lever, as shown in the illustration.

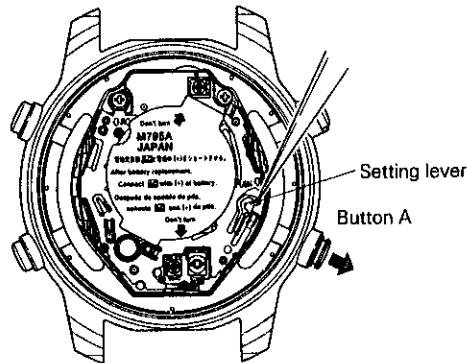

8 Sensor fixing plate

• How to remove

Slide the sensor fixing plate to the direction as indicated by the arrow in the illustration so that it is not caught by the screwed portion of the circuit block for sensor unit.

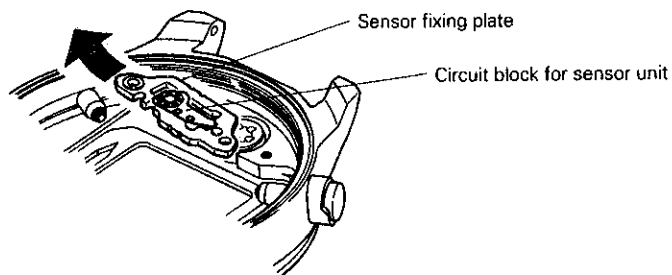

9 Circuit block for sensor unit

Do not touch the silicone gel surface of the sensor with tweezers or fingers.

If it is soiled, lightly rinse it with fresh water and leave it untouched until it is thoroughly dry.

When installing the gasket for sensor unit, take care not to damage the side face of the sensor.

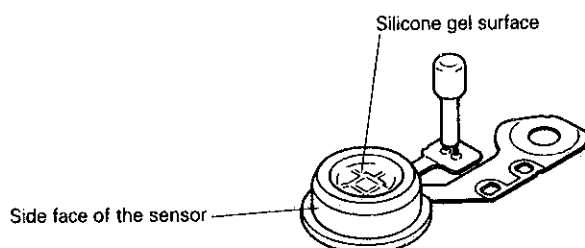

TECHNICAL GUIDE

Cal. M795A, M796A

13 Circuit block cover

Pry up the six hooking portions of the circuit block cover with the tip of a screwdriver to remove it.

When installing the circuit block cover, check that the hooking portions are securely set.

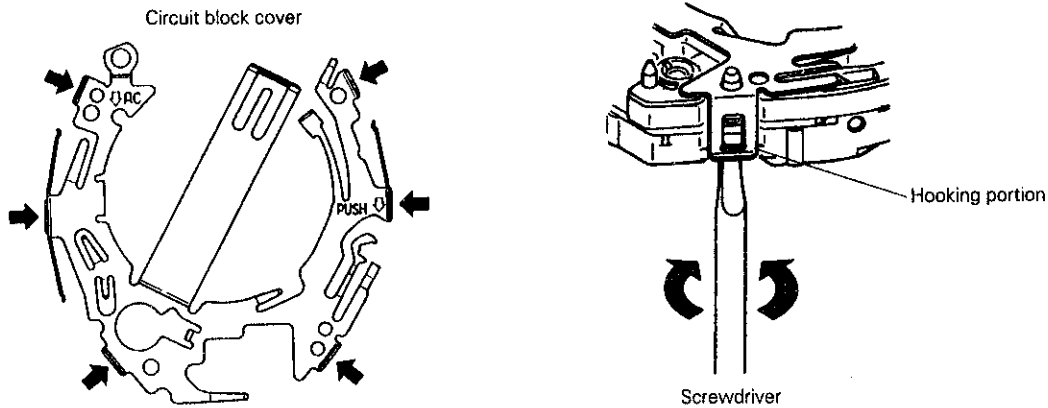

14 Buzzer lead terminal

After installing the buzzer lead terminal, turn it counterclockwise 30° to 40° to set it securely.



21 Liquid crystal panel

22 Reflecting mirror

23 Liquid crystal panel frame

When removing the liquid crystal panel and the reflecting mirror, insert the tip of a screwdriver into the hooking portion of the liquid crystal panel frame at the 6 o'clock position, and pry it up in the direction of the arrow as shown in the illustration.

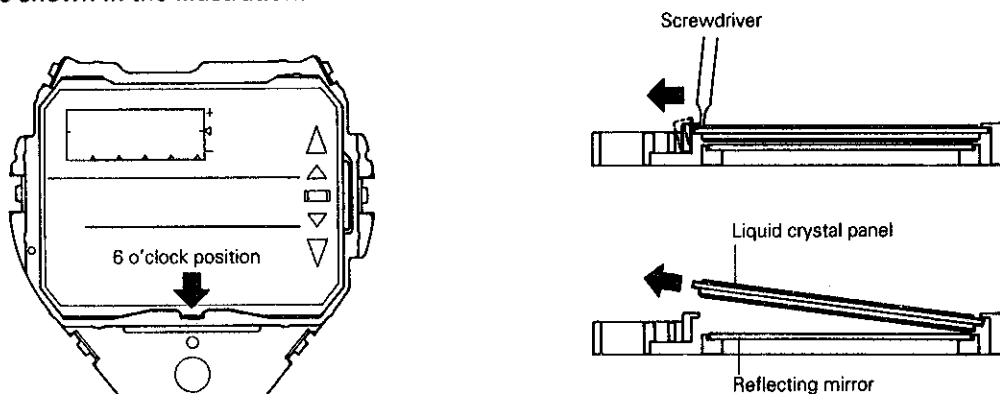

[Barometer adjustment in the test mode]

After replacing the circuit block, circuit block for sensor unit or module with a new one, the watch may not measure atmospheric pressure accurately. In this case, it is necessary to adjust the barometer by following the procedure below.

1. Set the watch to the test mode.

- 1) In the TIME/ATMOSPHERIC PRESSURE mode, press Button A to show the DEPTH/WATER TEMPERATURE mode.

[TIME/ATMOSPHERIC PRESSURE mode]

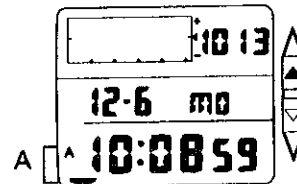

- 2) Press Button D once. The display flashes.

[DEPTH/WATER TEMPERATURE mode]

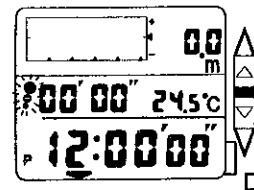

- 3) Immediately press Button C and D together and then release them when the display shown at right appears.

[Test mode]

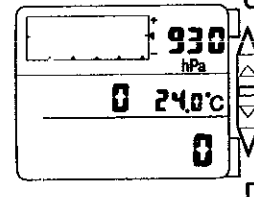

2. Open the case back and turn the trimmer resistance for pressure adjustment (Trimmer A) to set the atmospheric pressure within to ± 2 hPa of the actual atmospheric pressure.

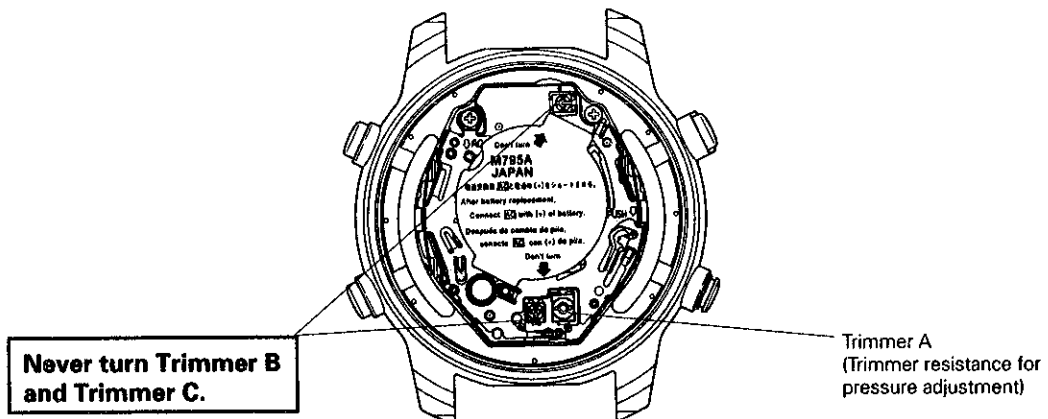

3. Press Button A to return to the DEPTH/WATER TEMPERATURE mode.

* After using the test mode, be sure to change the mode to another by pressing Button A, because long use of the test mode will shorten the battery life.

IV. VALUE CHECKING AND FUNCTION CHECKING

- Current consumption

For the whole of the module : less than 2.2 μ A

For the circuit block alone : less than 1.8 μ A

- Upconverter coil resistance

150 Ω ~ 190 Ω

TECHNICAL GUIDE

Cal. M795A, M796A

• Button operation and function checking

When checking the functions, operate the buttons as shown in the chart below. (The illustrations refer to Cal. M796A.)

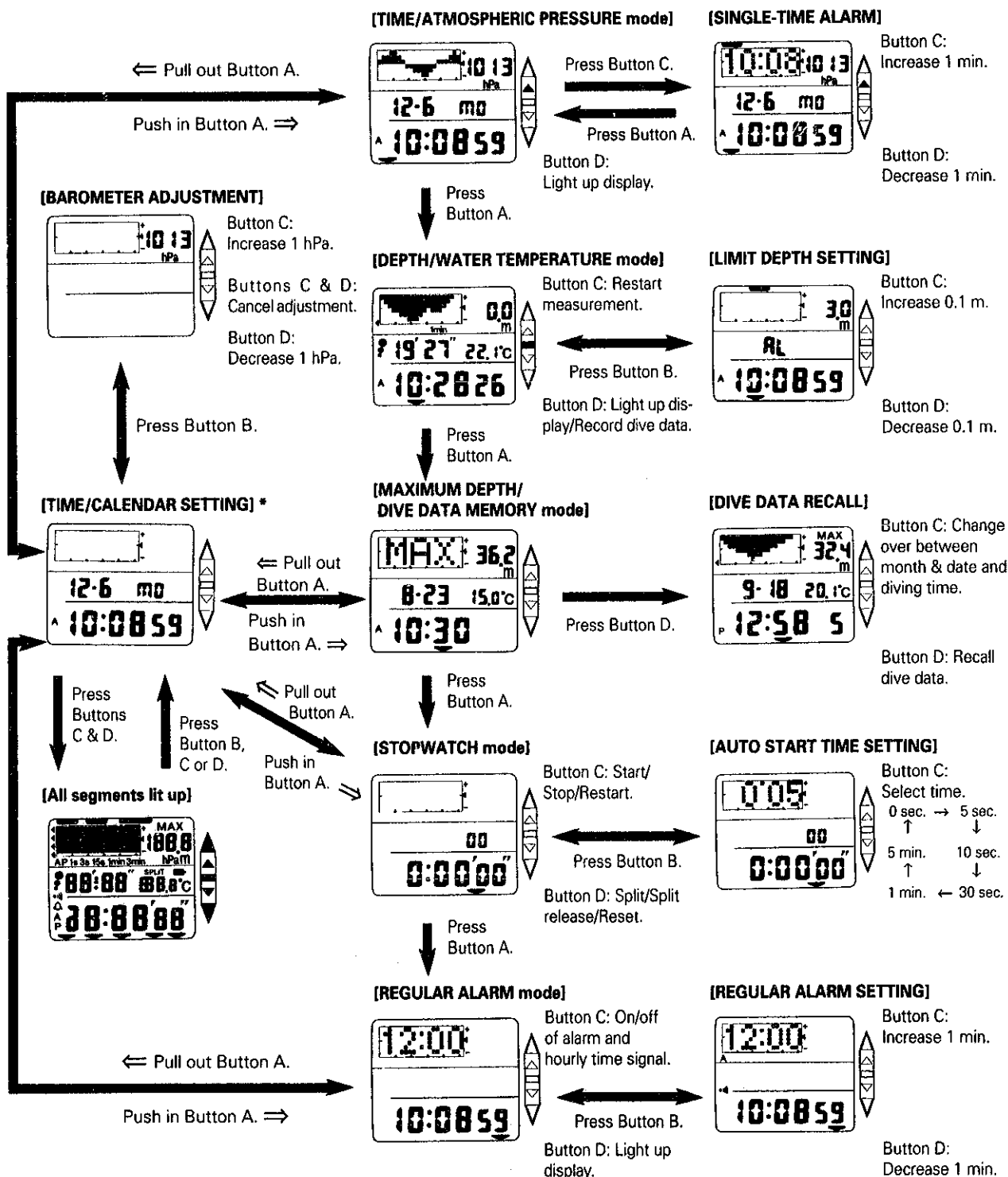

* Button operations in the TIME/CALENDAR SETTING display

Button C: Select digits [Seconds → Minutes → Hour → Month → Date → Day → 12-/24-hour indication]

Button D: Set digits

• Accuracy of the pressure sensor

[1] To measure the accuracy of the pressure sensor, use Water Resistance Tester S-470 developed for exclusive use with Cal. M7 Series.

Follow the procedure below.

- 1) Press Button A to show the DEPTH/WATER TEMPERATURE mode. The watch starts measuring the diving time, indicating that the depth measurement can be made.
- 2) Put the watch into the water tank of Water Resistance Tester S-470, and apply 1.00 kg/cm² of pressure.
- 3) Make a note of the depth displayed by the watch.
- 4) Apply pressure gradually, and make a note of the depth displayed by the watch when 3.00 kg/cm² of pressure is applied.
- 5) If the obtained depths fall within the range shown in the table below, the pressure sensor is normal and accurately measures the depth.

Pressure value of S-470	Depth display of Cal. M795A	Depth display of Cal. M796A
1.00 kg/cm ²	28 ~ 36 feet	8.5 ~ 11.0 m
3.00 kg/cm ²	89 ~ 104 feet	27.0 ~ 31.5 m

[2] If you do not have Water Resistance Tester S-470, you can check the accuracy of the pressure sensor using Water Resistance Tester S-460 if you have it at hand. In this case, be sure to replace the conventional pressure gauge of the S-460 tester with the Digital Depth Gauge Unit S-461 to make precise depth measurement checking possible.

Water Resistance Tester S-460 does not have a window to check the depth display of the watch. To check the accuracy of the depth measurement, therefore, use the maximum depth display of the watch as follows:

- 1) To begin with, clear the maximum depth in memory. In the MAXIMUM DEPTH/DIVE DATA MEMORY mode, press Button C and hold, and then press Button A for 2 to 3 seconds. The display flashes, and the maximum data in memory will be erased.
- 2) Press Button A to show the DEPTH/WATER TEMPERATURE mode.
- 3) Put the watch into the water tank of Water Resistance Tester S-460, and apply 1.00 kg/cm² of pressure.
- 4) Decrease the pressure, and take the watch out of the water.
- 5) Press Button A to show the MAXIMUM DEPTH/DIVE DATA MEMORY mode, and make a note of the maximum depth displayed by the watch.
- 6) Press Button A to show the DEPTH/WATER TEMPERATURE mode.

TECHNICAL GUIDE

Cal. M795A, M796A

- 7) Put the watch into the water tank of S-460, and apply 3.00 kg/cm² of pressure.
- 8) Decrease the pressure, and take the watch out of the water. Then, in the MAXIMUM DEPTH/DIVE DATA MEMORY mode, make a note of the maximum depth displayed by the watch.
- 9) If the obtained depths fall within the range shown in the table under procedure 1 in the previous page, the pressure sensor is normal and accurately measures the depth.

[3] If you do not have Water Resistance Tester S-470, or S-460 and S-461, it is not possible to precisely check the accuracy of the depth measurement of the watch. In that case, use Air Pressure Water Resistance Tester S-451A only to check if the pressure sensor functions.

- 1) Press Button A to show the DEPTH/WATER TEMPERATURE mode.
- 2) Put the watch into the chamber of Air Pressure Water Resistance Tester S-451A, and apply 3 atmospheres of pressure/bar.*
- 3) Decrease the pressure, and take the watch out of the chamber.
- 4) Press Button A to show the MAXIMUM DEPTH/DIVE DATA MEMORY mode, and make a note of the maximum depth displayed by the watch.
- 5) If the obtained depth falls within the range of 82 and 116 feet (Cal. M795A) or 25.0 ~ 35.0 m (Cal. M796A), the pressure sensor is considered to be normal.

* Never apply air pressure to the watch for more than 3 to 4 minutes as this may damage the pressure sensor unit.

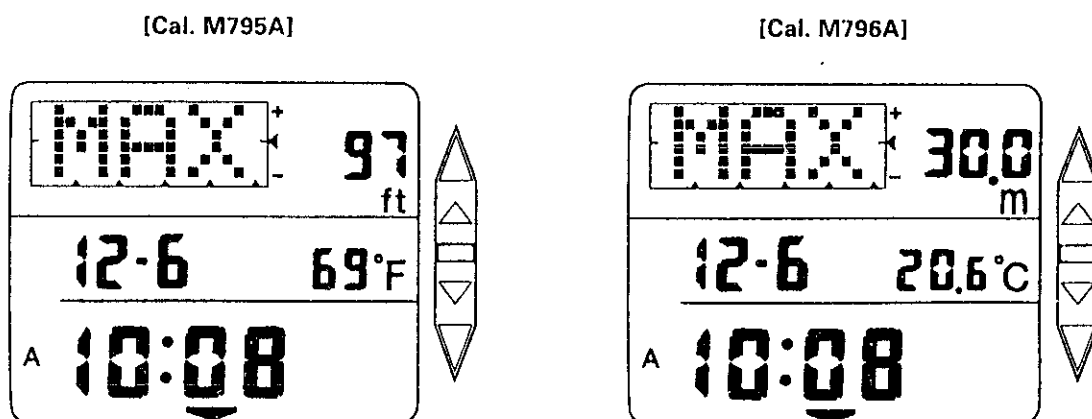

With any of the three procedures described above, clear the data in memory after the checking procedure is completed, in the following manner:

In the MAXIMUM DEPTH/DIVE DATA MEMORY mode, press Button C and hold, and then press Button A for 2 to 3 seconds. The display flashes, and the data in memory will be erased.