	Technical Guide		TG-19-C-045-E	B
	Made by: pelrom	Date: 23.03.2006	Modifications: see last page	

# CALIBRE 3301

	Version A	Version B
<p>12''' Ø 27 mm</p>		
Height on movement	6.85 mm	
Power reserve	52 h	
Number of jewels	33	
Frecuency	4 Hz (28'800 A/h)	

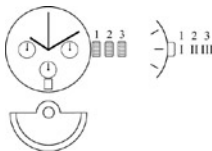

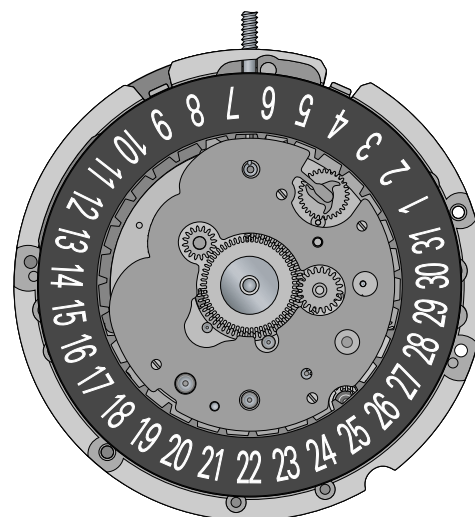
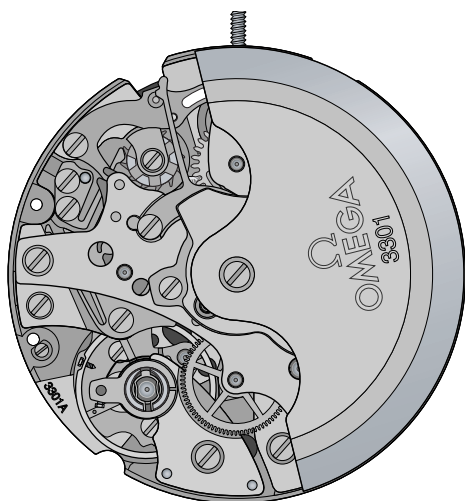

Automatic movement, exclusive Omega chronograph, date, COSC certified. Chronograph system with column-wheel. 30-min. minute counter and 12-h hour counter. Omega balance system without index.



	<b>Page</b>
Calibre 3301	1
General information	3-4
Tools / Torque values for screw tightening / Lubricants	
Differences between the versions	5
Exploded views	6-10
Dial side	6
Movement side	7
Movement side	8
Movement side	9
Dial side	10
Spare parts list & illustrations	11-15
Spare parts list & illustrations	11
Spare parts list & illustrations	12
Spare parts list & illustrations	13
Spare parts list & illustrations	14
Specific information	16-19
Chronograph wheel function / Description of chronograph system	16
Chronograph setting	17
Forces for driving in hands / Epilamage	18
Instantaneous rate	19



**Date correction**



Date correction should not be performed between 10 pm and 2 am.

**Technical changes on version "A"**

Screw for hammer-lever banking bridge		
Old version	New version	Notes
72233036033	72233036034	The new version shall mandatorily be fitted for repairs
		
Length = 1.90 with guide	Length = 1.95 without guide, threaded up to the end as of week 07/2002	

Column wheel operating lever		
Old version	New version	Notes
722330355040	722330355040	The new version shall mandatorily be fitted for repairs
		
Could break	More rugged New version as of week 32/2003	

Minute counter jumper		
Old version	New version	Notes
722330355143	722330355143	The new version shall mandatorily be fitted for repairs
		
Could break	More rugged New version as of week 42/2003	

Hammer operating lever		
Old version	New version	Notes
722330355047	7223303A55048	The new version shall mandatorily be fitted for repairs
		
Resetting too fast	Ensures correct resetting and hand strength as of week 32/2003	

### **Balance bridge, complete (ref. 10.05824°)**

Balance bridge complete with No Chronometer are not available (see CS-Info Calibre No 33).

### **Key points**

The three intermediate driving wheels for ratchet wheel (32.083) must be correctly lubricated with Moebius SYNT-HP-1300 Sans Colorant. Insufficient lubrication could lead to the formation of burrs or chips and hinder the correct winding of the barrel. Cleaning would not be sufficient to remove all this.

Due to the movement construction, there are various screw lengths. To avoid problems at assembly, group identical screws together for cleaning.

Demagnetize the movement before disassembling.

### **Screwing torques according to screw thread**

Screw dia.	Minimum torque CNm	Maximum torque CNm
Thread dia. ≤ S 0.50 mm	0.8	1
Thread dia. S 0.6 to S 0.8 mm	1.5	2.5
Thread dia. S 0.9 to S 1.0 mm	2.5	3
Thread dia. S 1.2 mm	3	3.5
Thread dia. S 1.4 and >	3.5	4

### **Mandatory tools:**

#### **The fitting of hands**

Movement holder for hands-fitting	<b>Ref.</b> 507 0001
Kit of tool for hand-setting	507 0011











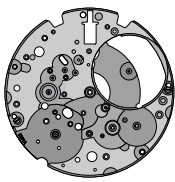
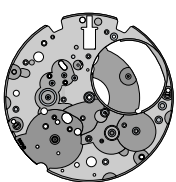



#### **Movement**

Mainspring winders	502 150 0009
Key for rate adjustment	502 200 0501
Tool for checking escapement functions	506 0002

#### **Lubricants**

Moebius SYNT-A-LUBE 9010 (2ml)	<b>Ref.</b> 504 200 0001
Moebius SYNT HP-1300 Sans Colorant	504 5013
Moebius 9504	504 5014
Moebius 9415	504 100 0003
Kluber P125	504 100 0071

## Differences between versions 3301A and 3301B

	3301A (4 Hz)	3301B (4 Hz)
Main plate	 ref. 7223301A10020 Engraving 3303A	 ref. 7223301B10020 Engraving 3303B
Balance, complete	 ref. 722330340055 Cylindrical pivots Ø 0.07 mm	 ref. 7223303B40055 Conical pivots Ø 0.08 mm
Shock-absorbers, top	  Jewel hole Ø 0.09 mm ref. 722330332025 Nickel-plated	  Jewel hole Ø 0.08 mm ref. 7223313B32027 Gold-plated
Shock-absorbers, bottom	  ref. 722330332062 Jewel hole Ø 0.09 mm Nickel-plated	  ref. 7223313B32068 Jewel hole Ø 0.08 mm Gold-plated
In settings, upper	 ref. 7223303A32127 Jewel hole Ø 0.09 mm	 ref. 7223313B32127 Jewel hole Ø 0.08 mm
In settings, lower	 ref. 7223303A32167 Jewel hole Ø 0.09 mm	 ref. 7223313B32167 Jewel hole Ø 0.08 mm

## Parts listed in order of assembly

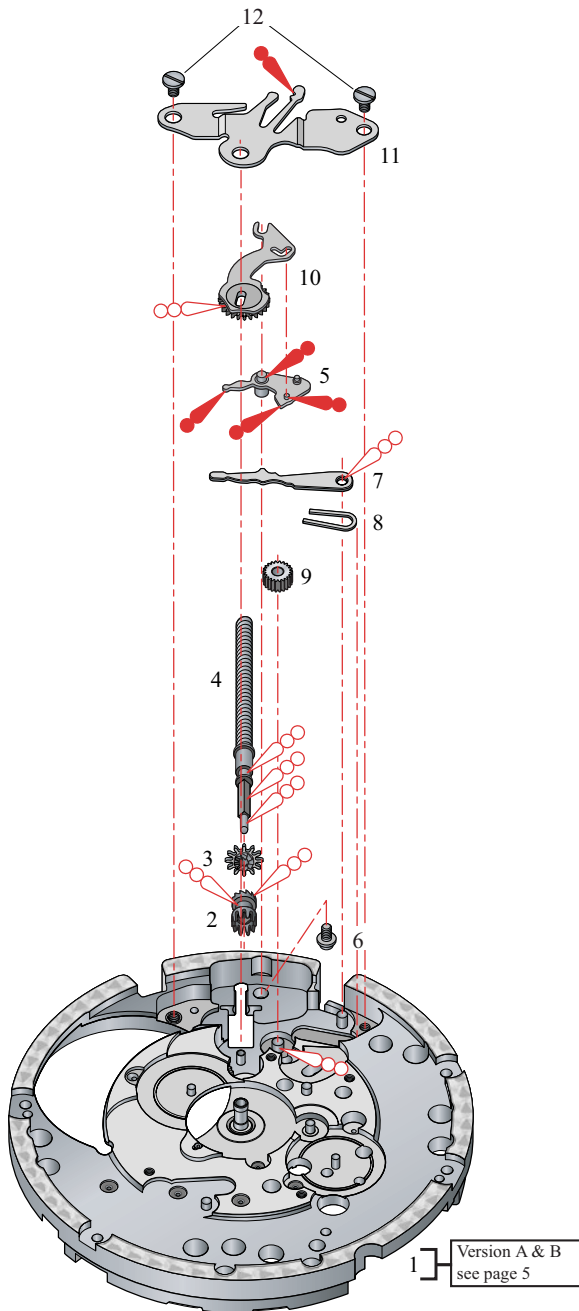

1 = 1002007	7 = 51050
2 = 311211	8 = 61100
3 = 31120	9 = 33082
4 = 51010	10 = 51052
5 = 51083	11 = 51090
6 = 6407 (1x)	12 = 7035 (2x)

 Moebius SYNT HP-1300 Sans Colorant  
 Moebius 9405



Parts listed in order of assembly

1 = 30012	9 = 35033
2 = 30014	10 = 56070
3 = 30025	11 = 65040
4 = 10048	12 = 6204 (1x)
5 = 7031 (2x)	13 = 10041
6 = 20010	14 = 7031 (2x)
7 = 35030	15 = 6011 (1x)
8 = 35032	

-  Moebius SYNT HP-1300 Sans Colorant
-  Moebius SYNT-A-LUBE 9010
-  Kluber P125

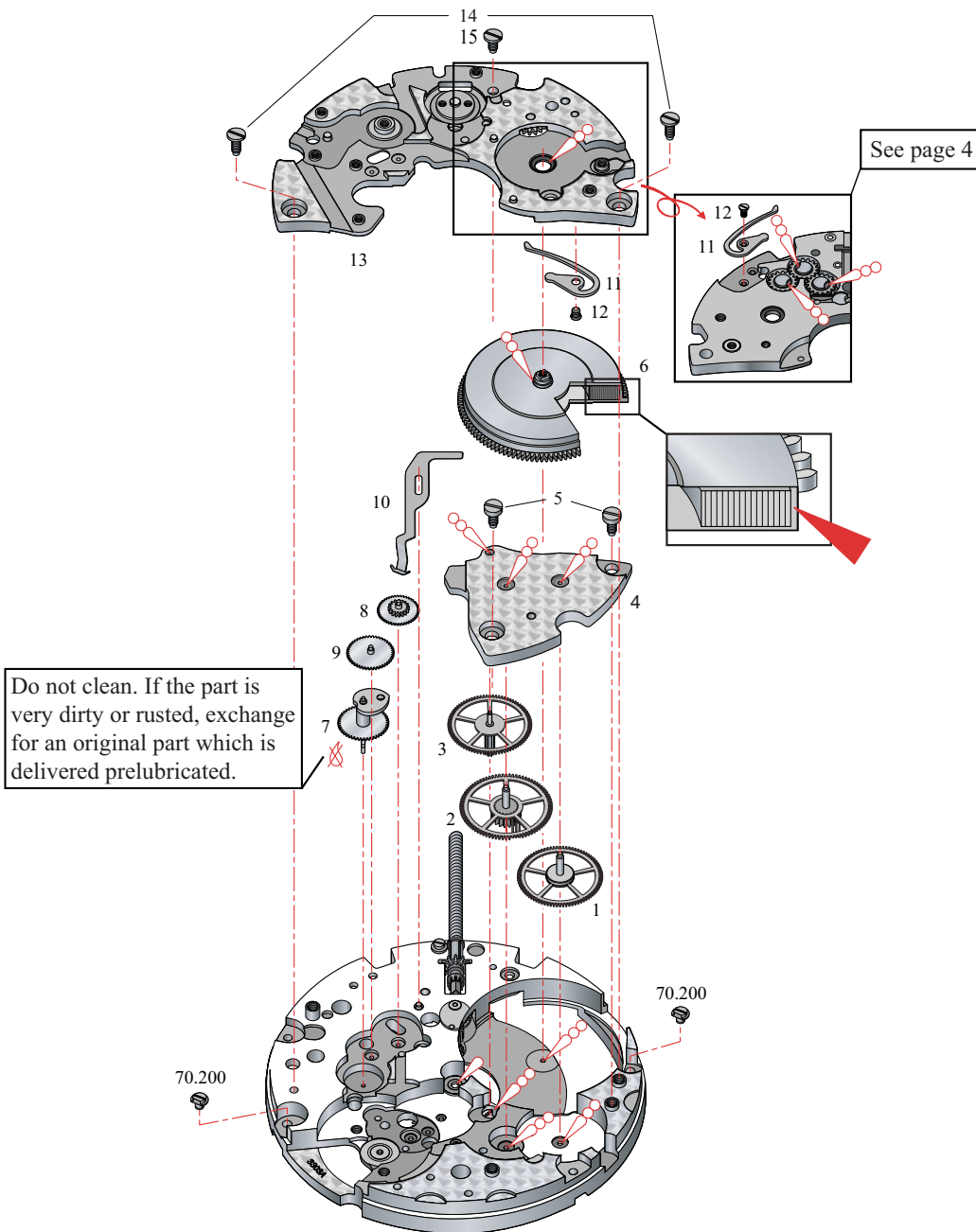

## Parts listed in order of assembly

1 = 61080	20 = 55090
2 = 51120	21 = 6004 (1x)
3 = 7008 (1x)	22 = 30027
4 = 31022	23 = 55240
5 = 6019 (1x)	24 = 55048
6 = 31023	25 = 6004 (1x)
7 = 81136	26 = 35031
8 = 6204 (2x)	27 = 35012
9 = 55040	28 = 55248
10 = 6022 (1x)	29 = 15040
11 = 55180	30 = 7031 (3x)
12 = 10615	31 = 7033 (1x)
13 = 6034 (1x)	32 = 65047
14 = 55130	33 = 6004 (2x)
15 = 6004 (2x)	34 = 40010
16 = 30040	35 = 10057
17 = 35010	36 = 8204 (2x)
18 = 55100	37 = 10058/40055
19 = 6004 (1x)	38 = 7031 (1x)

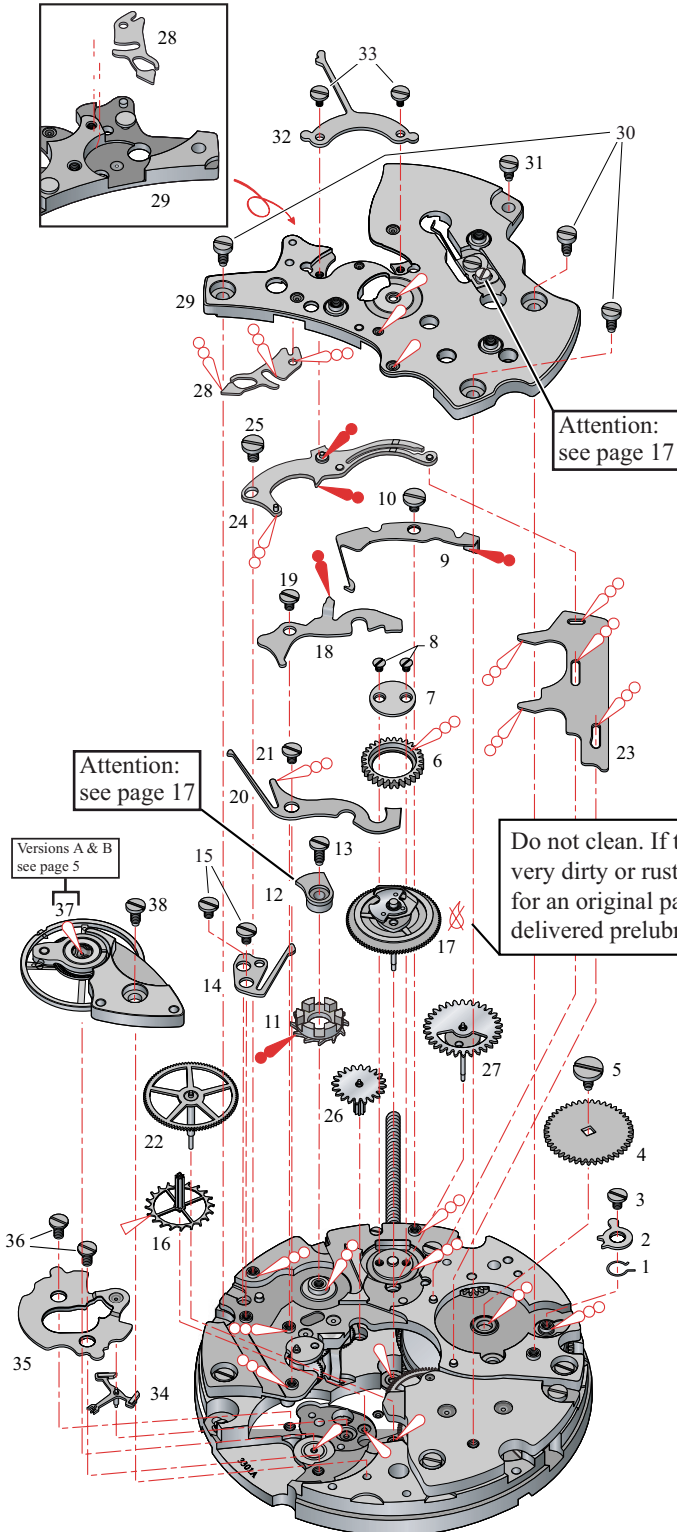

- Moebius SYNT HP-1300 Sans Colorant
- Moebius SYNT-A-LUBE 9010
- Moebius 9504
- Moebius 9415



# Exploded views - Movement side

## Parts listed in order of assembly



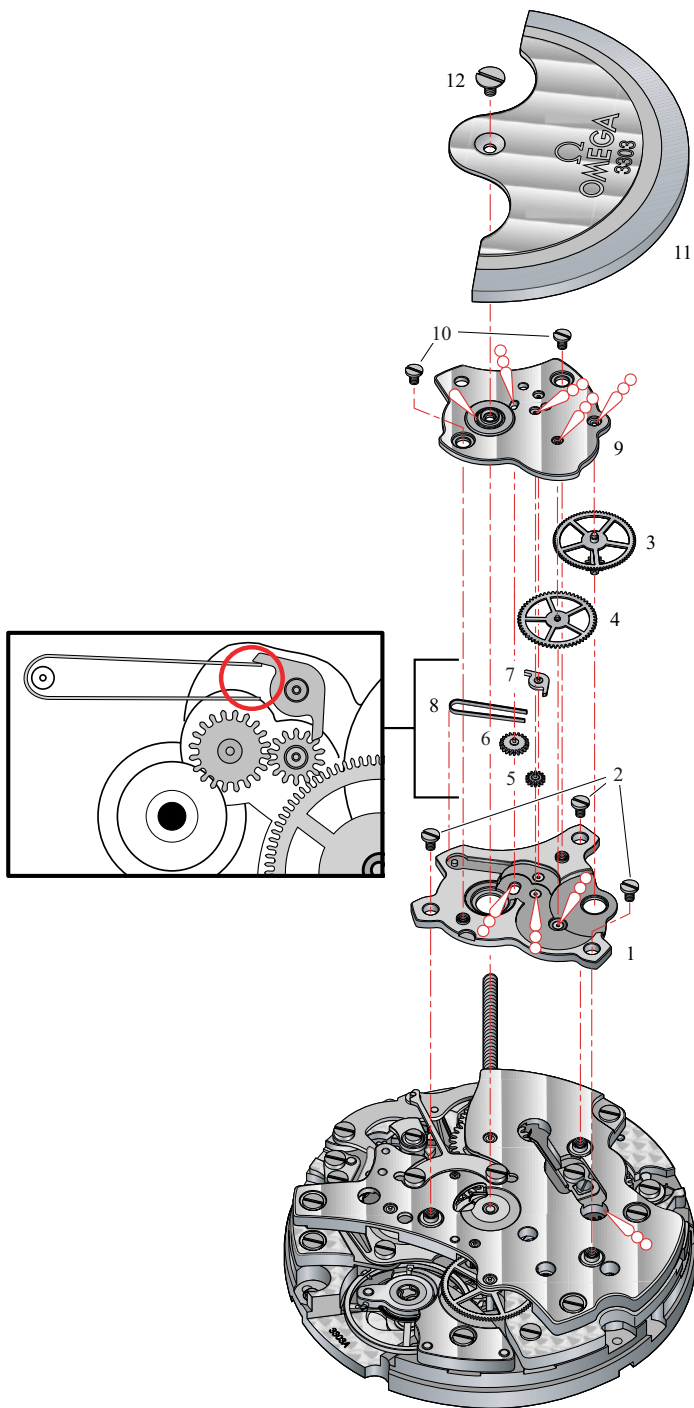

- |                |                |
|----------------|----------------|
| 1 = 61080      | 7 = 52053      |
| 2 = 7033       | 8 = 62101      |
| 3 = 7008 (1x)  | 9 = 12050      |
| 4 = 31022 (1x) | 10 = 6003 (2x) |
| 5 = 6019 (1x)  | 11 = 22019     |
| 6 = 31023      | 12 = 8200 (1x) |

- |   |                                    |
|---|------------------------------------|
|  | Moebius SYNT-A-LUBE 9010           |
|  | Moebius SYNT HP-1300 Sans Colorant |









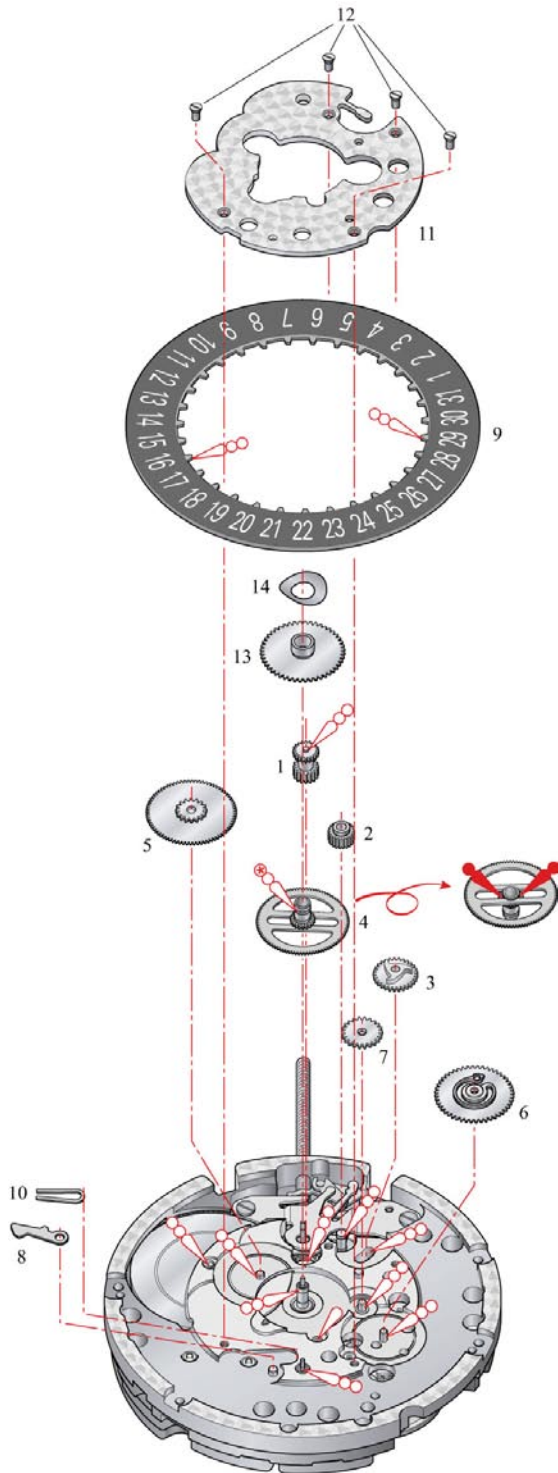



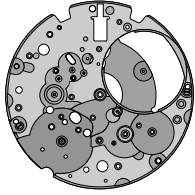
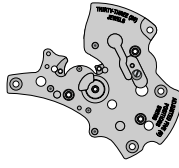
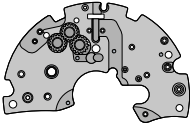

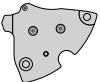







Parts listed in order of assembly

1 = 31102	8 = 53080
2 = 33083	9 = 91440
3 = 53200	10 = 63030
4 = 31080	11 = 13105
5 = 31041S2	12 = 6210 (4x)
6 = 33020	13 = 31046
7 = 33011	14 = 66220

































-  Moebius SYNT-A-LUBE 9010
-  Moebius 9504
-  Moebius SYNT HP-1300 Sans Colorant
-  Moebius SYNT HP-1300 Sans Colorant



























## Spare parts list & illustrations

Main plate, pre-assembled	Version	Reference	Chronograph bridge	Version	Référence
	3301A	722330110020		3301A	722330115040
	3301B	7223301B10020		3301B	7223301B15040
Barrel bridge, jewelled	Version	Reference	Barrel, complete	Version	Reference
	3301A	7223301A10041		3301A	722330320010
	3301B			3301B	
Wheel train bridge, jewelled	Version	Reference	Mainspring with bridle	Version	Reference
	3301A	722330110048		3301A	722330320100
	3301B			3301B	
Pallet bridge	Version	Reference	Oscillating wheel	Version	Reference
	3301A	722330310057		3301A	722330122019
	3301B			3301B	
Balance bridge, complete	Version	Reference	Intermediate wheel	Version	Reference
	3301A	722330110058° (see page 4)		3301A	722330330012
	3301B	7223301B10058° (see page 4)			
Hammer operating limitation bridge	Version	Reference	Great wheel	Version	Reference
	3301A	722330310615		3301A	722330330014
	3301B				
Automatic device framework, jewelled	Version	Reference	Third wheel	Version	Reference
	3301A	722330312030		3301A	722330330025
	3301B				
Automatic device bridge	Version	Reference	Second wheel	Version	Reference
	3301A	722330112050		3301A	722330330027*
	3301B				
Date indicator maintaining plate	Version	Reference	Escape wheel	Version	Reference
	3301A	722330113105		3301A	722330330040
	3301B				



















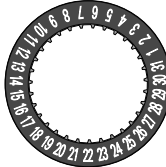



## Spare parts list & illustrations

Ratchet wheel	Version	Reference	Reduction wheel	Version	Reference
	3301A	722330331022		3301A	722330332031S2
	3301B			3301B	
Crown wheel	Version	Reference	Jewelled shock-absorber, top	Version	Reference
	3301A	722330331023		3301A	722330332025
	3301B				3301B
Minute wheel	Version	Reference	Jewelled shock-absorber, bottom	Version	Reference
	3301A	722330331041S2		3301A	722330332062
	3301B				3301B
Stud for intermediate driving wheel for ratchet wheel	Version	Reference	In settings, upper	Version	Reference
	3301A	722330331044		3301A	7223303A32127
	3301B				3301B
Retaining stud on spring of sliding gear countershaft	Version	Reference	In settings, lower	Version	Reference
	3301A	722330331051		3301A	7223303A32167
	3301B				3301B
Hour wheel	Version	Reference	Ratchet wheel driving wheel	Version	Reference
	3301A	722330331046*		3301A	72233033203301
	3301B				
Cannon pinion with driving wheel	Version	Reference	Intermediate driving wheel for ratchet wheel	Version	Reference
	3301A	722330331080*		3301A	722330332083
	3301B				
Setting wheel	Version	Reference	Wig-wag pinion	Version	Reference
	3301A	722330331100		3301A	722330332104
	3301B				
Motion work setting wheel	Version	Reference	Stop pinion	Version	Reference
	3301A	722330331102		3301A	722330132105
	3301B				
Winding pinion	Version	Reference	Intermediate date wheel	Version	Reference
	3301A	722330331120		3301A	722330333011
	3301B				
Sliding pinion	Version	Reference	Date indicator driving wheel	Version	Reference
	3301A	722330331121		3301A	722330333020
	3301B				

## Spare parts list & illustrations

Date corrector intermediate setting wheel 1	Version	Reference	Yoke	Version	Reference
	3301A	722330333082		3301A	722330351050
	3301B			3301B	
Date corrector intermediate setting wheel 2	Version	Reference	Rocking bar	Version	Reference
	3301A	722330333083		3301A	722330351052
	3301B			3301B	
Chronograph wheel	Version	Reference	Setting lever	Version	Reference
	3301A	7223303335010*		3301A	722330351083
	3301B			3301B	
Minute-counting wheel	Version	Reference	Setting lever jumper	Version	Reference
	3301A	7223303335012*		3301A	722330351090
	3301B			3301B	
Hour-counting wheel	Version	Reference	Click	Version	Reference
	3301A	7223303335030*		3301A	722330351120
	3301B			3301B	
Driving wheel for counters	Version	Reference	Stop click	Version	Reference
	3301A	7223303335031		3301A	722330352053
	3301B			3301B	
Hour counter additional driving wheel 1	Version	Reference	Date jumper	Version	Reference
	3301A	7223303335032		3301A	722330353080
	3301B			3301B	
Hour counter additional driving wheel 2	Version	Reference	Date corrector	Version	Reference
	3301A	7223303335033		3301A	722330353200
	3301B			3301B	
Pallet fork	Version	Reference	Column wheel operating wheel	Version	Reference
	3301A	722330340010		3301A	722330355040
	3301B			3301B	
Balance complete with stud	Version	Reference	Hammer operating lever	Version	Reference
	3301A	722330340055		3301A	7223303A55048
	3301B	7223303B40055		3301B	
Stud support	Version	Reference	Clutch rocker	Version	Reference
	3301A	722330340210		3301A	722330355090
	3301B			3301B	
Winding stem	Version	Reference	Clutch lever	Version	Reference
	3301A	722330351010		3301A	722330355100
	3301B			3301B	

## Spare parts list & illustrations

Column wheel jumper	Version	Reference	Column wheel operating lever spring	Version	Reference
	3301A	722330355130		3301A	722330365040
	3301B			3301B	
Minute counter jumper	Version	Reference	Hammer operating lever spring	Version	Reference
	3301A	722330355143		3301A	722330365047
	3301B			3301B	
Chronograph column-wheel	Version	Reference	Hour wheel friction spring	Version	Reference
	3301A	722330355180		3301A	722330366220
	3301B			3301B	
Chronograph and minute hammer	Version	Reference	Crown wheel core	Version	Reference
	3301A	722330355240		3301A	722330381136
	3301B			3301B	
Hour hammer	Version	Reference	Date indicator	Version	Reference
	3301A	722330355248		3301A	722330391440*
	3301B			3301B	* Several versions available
Eccentric screw	Version	Reference	Dial fastener	Version	Reference
	3301A	722330355445		3301A	722330370200
	3301B			3301B	
Balance stop lever	Version	Reference	Screw for stud	Version	Reference
	3301A	722330356070		3301A	72233034002
	3301B			3301B	
Ratchet sliding wheel spring	Version	Reference	Screw for automatic device bridge	Version	Reference
	3301A	722330361073		3301A	72233036003
	3301B			3301B	
Click spring	Version	Reference	Screw for column wheel jumper	Version	Reference
	3301A	722330361080		3301A	72226016004
	3301B			3301B	
Yoke spring	Version	Reference	Screw for barrel bridge (small)	Version	Reference
	3301A	722330361100		3301A	72233036011
	3301B			3301B	
Stop click spring	Version	Reference	Screw for ratchet wheel	Version	Reference
	3301A	722330362101		3301A	72233036019
	3301B			3301B	
Date jumper spring	Version	Reference	Screw for column wheel operating lever	Version	Reference
	3301A	722330363030		3301A	72233036022
	3301B			3301B	















Screw for hammer-lever banking bridge	Version	Reference
	3301A	72233036034
	3301B	
Screw for column wheel operating lever spring	Version	Reference
	3301A	72233036204
	3301B	
Crown boss screw	Version	Reference
	3301A	72233036204
	3301B	
Screw for motion work bridge	Version	Reference
	3301A	72233036210
	3301B	
Screw for setting lever	Version	Reference
	3301A	72233036407
	3301B	
Screw for click	Version	Reference
	3301A	72233037008
	3301B	
Screw for train wheel bridge	Version	Reference
	3301A	72233037031
	3301B	
Screw for barrel bridge	Version	Reference
	3301A	72233037031
	3301B	
Screw for chronograph bridge	Version	Reference
	3301A	72233037031
	3301B	
Screw for balance-bridge	Version	Reference
	3301A	72233037031
	3301B	
Screw for chronograph bridge (smaller)	Version	Reference
	3301A	72233037033
	3301B	
Screw for chronograph device bridge	Version	Reference
	3301A	72233037033
	3301B	
Screw for setting lever jumper	Version	Reference
	3301A	72233037035
	3301B	
Screw for oscillating weight	Version	Reference
	3301A	72233038200
	3301B	
Screw for pallet bridge	Version	Reference
	3301A	72233038204
	3301B	

Fig. 1.0 a

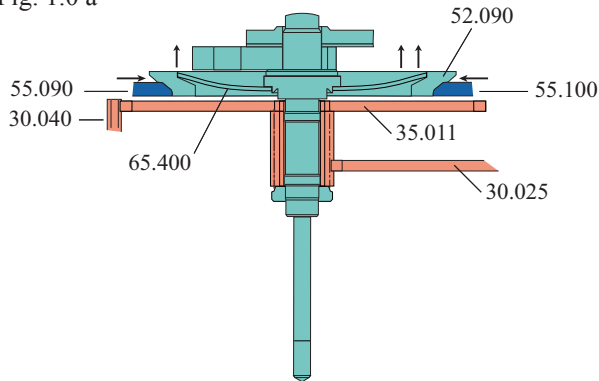
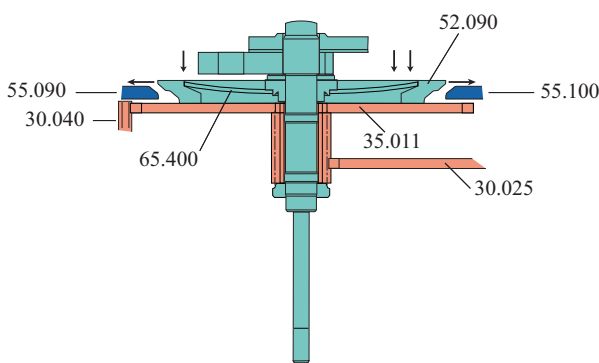

Fig. 1.0 b



## 1.0 Chronograph wheel function

### Chronograph wheel 35.010\*

Chronograph wheel 35.010\* is equipped with a coupling system by which the chronograph can be coupled with and uncoupled from the movement's gear-train.

### Do not clean

Chronograph wheel (35.010\*):

The chronograph wheel can only be lubricated during the manufacturing process. Cleaning damages the lubrication and could leave cleaning solution residue at the chronograph wheel, which interferes with operating and timing.

### Chronograph stoppage position

In chronograph stoppage position, clutch disc 52.090 is raised following clamping by clutch rocker 55.090 and clutch lever 55.100, thus avoiding contact with chronograph pinion 35.011 which is constantly coupled with the movement's gear-train.

### Chronograph operating position

In chronograph operating position, clutch disc 52.090 is released simultaneously by clutch rocker 55.090 and clutch lever 55.100. Pushed by chronograph wheel friction spring 65.400, it comes to rest on chronograph pinion 35.011 which will drive it in its travel.

Fig. 1.1

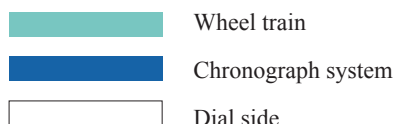

## 1.1 Description of chronograph system

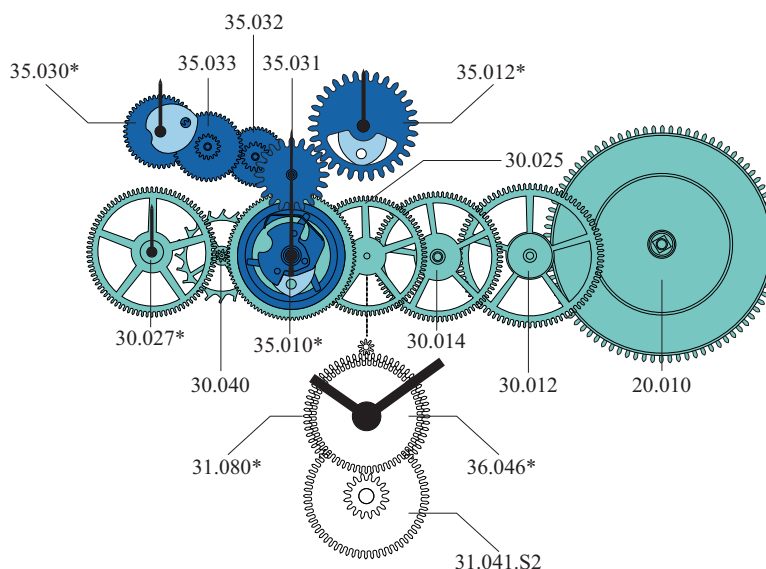



Fig. 2.1

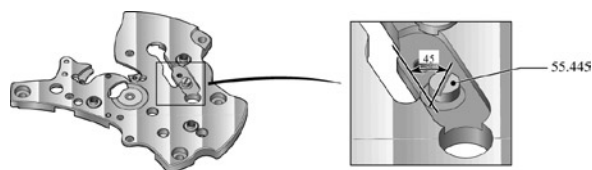

Fig. 2.2

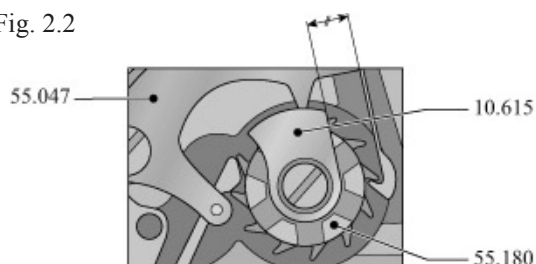

Fig. 2.3

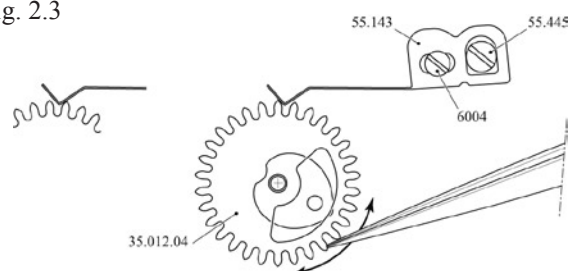

Fig. 2.4 - Drawing 1

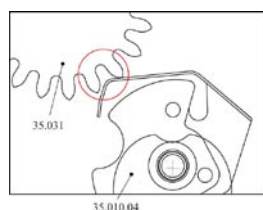

Fig. 2.4 - Drawing 2

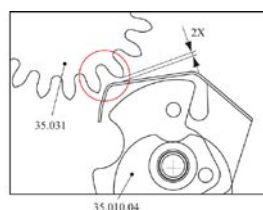
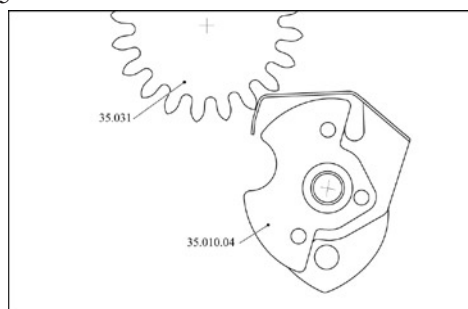

Fig. 2.5



## 2.0 Chronograph setting

### 2.1 Check on the eccentric screw for the counter jumper (55.445)

The eccentric screw (55.445) of the counter jumper (55.143) must be positioned as in the drawing. The slot of the eccentric screw (55.445) must form an angle of 45° in relation to the recess in the bridge. An additional correction is subsequently possible when the chronograph is being set. Do not forget to place the hour hammer (55.248) under the bridge and lubricate it.

### 2.2 Hammer-lever banking bridge (10.615)

The hammer-lever banking bridge (10.615) prevents the hammer operating lever (55.047) from moving into an unsuitable position.

It should be positioned above the hammer operating lever (55.047) and its straight flank should be parallel to the hammer operating lever spring (65.047).

### 2.3 Check on position of minute counter (35.012\*)

Place the chronograph in reset position. Using a plastic or brass point, move the minute counter (35.012\*) slightly to the left and right. It is important that the minute counter should return correctly to its original position. With the eccentric screw (55.445), the position of the counter jumper (55.143) can be corrected.

### 2.4 Check on location of chronograph finger in reset position

Check the location of the chronograph finger in reset position. To ensure good synchronisation between the second counter and the minute counter, the chronograph finger should be between the position of «slight contact against the tooth» (see drawing 1) and a maximum distance of twice the thickness of the finger blade (see drawing 2).

### 2.5 Chronograph finger operating safety

Put the chronograph in START position. Check that the minute counter jump is operating correctly by checking the penetration of the chronograph finger.

### 2.6 Checking the minute jump

In the START position, drive the chronograph hand with a brass or plastic point until the minute jumps. The difference in relation to the position of the chronograph's seconds hand in the zero setting position has a tolerance of 2/5 second. Check the function of the counter jumper (55.143) on the hand.

### 3.0 Forces for driving in hands











Designation	Minimum force (N)	Maximum force (N)	Support (pivot)
Hour hand	10	50	—
Minute hand	10	50	—
Second hand (chrono) in centre (version A)	40	60	yes
Second hand (chrono) in centre (version B)	28	45	yes
Second hand (small)	10	40	yes
Hour counter hand	25	50	yes
Minute counter hand	25	50	yes

### 4.0 Epilage

#### 4.1 Partial epilame coating

Designation	Reference	
Pallet fork **	Ref. 40010	

#### 4.2 Components not to be coated with epilame after cleaning

Designation	Reference	
Balance fitted on balance bridge	Ref. 40055 + Ref. 10058°	
Shock-absorber, top*	Ref. 32127	
Shock-absorber, bottom*	Ref. 32167	
Pallet bridge	Ref. 10057	
Barrel complete	Ref. 20010	
Barrel-mainspring	Ref. 20100	
Hour-counting wheel ***	Ref. 3503004	 
Chronograph wheel ***	Ref. 3501004	 

\* Do not coat the shock-absorber settings with epilame but coat the cap jewels with epilame

\*\* Pallet fork: Steep only the two gathering pallets in epilame

\*\*\* Do not clean the chronograph wheel and the hour-counting wheel.

## 5.0 Instantaneous rate

### 5.1 Check of the instantaneous rate

Demagnetize the movement before the checks.

The rate can be checked with a Witschi Watch Expert or a similar apparatus capable of acoustic measurements. The lift angle has to be set to 51 degrees.

The timing of the movement has to be according to the Omega timing specification list.

**For the designations and tolerances please consult Working Instructions No. 5 & 28.**

Fig. 5.0

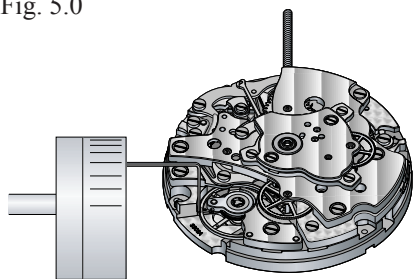
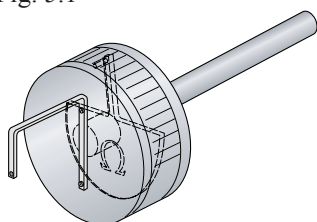
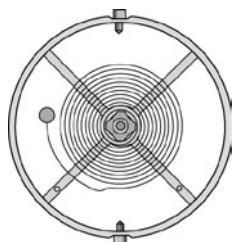

Fig. 5.1



REF. 502 200 0501

Fig. 5.2



### 5.2 Rate adjustment

To adjust the rate on an encased movement, a special correction tool has been developed (Fig. 5.0). One complete revolution of both balance regulating screws represents a rate correction as per the table below. The correction can be read on the scale of the circumference of the tool. One division of the scale represents a rate correction of one second (Fig. 5.1).

In order to be easily identifiable for the correction procedure, one of the adjusting screws is located between 2 arms marked with a dot (Fig. 2). Adjustment correction must be performed

Versions A & B identical	
One correction revolution =	52 seconds
One graduation =	1 second

## Modifications of Technical Guide versions

Technical Guide versions				
First version:	23.03.2006	Version A	Made by:	Pelrom
Last version:	20.04.2006	Version B		

Modifications of Technical Guide version B	
Old version (A)	New version (B)
Tool for checking escapement functions Ref. 506 0002 / Page 4	Tool for checking escapement functions Ref. 506 0004 / Page 4
	Additional drawing of barrel reversed / Page 7
	Additional lubricant point on column wheel on exploded view / Page 8