

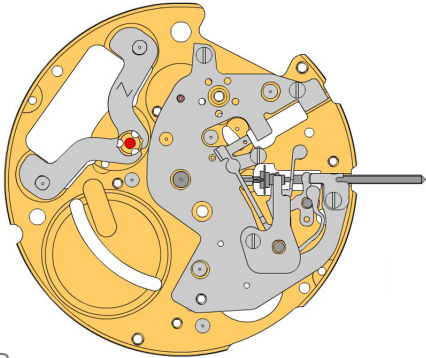

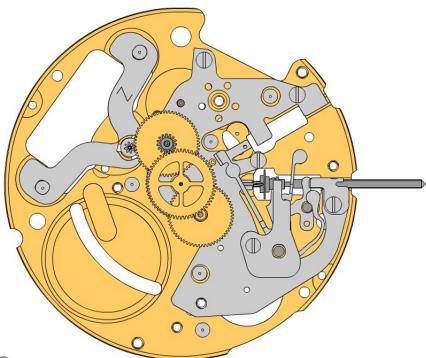

A















B



C

2000.628.G 1.		Main plate
2130.204.CO 2.		Setting mechanism cover Setting mechanism cover held by 3 screws 4000.321.
4000.321 3.		Screw

3017.057 4.		Setting lever
3015.074 5.		Yoke (3 positions) Tensioning the spring arm.
3001.042.FI 6.		Sliding pinion
3000.189.CO 7.		Setting stem
2020.166 8.		Yoke bridge Yoke bridge held by 1 screw 4000.328.
4000.328 9.		Screw
2130.199 10.		Stem maintaining plate Stem maintaining plate held by 1 screw 4000.312.
4000.312 11.		Screw
3622.042 12.		Stator Mark [Z] on stator.

3715.103.RK 13.		Rotor
3147.056.CO 14.		Intermediate wheel
3122.059.CO 15.		Third wheel
3136.160.CO 16.		Center second wheel (Aig.1)

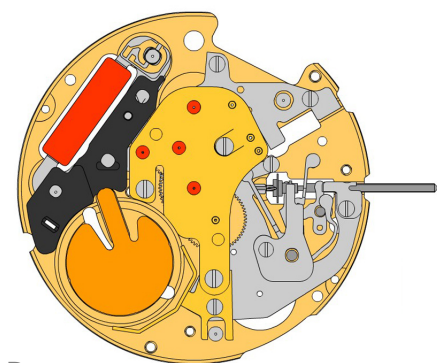



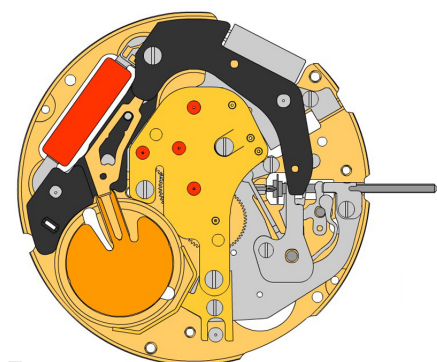



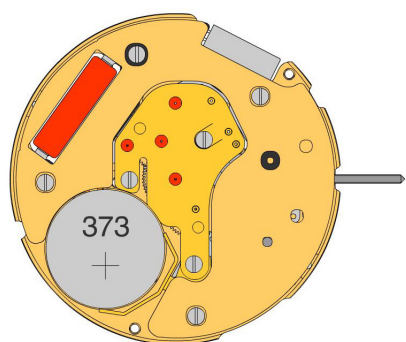





D











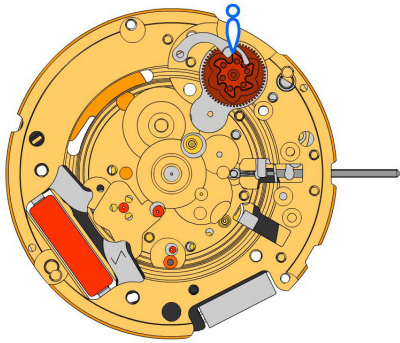
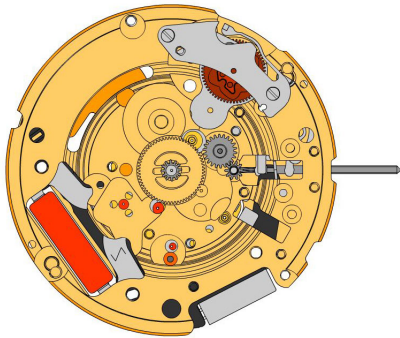
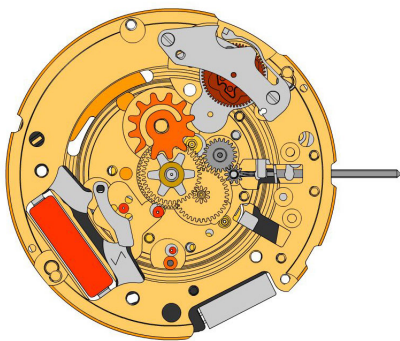





E



F





2020.180.G 17.		Train wheel bridge Train wheel bridge held by 3 screws 4000.279.
4000.279 18.		Screw
3601.117.G 19.		Battery clamp + Bridle held by 1 screw 4000.244.
4000.244 20.		Screw
3621.060.RK 21.		Coil Attention: Please hold the coil only on the grey coil core.
3603.074 22.		Bridle (-) insulator
3603.075 23.		Battery insulator
3601.116 24.		Bridle - Place Bridle as shown on graphics.
3612.181 25.		Electronic module Electronic module held by 1 screw 4000.318.
4000.318 26.		Screw
2130.168.G.M01.6003B 27.		Electronic module cover Electronic module cover held by 3 screws 4000.102. Electronic measurements may be realised now.
4000.102 28.		Screw
3600.031.HGF 29.		Battery 373

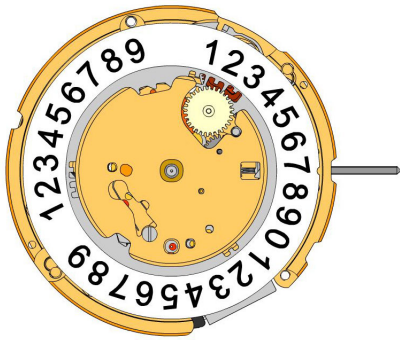

G

H

I

2000.628.G 30.		Main plate
3004.232 31.		Tens indicator driving wheel The short tooth of the tens indicator driving wheel must point to the center of the movement.
3500.060 32.		Tens jumper
2130.171 33.		Tens jumper maintaining plate Tens jumper maintaining plate held by 2 screws 4000.332. Tensioning the spring arm.
4000.332 34.		Screw
3004.182.FI 35.		Setting wheel
3004.183.FI 36.		Intermediate setting wheel
3305.305.CO 37.		Cannon pinion with driver (Aig.1)
3007.073.CO 38.		Minute wheel
3301.271.CO 39.		Hour wheel (Aig.1)
3315.001 40.		Friction spring
3004.187 41.		Date indicator driving wheel
3500.061 42.		Date jumper

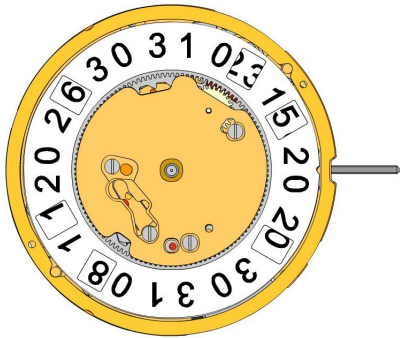









J

3504.217.AF.1.A 43.		Units indicator (standard) Nick of the indicator at 3 o' clock.
3147.057 44.		Tens intermediate wheel
2130.169 45.		Date indicator maintaining plate Date indicator maintaining plate held by 1 screw 4000.312
4000.312 46.		Screw
3905.070 47.		Date jumper spring Insert the date jumper spring in the provided opening.



K

3504.218.AF.1.A 48.		Tens indicator (standard) Nick of the indicator at 3 o' clock.
2130.170.G 49.		Date mechanism maintaining plate Date mechanism maintaining plate held by 3 screws 4000.312.
4000.312 50.		Screw
3506.075.G 51.		Dial support

8200 52.		Moebius 8200
9014 53.		Moebius 9014
124 54.		Jismaa 124
9020 55.		Moebius 9020

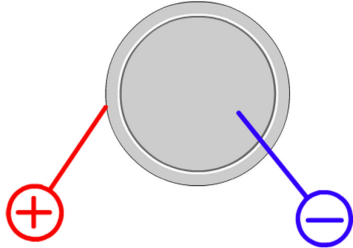

Battery	373
Voltage	1.55 V

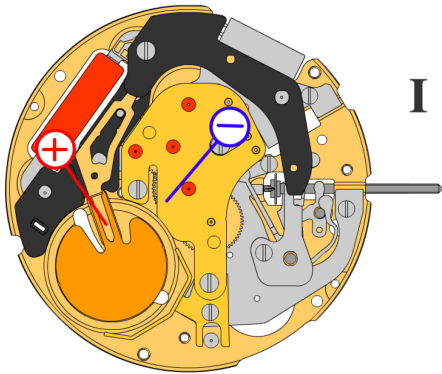

*Setting stem in position I, calendar not in gear,
60 s measuring interval for rate and consumption:*

Typical consumption	1.03 μA
Maximal consumption	1.85 μA
Rate	-10s/M. .. +20s/M.
Lower working voltage limit	1.20 V

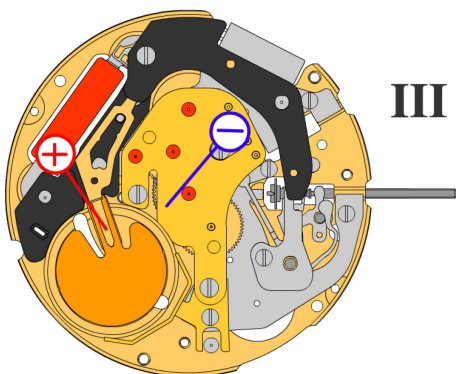

Setting stem in position III, 60 s measuring interval:

Typical consumption	0.10 μA
Maximal consumption	0.30 μA

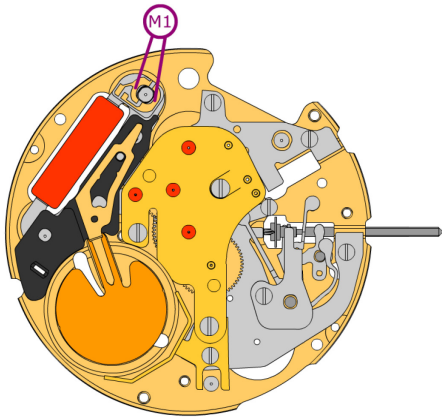

Coil resistance M1

1.61 k Ω .. 1.81 k Ω

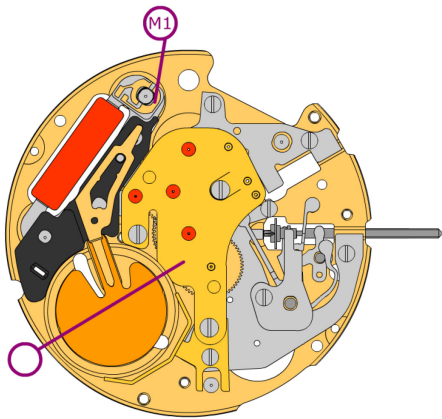

Coil isolation M1

∞ k Ω