

SEIKO

DIGITAL QUARTZ

Cal. S321A

**PARTS
CATALOGUE**

Cal. S321A

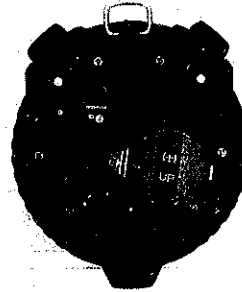

1/2

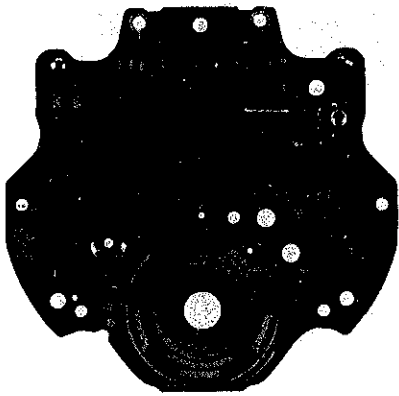

4001 807

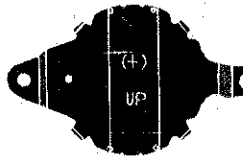

4225 801



4245 820



4246 809



4295 807



4313 807



4313 808



4454 807



4510 632



☆ Matsushita BR2016



022 906

2/1

Cal. S321A

Characteristics

Casing diameter : 69.3 × 61.5 mm

Maximum height : 16.1 mm

Frequency of quartz crystal oscillator : 32,768 Hz (Hz=Hertz Cycles per second)

Display medium : Nematic liquid crystal, FE-Mode

Regulation system : Trimmer condenser

Timer display

Free timer display

PART NO.	PART NAME	PART NO.	PART NAME
4001 807	Circuit block		
4225 801	Battery clamp		
4245 820	Side switch spring		
4246 809	Buzzer lead terminal		
4295 807	Rotary switch cam		
4313 807	Connector (A)		
4313 808	Connector (B)		
4454 807	Rotary switch cam spring		
4510 632	Liquid crystal panel		
022 906	Circuit block screw		
4457 807	Piezoelectric element		
☆Matsushita BR2016 ☆Maxell CR2016 ☆Sanyo CR2016 ☆SEIKO CR2016	Lithium battery		

Remarks :

Liquid crystal Panel

☆4510 632 } Be sure that combination between the color of panel cover and Liquid crystal panel
 ☆4510 633 } should be matched according to the "SEIKO Quartz Casing Parts Catalogue".

Battery

☆Matsushita BR2016 } The substitutive battery might be added to the applied battery in the future.
 ☆Maxell CR2016 } In that case, please refer to separate "BATTERY LIST FOR SEIKO
 ☆Sanyo CR2016 } **QUARTZ WATCHES**".
 ☆SEIKO CR2016 } Note that SEIKO battery is marked with "SEIZAIKEN" on its (+) side.

☆⇨ Please see remarks.

Part numbers in light letters are not shown in photos.

TECHNICAL GUIDE

SEIKO DIGITAL QUARTZ

CAL. S321A

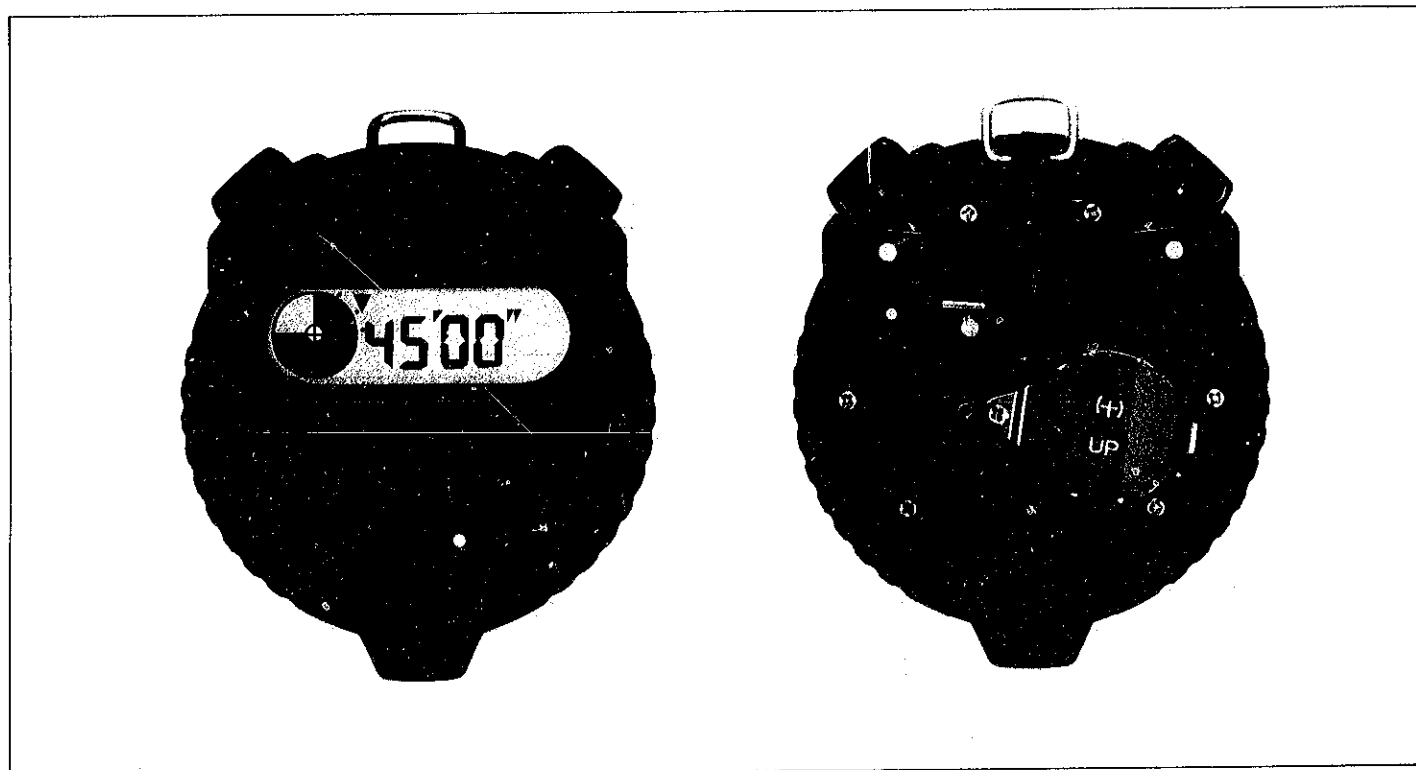

I. SPECIFICATIONS

Item		Cal. No.	S321A
Display medium		Nematic Liquid Crystal, FEM (Field Effect Mode)	
Liquid crystal driving system		Multiplex driving system	
Display system		<ul style="list-style-type: none"> • Preset timer display (preset timer modes) • Free timer display • Free timer set display • Stopwatch display 	
Additional mechanism		<ul style="list-style-type: none"> • Display off • Count-down display/count-up display changeover function • Overtime measurement function • Graphic display 	
Loss/gain		Equivalent to a monthly rate of 30 seconds (at normal temperature range)	
Module size	Outside diameter	69.3 mm between 6 o'clock and 12 o'clock sides 61.5 mm between 3 o'clock and 9 o'clock sides	
	Height	16.1 mm	
Regulation system		Trimmer condenser	
Measuring gate by quartz tester		Any gate can be used.	
Battery		Lithium battery SEIKO (SEIZAIKEN) CR2016, Sanyo CR2016, Maxell CR2016, Matsushita BR2016 Battery life is approximately 2 years. (when the timer/stopwatch is used for 2 hours a day and the warning sound 5 times a day) Voltage: 3.0V	

II. STRUCTURE OF THE CIRCUIT BLOCK

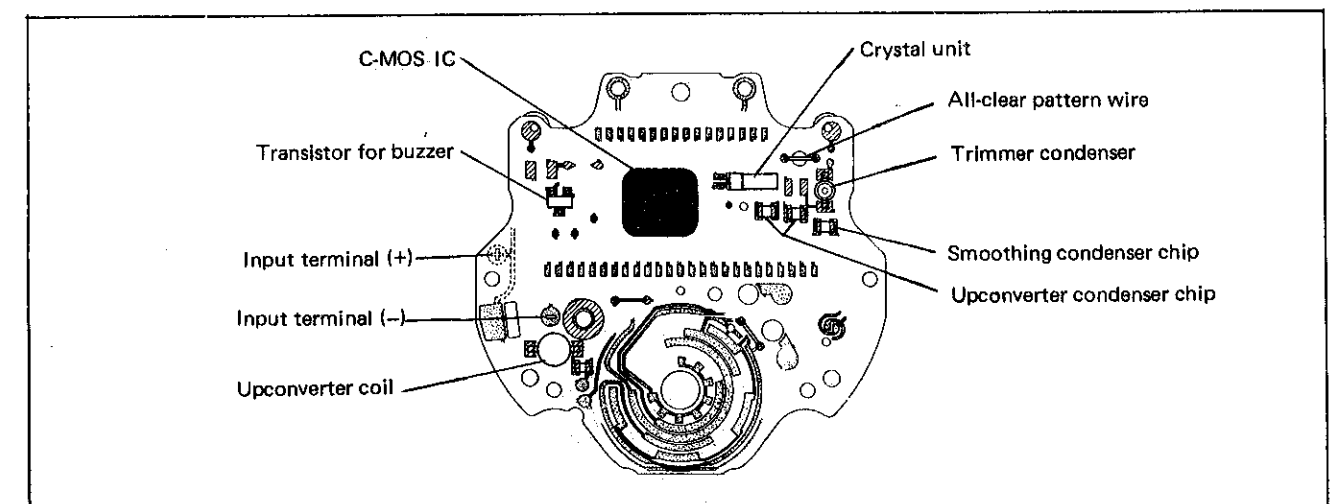

III. DISPLAY FUNCTION

● Display and button operation

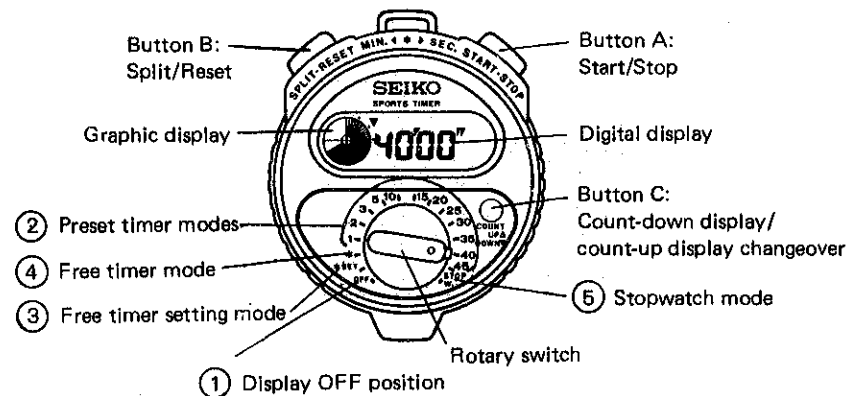

① OFF mode (Position on the dial: OFF)

The display is turned off for power saving when the timer/stopwatch is not in use.

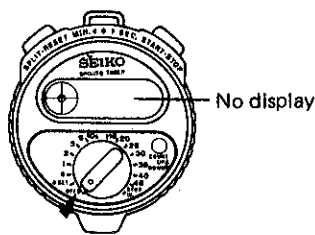

② Preset timer display (Positions on the dial: 1 ~ 45 min.)

④ Free timer display (Position on the dial: *)

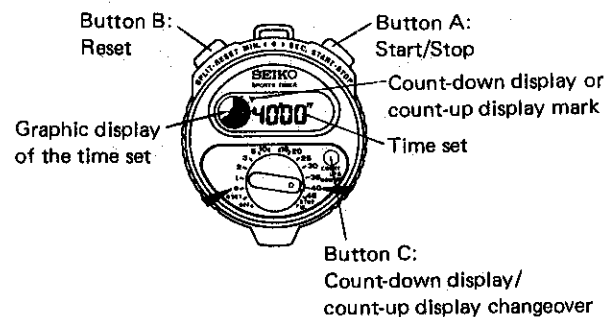

③ Free timer setting display (Position on the dial: *SET)

The timer can be set for a desired amount of time (up to 60 minutes).

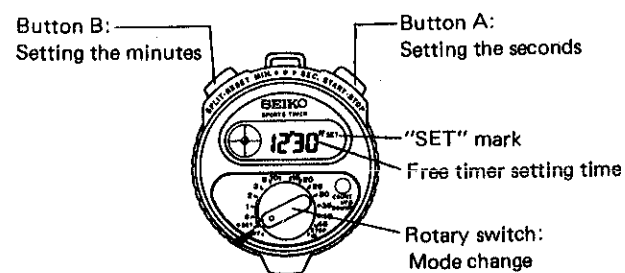

⑤ Stopwatch display (Position on the dial: STOPW.)

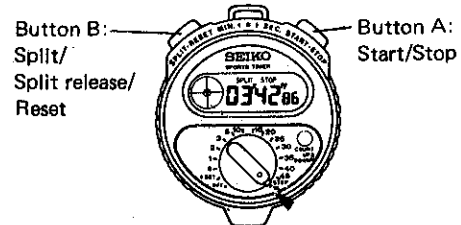

* Depressing buttons A and B at the same time resets the digits to '00'00'.

IV. DISASSEMBLING, REASSEMBLING, AND LUBRICATING

List of the screws used

Shape	Part No.	Name
	022 906	Circuit block screw (7 pcs.)

Disassembling procedures Figs.: ① → ②③

Reassembling procedures Figs.: ②③ → ①

Lubricating: Types of oil
 Silicone grease 500,000 c.s.
 SEIKO Watch Oil S-6

1. Case back screw ~ Rotary switch

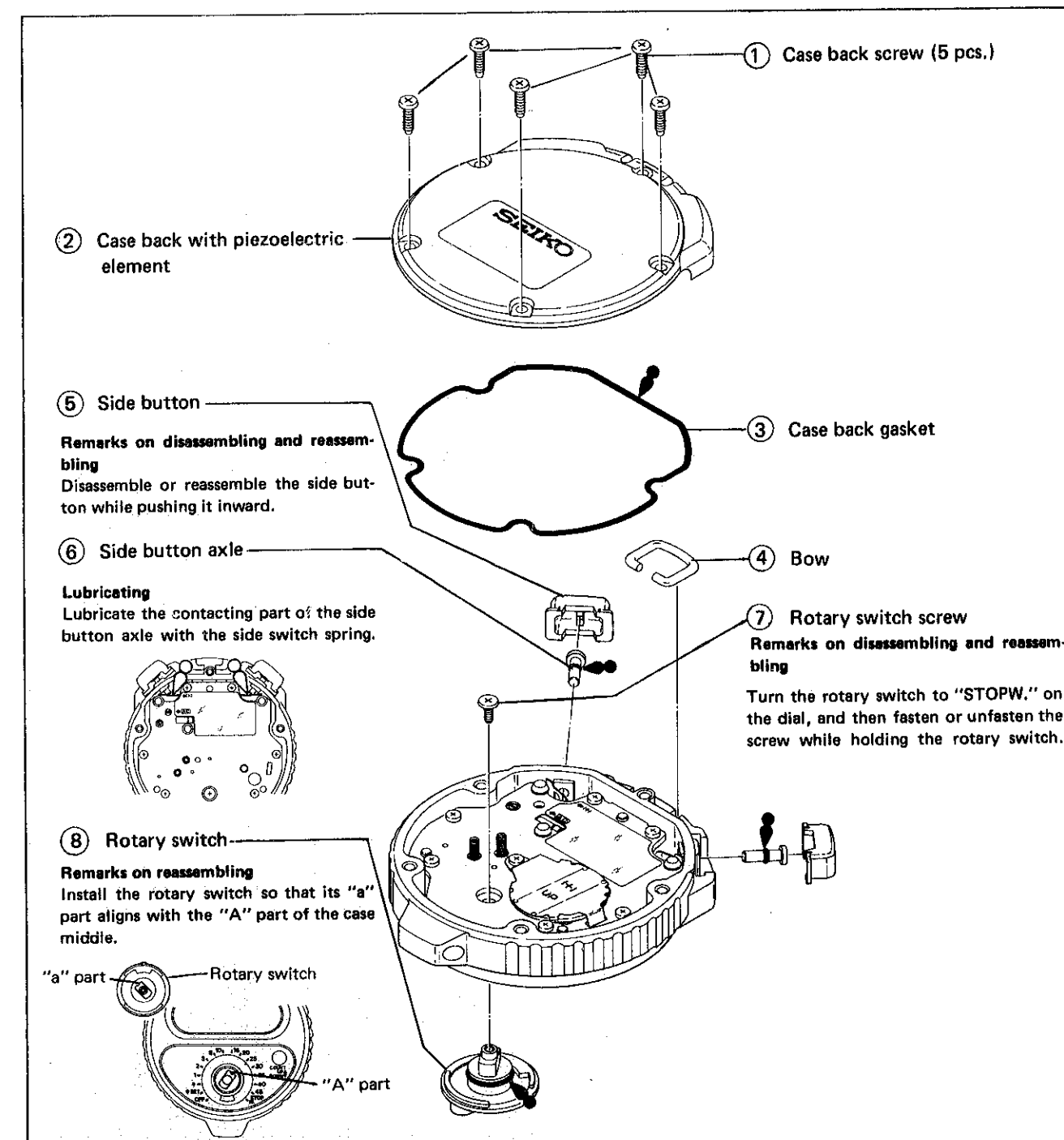

2. Circuit block screw ~ Case middle

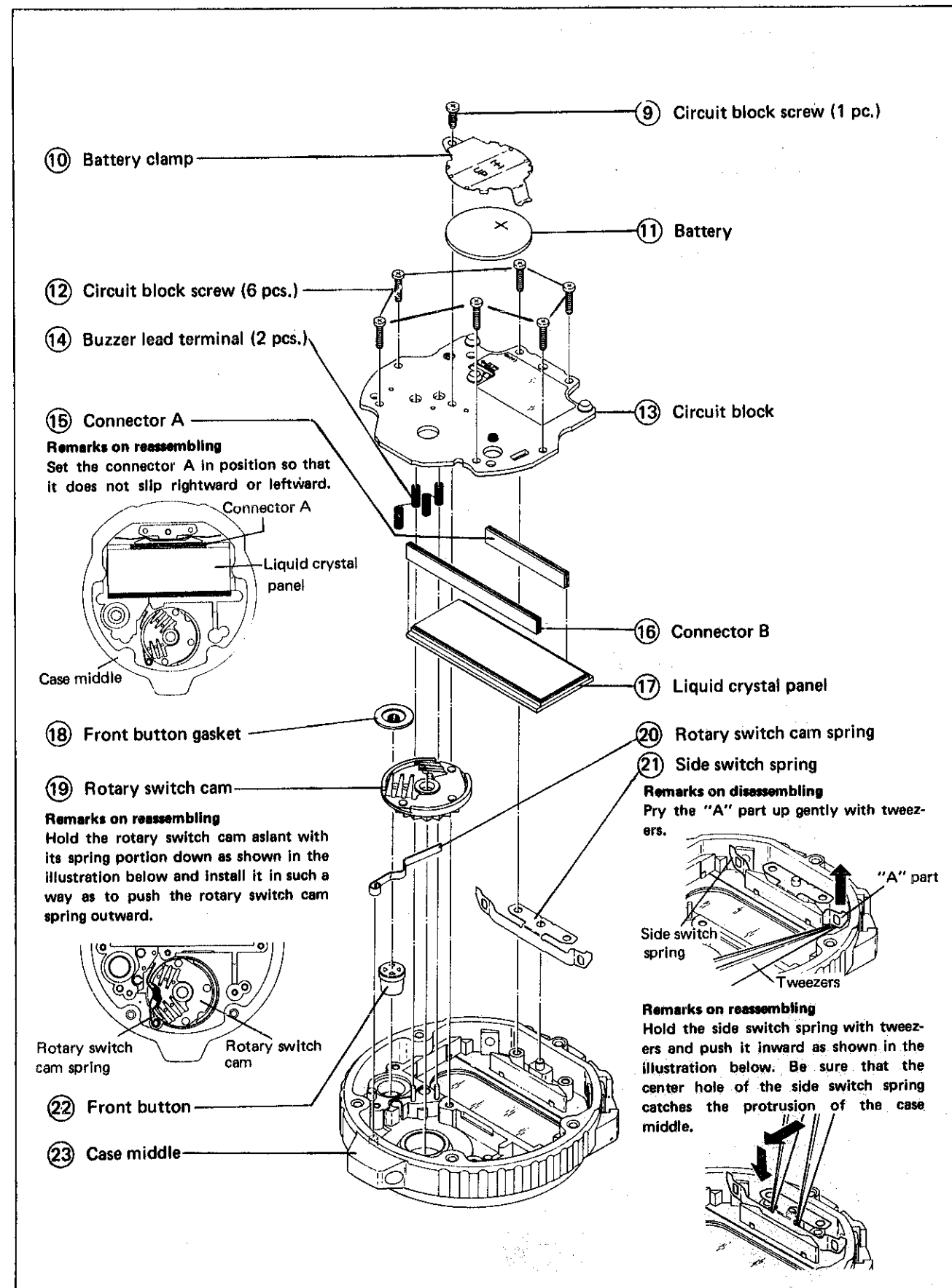

V. RELATIONSHIP BETWEEN THE SEGMENT (LIQUID CRYSTAL PANEL ELECTRODE) AND THE C-MOS-LSI OUTPUT TERMINAL

● Designation of the segment

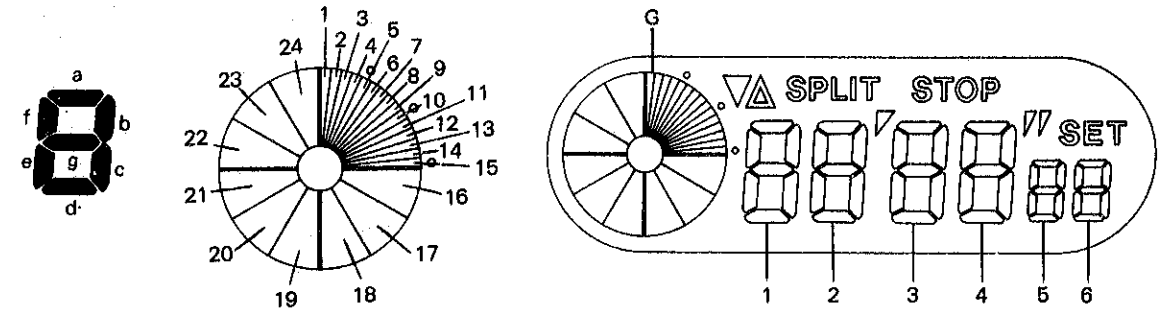

● Relationship between the segment and the C-MOS-LSI output terminal

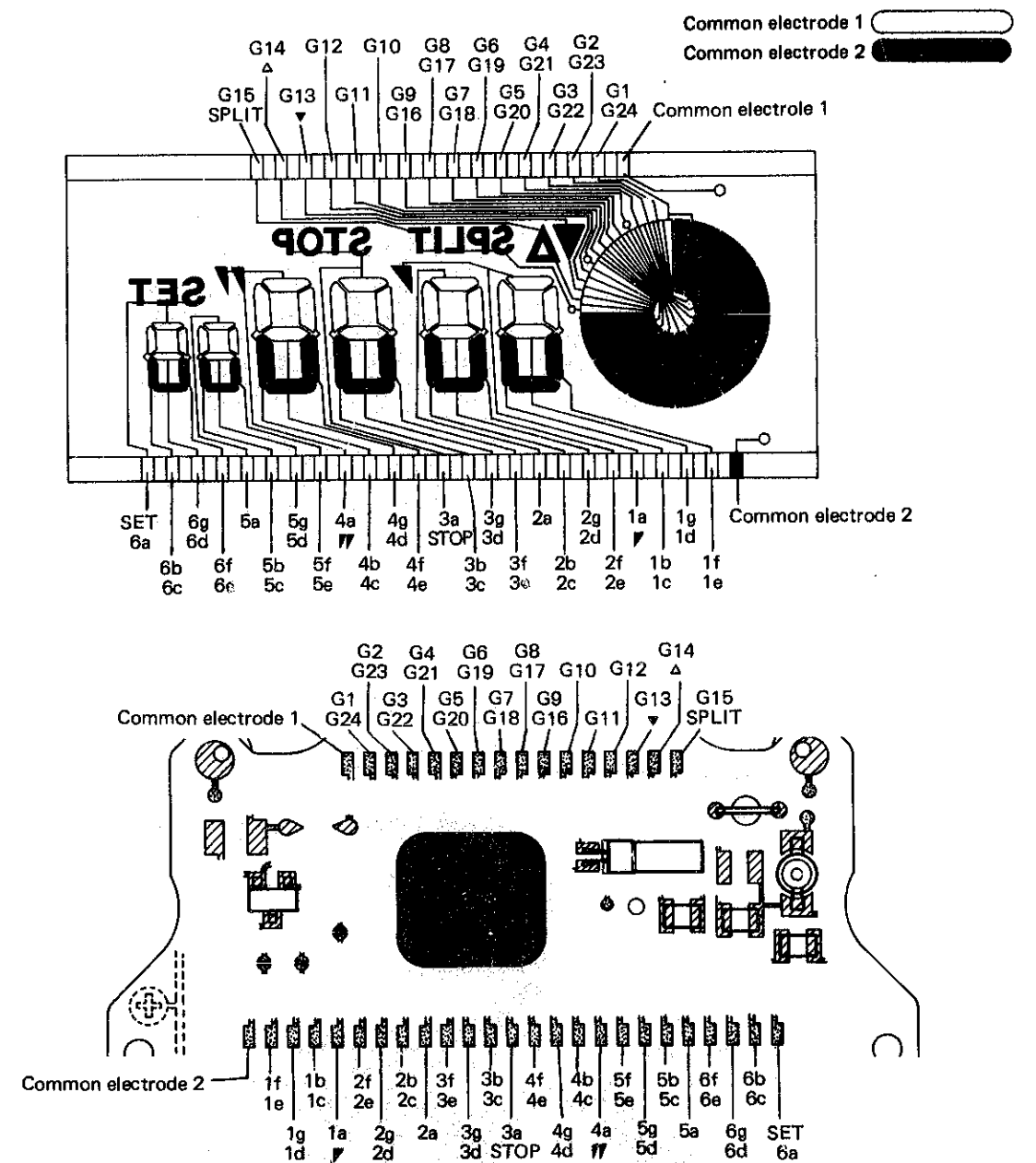

VI. CHECKING AND ADJUSTMENT

- The explanation here is only for the particular points of Cal. S321A.
Refer to the "TECHNICAL GUIDE, GENERAL INSTRUCTION" for SEIKO Digital Quartz for details.

Procedure

• Remarks on replacing the battery

After installing the battery, short-circuit the side switch spring and the all-clear pattern wire with tweezers briefly.

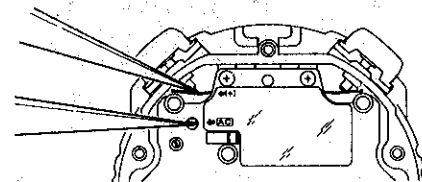

CHECK BATTERY VOLTAGE

Use the Digital Multi-Tester.

Mode to be used: DC V

Result:

[When SEIKO (SEIZAIKEN) CR2016, Sanyo CR2016, or Maxell CR2016 is used]

Normal : More than 2.9V
Defective : Less than 2.9V

[When Matsushita BR2016 is used]

Normal : More than 2.8V
Defective : Less than 2.8V

CHECK CURRENT CONSUMPTION

Use the Digital Multi-Tester.

Mode to be used: μA

1. Current consumption for the whole of the module

- (1) Turn the front button to "STOPW.", and arrange setting as shown in the illustration below.

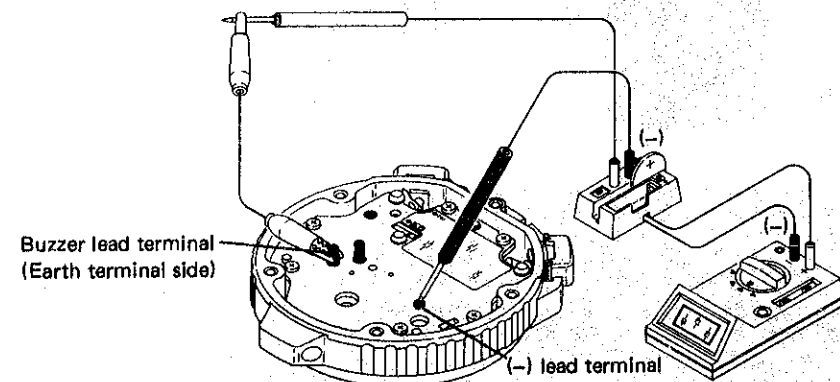

Procedure

- (2) Short-circuit the side switch spring and the all-clear pattern wire with tweezers briefly.

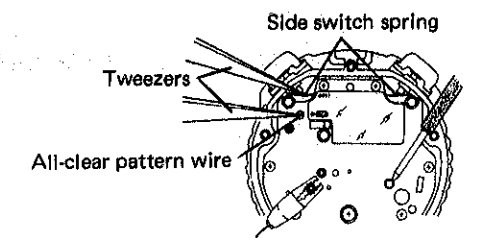

- (3) After approximately 5 seconds, read a value the tester shows.

Result:

Normal : Less than $2.8\mu\text{A}$
Defective : More than $2.8\mu\text{A}$

2. Current consumption for the circuit block alone

- (1) Arrange setting as shown in the illustration below.

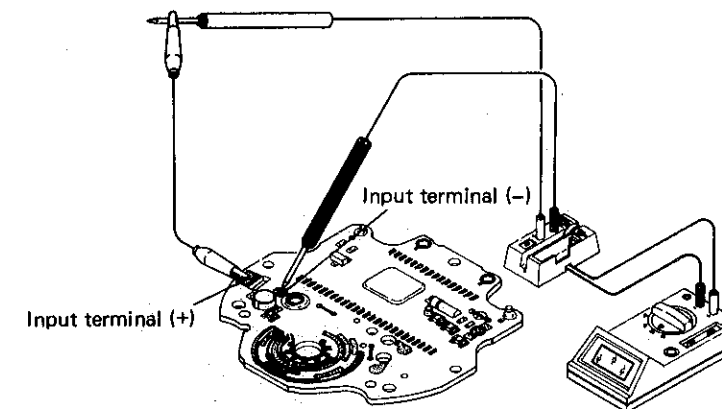

- (2) Short-circuit the "A" part of the circuit block and the all-clear pattern wire with tweezers.

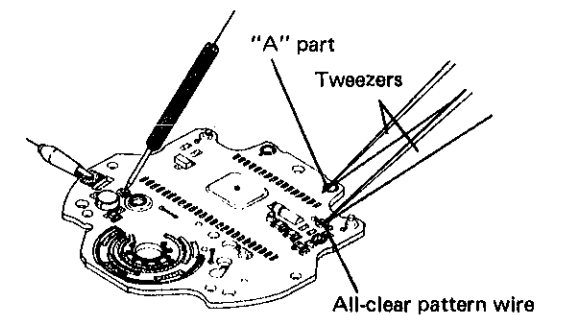

- (3) After approximately 5 seconds, read a value the tester shows.

Result:

Normal : Less than $1.0\mu\text{A}$
Defective : More than $1.0\mu\text{A}$

Procedure

CHECK LIQUID CRYSTAL PANEL AND CIRCUIT BLOCK

Use the Digital Multi-Tester.

Mode to be used: DC V

Check to see if the electric signal is correctly transmitted from the circuit block.

(1) Arrange setting as shown in the illustration below and leave the (-) probe unapplied.

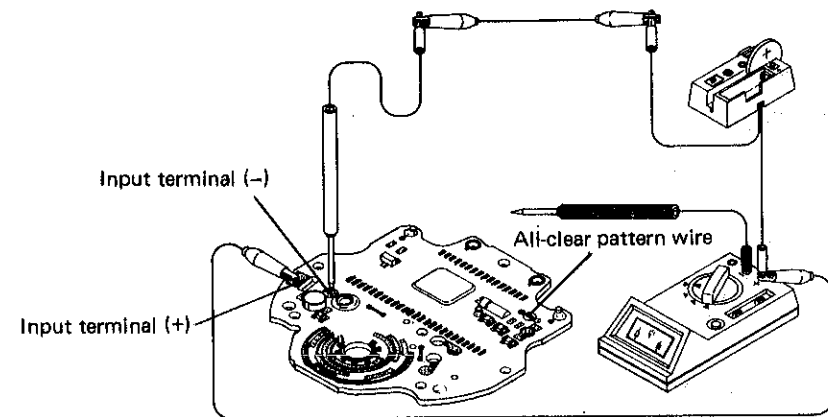

(2) Short-circuit the "A" part of the circuit block and the all-clear pattern wire with tweezers.

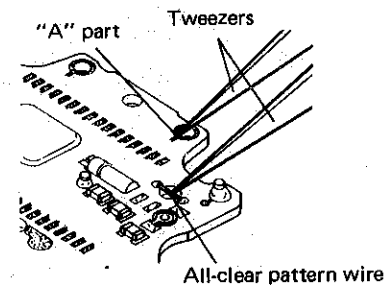

(3) After approximately 5 seconds, apply the (-) probe and read a value the tester shows.

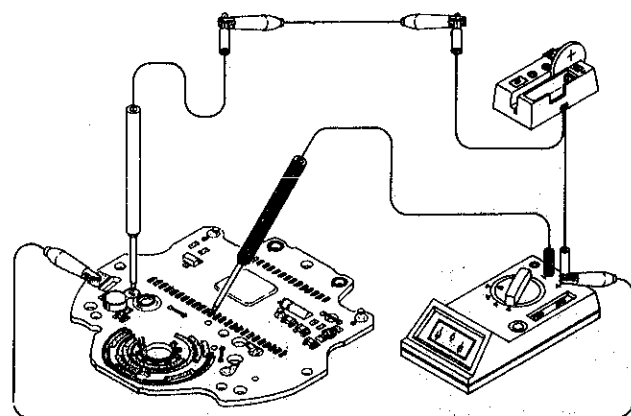

Result:
 Normal : More than 0.8V
 Defective : Less than 0.8V

Procedure

CHECK ALL THE SEGMENTS LIT UP

Short-circuit the side switch spring and the all-clear pattern wire with tweezers briefly. All the segments will light up only for approximately 2 seconds.

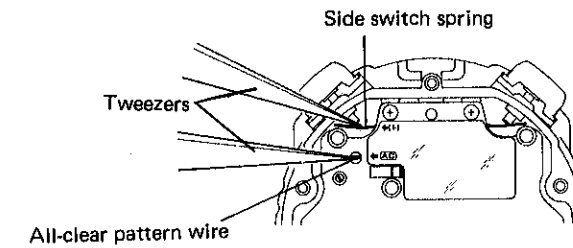

CHECK ALARM CONDITION

1. Check to see if there is any contamination on the contact of the piezoelectric element and on that of the buzzer lead terminal. Also, check to see if there is any deformation on the buzzer lead terminal.
2. Measure the resistance for the upconverter coil of the circuit block and check it for broken wire and short circuit.

Use the Digital Multi-Tester.

Mode to be used: Ω

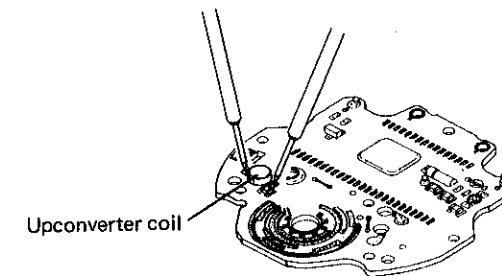

Result:
 Normal : $50\Omega \sim 70\Omega$
 Defective — Less than 50Ω
 More than 70Ω

All procedures of Disassembling, Reassembling, Lubricating, Checking and Adjustment are completed.