

# TECHNICAL GUIDE

CAL. Y765A

## DIGITAL QUARTZ

### CONTENTS

I. SPECIFICATIONS.....	2
II. DISPLAY FUNCTION .....	3
III. DISASSEMBLING, REASSEMBLING AND LUBRICATING.....	4
1. Disassembling and reassembling of the module.....	4
2. Disassembling, reassembling and lubricating of the case.....	5
3. Cleaning .....	6
IV. RELATIONSHIP BETWEEN THE SEGMENTS (LIQUID CRYSTAL PANEL ELECTRODES) AND C-MOS-LSI OUTPUT TERMINALS .....	7
V. CHECKING AND ADJUSTMENT .....	9
1. Guide table for checking and adjustment .....	9
2. Circuit block schematic.....	10
3. Procedure for checking and adjustment.....	10
A. Check battery voltage .....	10
B. Check battery conductivity .....	10
C. Check current consumption .....	11
D. Check water resistance .....	12
E. Check contact between C-MOS-LSI and liquid crystal panel.....	12
F. Check liquid crystal panel and circuit block.....	12
G. Check accuracy.....	13
H. Check functioning and adjustment .....	13
I. Check conductivity of switch component .....	13
J. Check bulb condition .....	14
K. Check alarm function .....	14

# FOREWARD

## SYSTEM RESET WHEN REPLACING BATTERY

Because of the characteristics of the IC used in Cal. Y765, the following procedures are required when the battery is replaced. When replacing the battery, always proceed as follows.

### [Loading battery/installing module]

When the battery is replaced, the liquid crystal panel shows abnormal indications or no indication. When replacing the battery, carry out the system reset as follows.

#### < Procedure >

After installing the battery, short-circuit the printed circuit patterns (→ and ←) shown in the right figure with tweezers (conductive) and depress one of A, B and C buttons. With the above two procedures, the system reset is performed. (Always carry out the procedures in the specified order.)

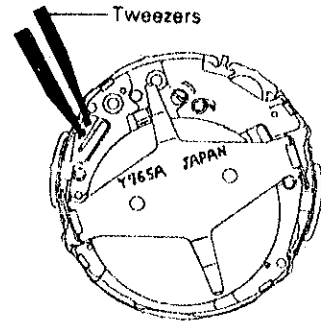

### [Measuring current consumption]

To measure the current consumption, the system reset should be carried out. For details, refer to "Checking and adjustment" on page 11.

The mark seal indicating the above procedures is stuck onto the case back.

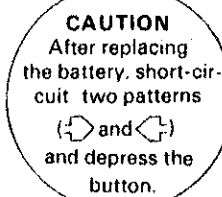

## I. SPECIFICATIONS

Item	Cal. No.	Y765A
Display medium		Nematic Liquid Crystal, FEM (Field Effect Mode)
Display system		<ul style="list-style-type: none"> <li>● Time display</li> <li>● Alarm display</li> <li>● Stopwatch display</li> <li>● Game display (invader game and football game)</li> <li>● Time setting function</li> </ul>
Additional mechanism		<ul style="list-style-type: none"> <li>● Pattern segment checking system</li> <li>● Illuminating light</li> <li>● System reset function</li> <li>● Alarm test system</li> </ul>
Loss/gain		Loss/gain at normal temperature range. Monthly rate: Less than 15 seconds
Casing diameter		φ28.1 mm
Height		5.8 mm
Liquid crystal panel drive system		Multiplex driving
Regulation system		Trimmer condenser
Measuring gate		Any gate is available

Item	Cal. No.	Y765A
Battery		Lithium battery: Matsushita BR2016    Maxell CR2016
		Voltage: 3.0V
		Life: Approx. 3 years

## II. DISPLAY FUNCTION

### < Time mode >

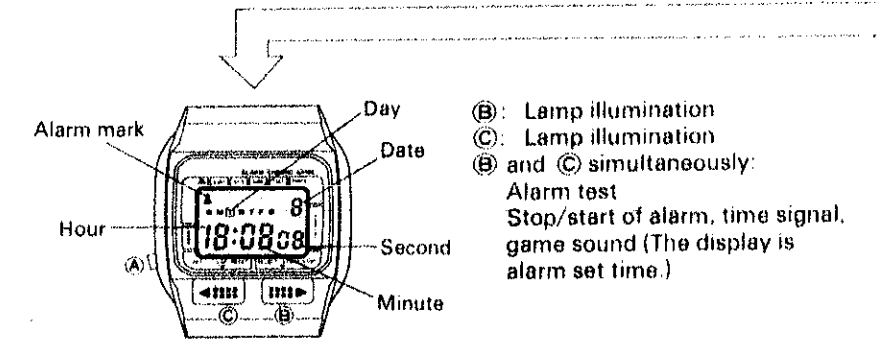

### < Alarm time setting mode >

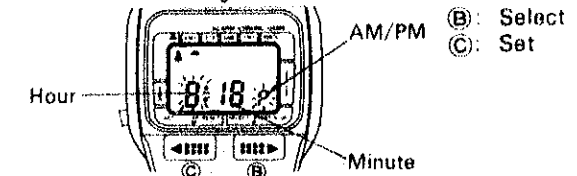

### < Stopwatch mode >

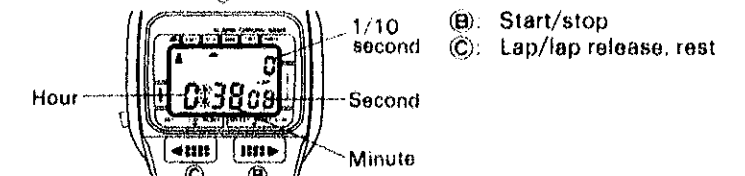

### < Game mode >

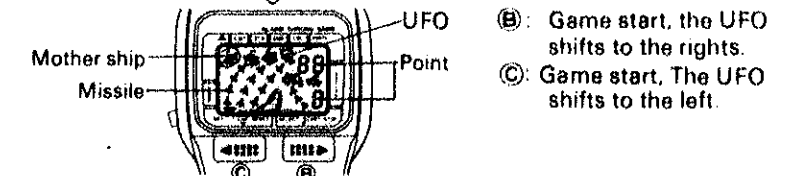

### < Time setting mode >

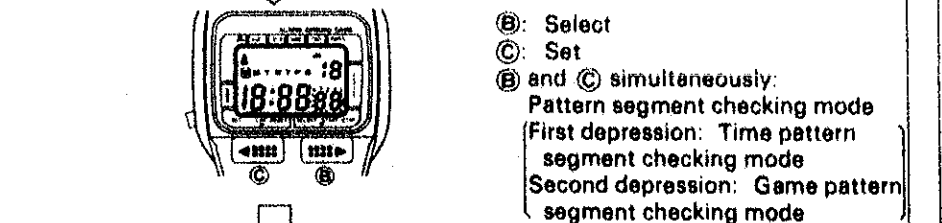

### III. DISASSEMBLING, REASSEMBLING AND LUBRICATING

#### 1. Disassembling and reassembling of the module

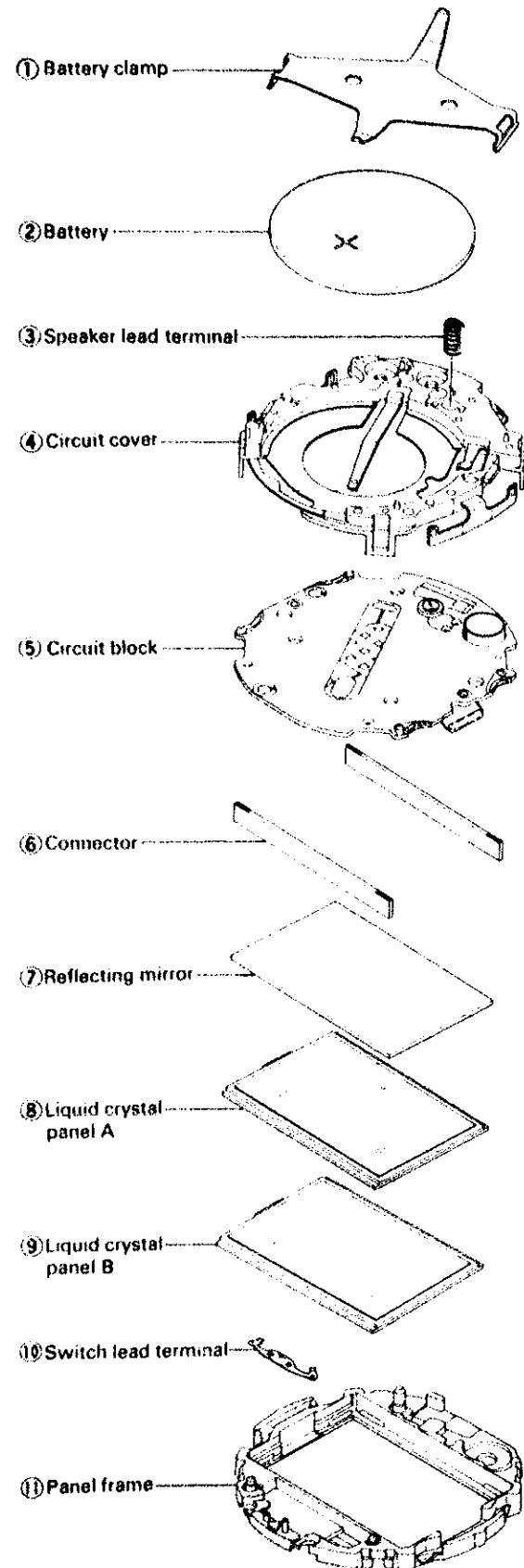

**NOTE:**

As shown in the illustration below, the panel frame and circuit cover are engaged with the plastic parts. When disassembling or reassembling, take care not to apply excessive force with tweezers. (Lightly pry out the green hook of the circuit cover with tweezers.)

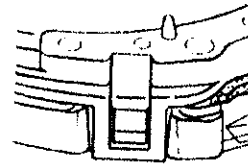

**NOTE:**

Two connectors, A and B, are supplied. Put in position the longer one on 6H side.

**NOTE:**

Two liquid crystal panels A and B are used. The liquid crystal panel A is time segment and B is game segment. When installing the panels, pay attention to their orders.

**NOTE:**

Identification of 6H and 12H direction  
When the panel frame is viewed from the direction in which the circuit block is inserted, the side in which the circular hole is provided is 12H side and the side in which the square hole is provided is 6H side. Install the panel frame in the correct direction.

#### 2. Disassembling, reassembling and lubricating of the case

- A new construction of the front button is employed in Cal. Y765. A button return gasket is used in the front button to ensure button return and stable operation. The front button is retained with button fixing ring or only by pressing down button from outside without using the button fixing ring. (The constructions of the case back, side button and glass are the same as those employed in the former digital watch.)

[Cross-sectional view of the front button retained with button retaining ring]

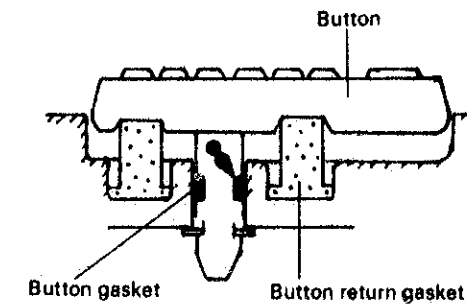

Lubricant

● Silicone grease (500,000 c.s.)

[Cross-sectional view of the front button using the button pressing down system]

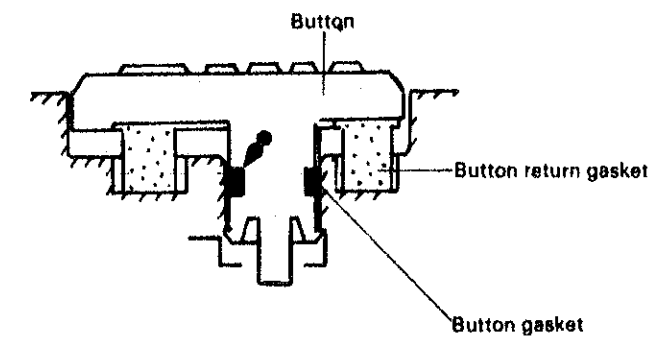

**NOTE:** In the normal servicing, it is not necessary to remove the buttons.

### 3. Cleaning

Name of parts	Cleaning	Drying	Solution	Remarks
Connector	Rinse or wash with a soft brush	Warm air	Alcohol	<ul style="list-style-type: none"> <li>Clean the contacting portion between the connector and liquid crystal panel and circuit block.</li> <li>Never use benzene, or trichloroethylene as these will dissolve the parts.</li> <li>Do not set the connector until it is completely dry.</li> </ul>
Plastic parts <ul style="list-style-type: none"> <li>Panel frame</li> </ul>	Rinse or wash with a soft brush	Warm air	Alcohol or benzene	
<ul style="list-style-type: none"> <li>Circuit cover</li> </ul>				
Metal parts <ul style="list-style-type: none"> <li>Battery clamp</li> </ul>	Rinse or wash with a cleaner or wash with a soft brush.	Warm or hot air	Alcohol, benzene or trichloroethylene	

★ Parts that must not be cleaned.



Circuit block



Liquid crystal panel



Reflecting mirror



Battery

- Only the conductive portions should be wiped with a cloth moistened with benzene and dried with warm air.
- Remove dust and lint with a brush.
- Be careful not to scratch the front surface of the reflecting mirror.

## IV. RELATIONSHIP BETWEEN THE SEGMENTS (LIQUID CRYSTAL PANEL ELECTRODES) AND C-MOS-LSI OUTPUT TERMINALS

### NOTE:

- Two different games are available in Cal Y785A. One is an invader game and the other is a football game. The component parts which are used in the two different game watches are the same except for game liquid crystal panel. Please note that the output segments of the game liquid crystal panels slightly differ.

### ● Designation of segments

< Time >

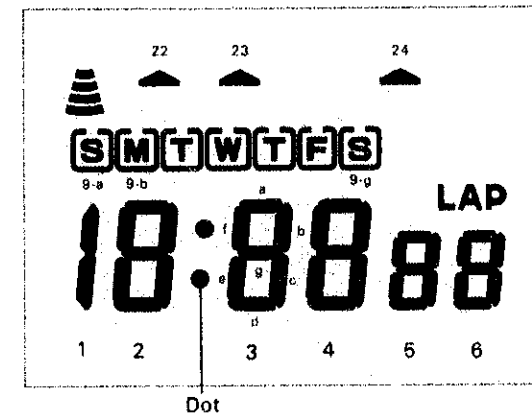

### ● Segment electrodes

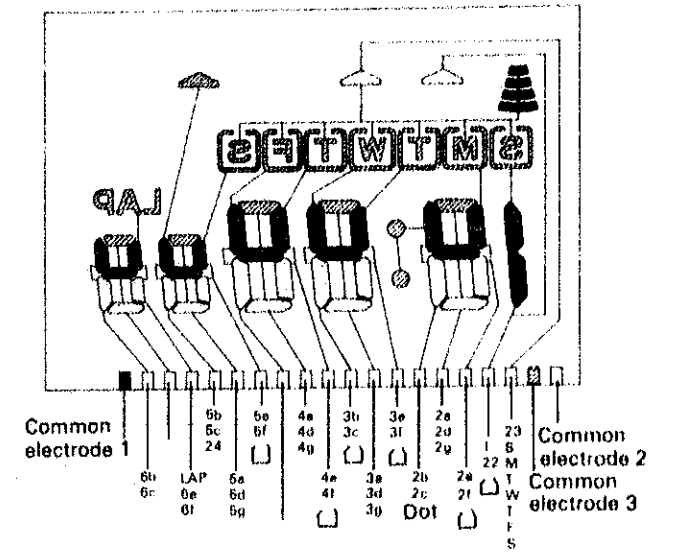

< Invader game >

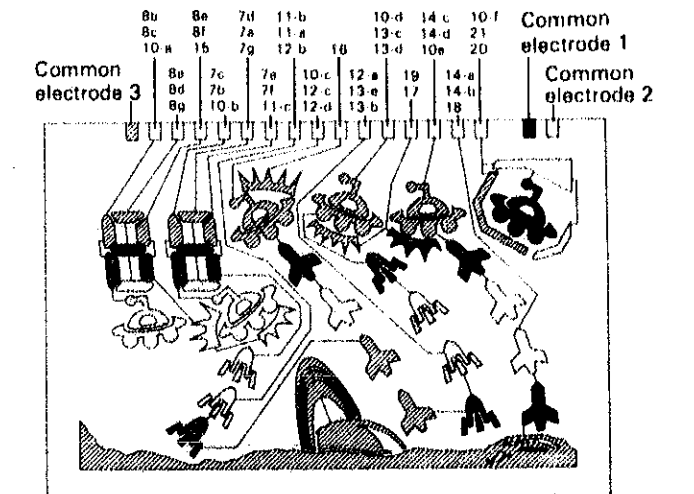
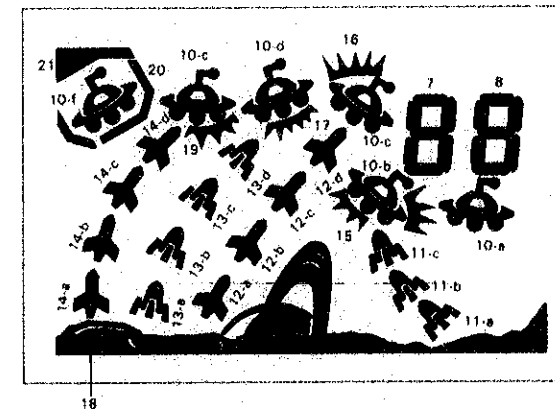

< Football game >

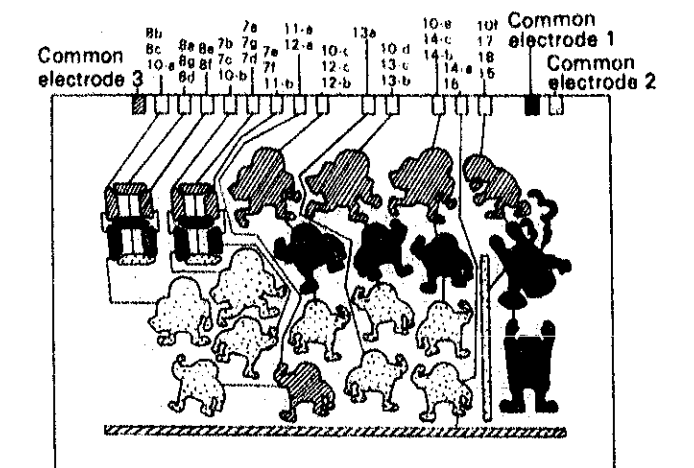
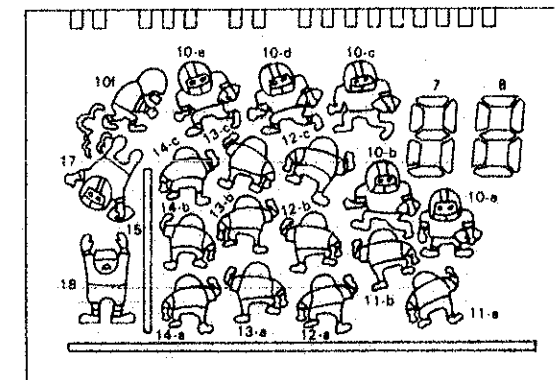

● C-MOS-LSI output terminal

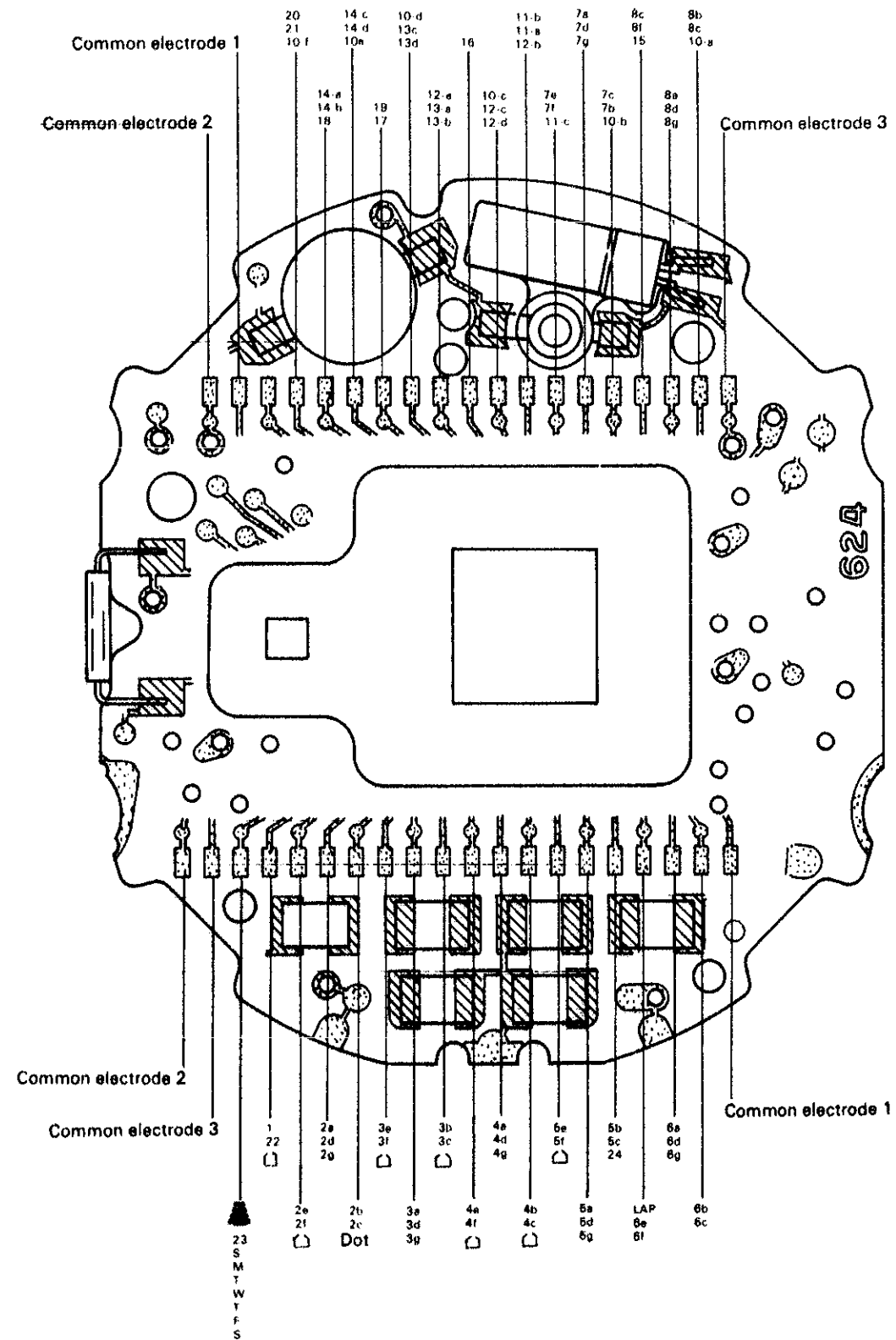

# V. CHECKING AND ADJUSTMENT

## 1. Guide table for checking and adjustment

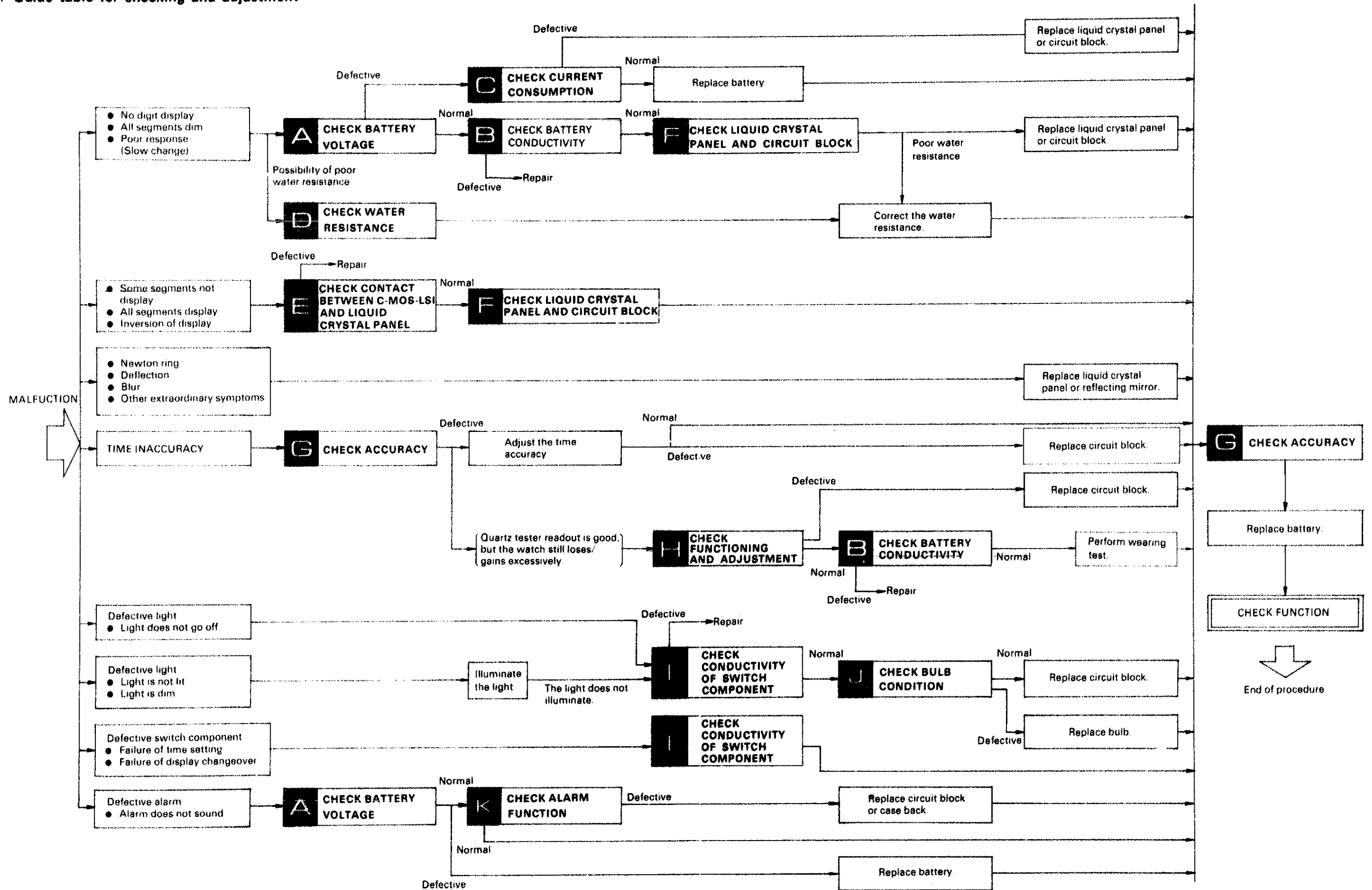

## 2. Circuit block schematic

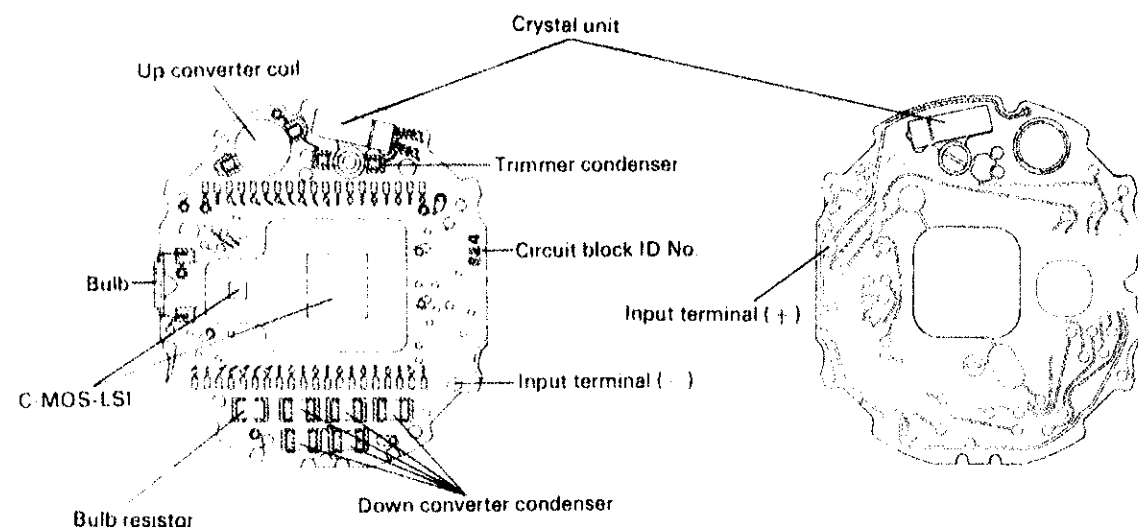

## 3. Procedure for checking and adjustment

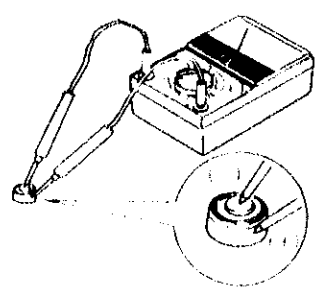
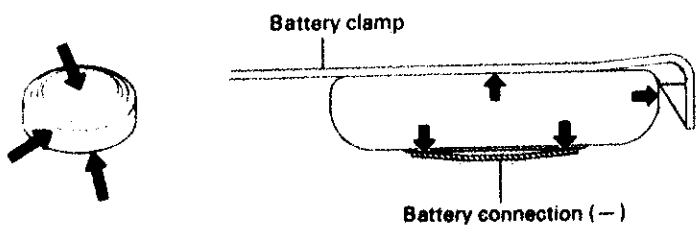
	Procedure	Result and repair
CHECK BATTERY VOLTAGE	 <p><b>NOTE:</b> When the battery surface is protruded, the battery is defective. This is caused from a large current flow. Always replace the battery. (Allowable protrusion: 0.2 ~ 0.3 mm)</p>	<p>More than 2.8V: Normal Less than 2.8V: Defective (Refer to NOTE below.)</p> <p><b>NOTE:</b></p> <ul style="list-style-type: none"> <li>When the light is illuminated, alarm is functioned or battery is short-circuited, the battery voltage temporarily drops. When the battery voltage is 2.6 ~ 2.8V, leave the battery for a few minutes. If the battery voltage is still less than 2.8V, replace the battery.</li> <li>If no digit is displayed with the light illuminated, replace the battery even when the battery voltage is more than 2.8V.</li> </ul>
CHECK BATTERY CONDUCTIVITY	<p>Check the battery, battery clamp and battery connection (-) for contamination.</p> 	<p>Untampered: Normal Proceed to <b>1</b>.</p> <p>Contaminated: Defective Clean</p> <p>Poor water resistance is found: Correct water resistance.</p>

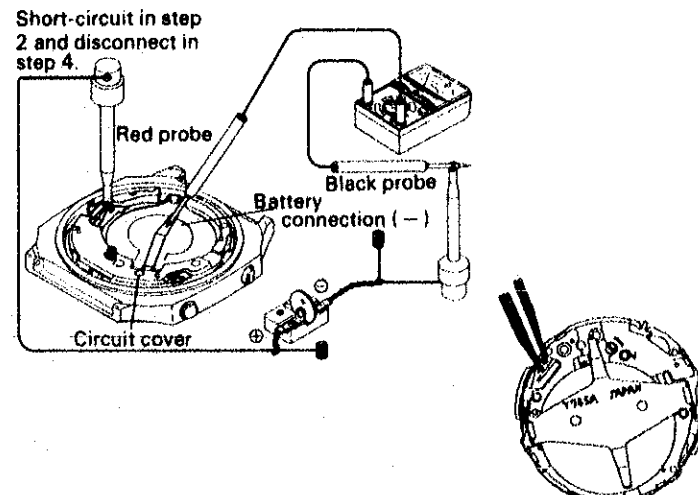
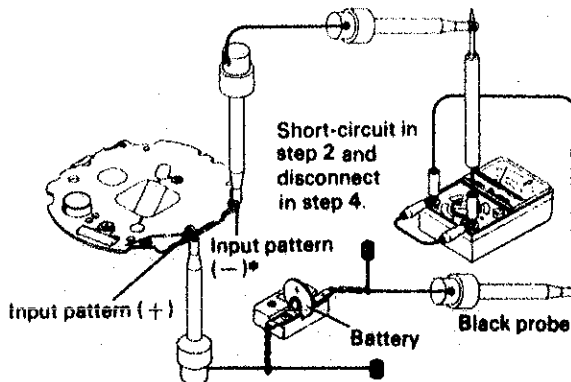
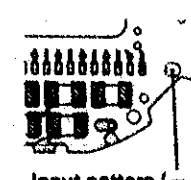
	Procedure	Result and repair
CHECK CURRENT CONSUMPTION	<p>(1) Total current consumption of module</p> <ul style="list-style-type: none"> <li>Measure the current consumption as shown below.</li> </ul> <p>Step 1. Connect the power supply and Volt-ohm-meter as illustrated below.</p> <p>Step 2. Short-circuit the (+) and (-) terminals of the Volt-ohm-meter.</p> <p>Step 3. Short-circuit the circuit block patterns (◆, ◆) with tweezers and depress one of A, B and C buttons.</p> <p>Step 4. Disconnect the (+) and (-) terminals of the Volt-ohm-meter.</p> <p>The current consumption of the module is now measured.</p>  <p>(2) Current consumption of circuit block</p> <ul style="list-style-type: none"> <li>Measure the current consumption of circuit block in the same manner in measuring current consumption of module.</li> </ul> <p>Step 1. Connect the power supply and Volt-ohm-meter as illustrated below.</p> <p>Step 2. Short-circuit the (+) and (-) terminals of the Volt-ohm-meter.</p> <p>Step 3. Short-circuit the circuit block pattern (◆, ◆) with tweezers and depress one of A, B and C buttons.</p> <p>Step 4. Disconnect the (+) and (-) terminals of the Volt-ohm-meter. The current consumption of the circuit block is now measured.</p>  <p>* The input pattern (-) is placed in the top surface of the circuit block. When clamping with the alligator clip, take care not to make the clip into contact with the switch pattern at the bottom.</p> 	<p>Less than 3.0μA: Normal More than 3.0μA: Defective Proceed to <b>2</b>.</p> <p>Less than 2.0μA: Normal More than 2.0μA: Defective Replace the circuit block.</p>

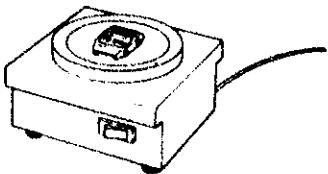
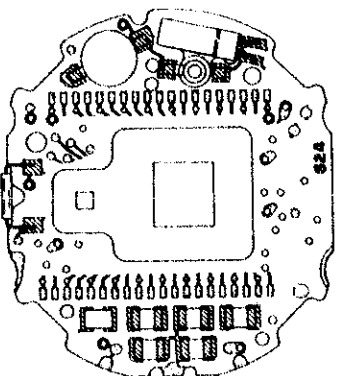
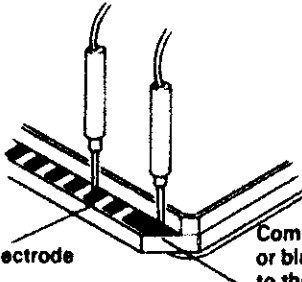

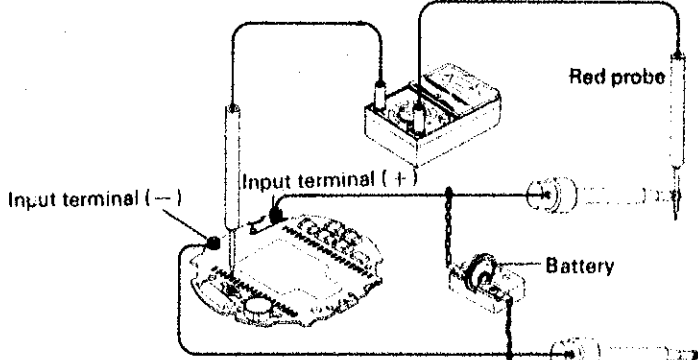
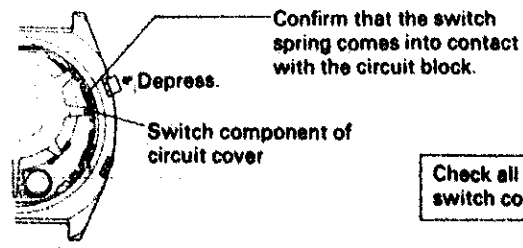
	Procedure	Result and repair
CHECK WATER RESISTANCE	<p>Check for moisture in the watch.</p> <p>① Place the watch on a hot plate and heat it for 15 minutes.</p>  <p>② Check that the glass does not collect moisture.</p>	<p>Does not collect moisture: Normal Proceed to <b>A</b>.</p> <p>Collects moisture: Defective Correct the water resistance. Refer to the Watch Case Servicing Guide.</p>
CHECK CONTACT BETWEEN C-MOS-LSI AND LIQUID CRYSTAL PANEL	<p>(1) Check for dust, lint and contamination on the liquid crystal panel electrodes and connectors and also for flaws, cracks and defects on the liquid crystal panels and connectors.</p> 	<p>Uncontaminated: Normal Proceed to <b>B</b>.</p> <p>Contaminated: Defective Remove any foreign matter.</p>
CHECK LIQUID CRYSTAL PANEL AND CIRCUIT BLOCK	<p>● Check that the liquid crystal panels and circuit block function correctly. Refer to "Relationship between the segments (liquid crystal panel electrodes) and C-MOS-LSI output terminals on page 7."</p> <p>(1) Checking the liquid crystal panels.</p> <p>① Set up the Volt-ohm-meter. Range to be used: OHMS <math>R \times 1 - R \times 1k</math></p> <div style="border: 1px solid black; padding: 5px;"> <p><b>NOTE:</b> Any range will do if more than 3V is applied to the terminals of the Volt-ohm-meter. In some Volt-ohm-meter, a voltage of more than 3V cannot be applied to the terminal. In this case, all segments are not displayed. Use a higher resistance range (<math>R \times 10k</math>).</p> </div> <p>② Remove the liquid crystal panels from the module and turn them to the reverse sides.</p> <p>③ Check that the corresponding segment is displayed.</p>  <div style="border: 1px solid black; padding: 5px;"> <p><b>NOTE:</b> Either red or black probe will do.</p> </div>	<p>Displayed: Normal Proceed to <b>B</b> (2).</p> <p>Not displayed: Defective Replace the defective liquid crystal panel.</p>

	Procedure	Result and repair
CHECK LIQUID CRYSTAL PANEL AND CIRCUIT BLOCK	<p>(2) Checking the circuit block output</p> <p>① Set up the volt-ohm-meter. Range to be used: DC3V</p> <p>② Set up the circuit block. 1) Disassemble the module and remove the circuit block.</p> <p>(3) Connect the power supply and Volt-ohm-meter as illustrated below and carry out the system reset as described in "C. CHECK CURRENT CONSUMPTION" on page 11 before checking.</p>  <p>(3) Checking Red probe: Circuit block (+) terminal Black probe: C-MOS-LSI output terminal (If a segment is defective, connect the black probe to the corresponding electrode.)</p>	<p>More than 0.8V: Normal (The voltage at all terminals should be more than 0.8V.) Return to <b>B</b>.</p> <p>Less than 0.8V: Defective Replace the circuit block.</p>
CHECK ACCURACY	<p>(1) Set the watch to the pattern segment mode. (Either pattern segment mode of two panels will do.)</p> <p>(2) Any measuring gate can be used.</p> <p>(3) Adjust the level.</p> <p>(4) Measure the accuracy.</p>	<p>Does not lose/gain: Normal Loses/gains: Defective Adjust with the trimmer condenser. If the time accuracy cannot be adjusted with the trimmer condenser, replace the circuit block.</p>
CHECK FUNCTIONING AND ADJUSTMENT	<p>Check the functioning and adjustment referring to "Display function" on page 3.</p> <p>① Check that the time mode and calendar mode are changed correctly.</p> <p>② Carry out the alarm test and check that the alarm sounds and alarm mark is displayed correctly.</p> <p>③ Check the functioning for each digit in the time and calendar modes and confirm that the digit is advanced correctly.</p>	<p>Functions correctly and can be adjusted: Normal Wear the watch on the wrist to check time accuracy. Does not function correctly and cannot be adjusted: Defective Replace the circuit block</p>
CHECK CONDUCTIVITY OF SWITCH COMPONENT	<p>(1) Check that the switch spring functions correctly.</p>  <div style="border: 1px solid black; padding: 5px;"> <p>Check all four switch components.</p> </div> <p>(2) Check for dust, lint and other contamination of the connecting portions.</p>	<p>Functions correctly: Normal Do not function correctly: Defective Correct the switch spring with tweezers, or replace the circuit cover. Uncontaminated: Normal Contaminated: Defective Wipe off any foreign matter.</p>

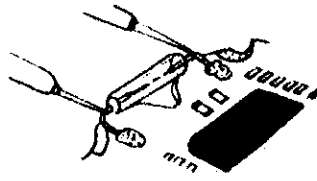

# PARTS LIST

# CAL. Y765A

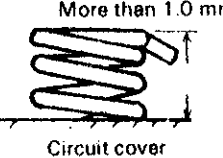
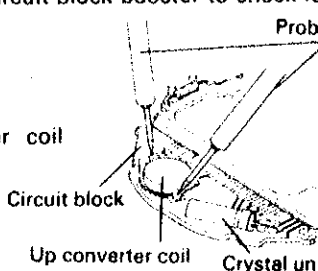
	Procedure	Result and repair
CHECK BULB CONDITION	<p>Check that the filament is not broken.</p> <p>① Set up the Volt-ohm-meter. Range to be used: OHMS R × 1</p> <p>② Checking Apply two probes of the Volt-ohm-meter to the bulb leads as shown in the illustration</p>  <div style="border: 1px solid black; padding: 5px; width: fit-content; margin-left: 200px;"> <p><b>NOTE:</b> Either red or black probes will do.</p> </div>	<p>Bulb lights up: Normal</p> <p>Bulb does not light up: Defective</p> <p>Replace the bulb.</p>
CHECK ALARM FUNCTION	<p>(1) Check the contacting portion of the piezo electric element on the case back and speaker lead terminal for contamination and check the speaker lead terminal for deformation.</p>  <p style="text-align: center;">Piezo electric element</p> <p><b>NOTE:</b> The distance between the circuit cover and top of speaker lead terminal should be more than 1.0 mm. Measure the distance with the speaker lead terminal fully inserted.</p>  <p style="text-align: center;">More than 1.0 mm Circuit cover</p> <p>(2) Measure the coil resistance of the circuit block booster to check for a short-circuit and a broken wire Range to be used: OHMS R × 1</p> <ul style="list-style-type: none"> <li>● <b>Checking</b> Attach the probes to the booster coil terminals. Either red or black probe will do.</li> </ul> 	<p>Uncontaminated: Normal</p> <p>Contaminated: Defective Wipe off any foreign matter.</p> <p>Deformed: Defective Correct with tweezers.</p> <p>50Ω — 90Ω: Normal</p> <p>Less than 50Ω: Defective (Short-circuit)</p> <p>More than 90Ω: Defective (Broken wire) Replace the circuit block.</p>
HOW TO CHECK FOR BATTERY ELECTROLYTE LEAKAGE AND REPAIR	<p>(1) Remove the module from the case.</p> <p>(2) Disassemble the module.</p> <p>(3) Wipe off any electrolyte from the circuit block.</p> <p>① Wipe off the electrolyte with cloth moistened with alcohol. (Pay particular attention to the connecting portion.)</p> <p>② Dry with warm air by using a dryer.</p> <div style="border: 1px solid black; padding: 5px; margin: 10px 0;"> <p><b>NOTE:</b></p> <ul style="list-style-type: none"> <li>● If the electrolyte leakage is excessive, replace the circuit block.</li> <li>● Use a lint-free cloth.</li> </ul> </div> <p>(4) Clean other parts (circuit cover, panel frame) which have become contaminated with the electrolyte.</p> <p>① Wipe off battery electrolyte on the other parts with a soft brush moistened with alcohol.</p> <p>② Dry with warm air by using a dryer.</p> <div style="border: 1px solid black; padding: 5px; margin: 10px 0;"> <p><b>NOTE:</b></p> <ul style="list-style-type: none"> <li>● If a part is damaged, replace it with a new one.</li> </ul> </div> <p>(5) Reassemble the module. Replace the battery with a new one.</p> <p>(6) Check function and current consumption.</p>	

Cal. Y765A	
PART NO.	PART NAME
4001 624	Circuit block
4225 627	Battery clamp
4246 624	Switch lead terminal
4246 795	Buzzer lead terminal
4313 624	Connector B
4313 795	Connector A
4398 624	Liquid crystal panel frame
4410 785	Circuit cover
*4510 745	Liquid crystal panel A
*4510 755	Liquid crystal panel B
*4510 757	Liquid crystal panel B
4521 840	Reflecting mirror
4530 230	Bulb
MAXELL CR2016	Lithium battery
MATSUSHITA BR2016	

**Remarks:**

- ★ Liquid crystal panel
    - 4510 745 (Silver)
    - 4510 755 (Silver)
    - 4510 757 (Gold)
- } Be sure that combination between the color of panel cover and liquid crystal panel should be matched according to the "Casing Parts List".