







- | | | | |
|---|---|-------------|--------------------|
| 1 |  | 2000.725 | Main plate |
| 2 |  | 3909.081 | Setting lever axle |
| 3 |  | 3112.041.CO | Great wheel |



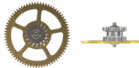
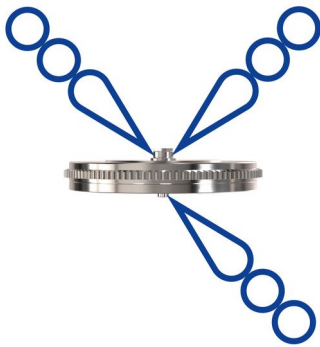

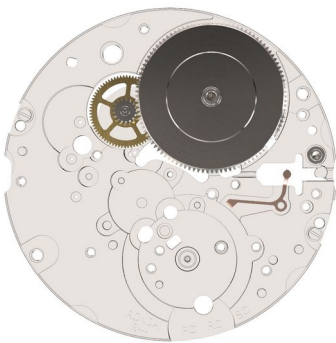



- | | | | |
|---|---|--------|--|
| 4 |  | HP1300 | Moebius HP1300
Oiling the barrel-arbor of the subsequent article. |
|---|---|--------|--|







- | | | | |
|---|---|------------------|------------|
| 5 |  | 3100.054.CO.1140 | Barrel |
| 6 |  | 3016.035 | Stop lever |





- | | | | |
|----|---|----------|----------------|
| 7 |  | 2010.028 | Barrel bridge |
| 8 |  | HP1300 | Moebius HP1300 |
| 9 |  | 4000.357 | Screw |
| 10 |  | 4000.357 | Screw |
| 11 |  | 3500.087 | Click |
| 12 |  | 3905.086 | Click spring |

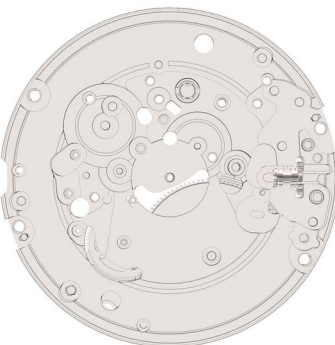

- | | | | |
|----|---|-------------|------------------|
| 13 |  | 3008.030.TA | Crown wheel |
| 14 |  | 2130.237 | Crown wheel core |
| 15 |  | 4000.358 | Screw |
| 16 |  | 4000.358 | Screw |



- | | | | |
|----|---|-------------|----------------|
| 17 |  | 3002.030.FI | Winding pinion |
| 18 |  | 3001.074.FI | Sliding pinion |

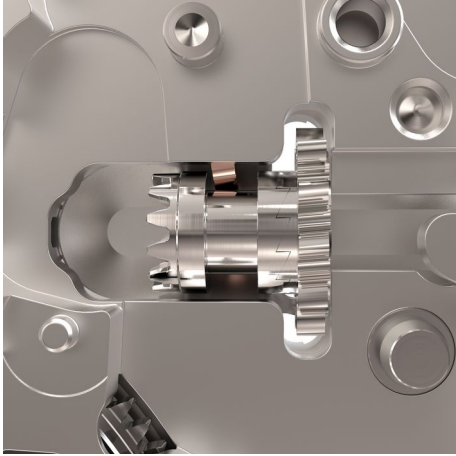

19

Position of stop lever

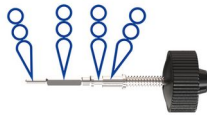

20



HP1300

Moebius HP1300

Oiling before fitting the subsequent article.

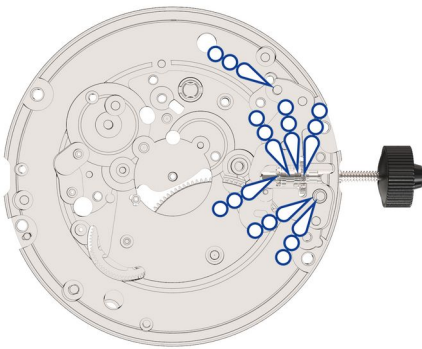

21



3000.214.CO

Working stem



22

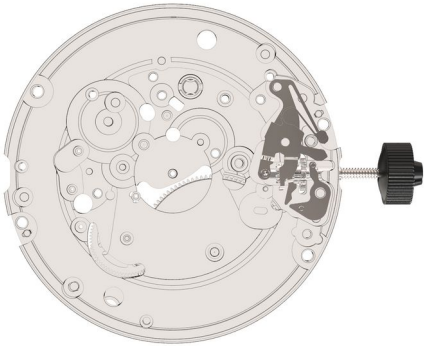

HP1300

Moebius HP1300



- | | | | |
|----|---|-------------|--------------------|
| 23 |  | 3017.066 | Setting lever |
| 24 |  | 3015.101 | Yoke (3 positions) |
| 25 |  | 3015.105.CO | Setting wheel yoke |





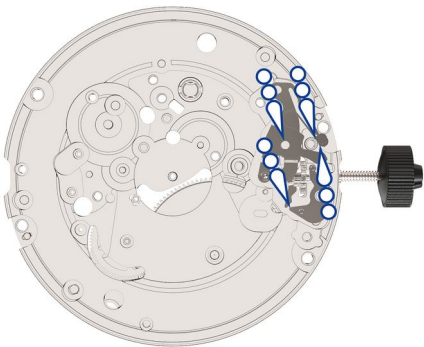

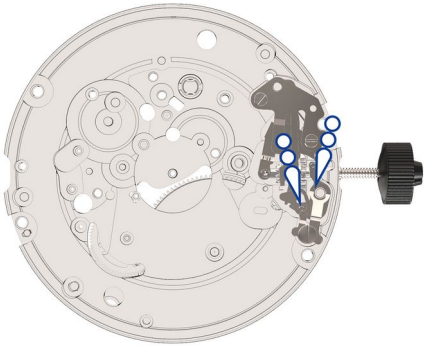

26





- | | | | |
|----|---|--------|----------------|
| 27 |  | HP1300 | Moebius HP1300 |
|----|---|--------|----------------|

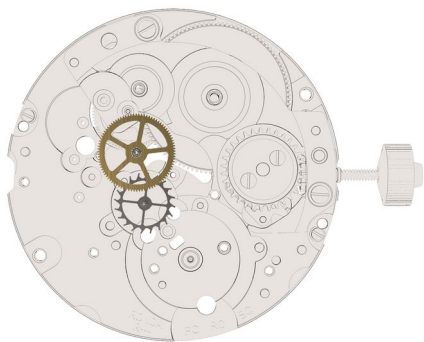

28		3905.092	Setting lever jumper (3 positions)
29		4000.360	Screw
30		4000.360	Screw
31		3905.088	Setting lever spring
32		4000.357	Screw
33		HP1300	Moebius HP1300



34		3240.034.CO	Escape wheel
35		3122.079.CO	Third wheel



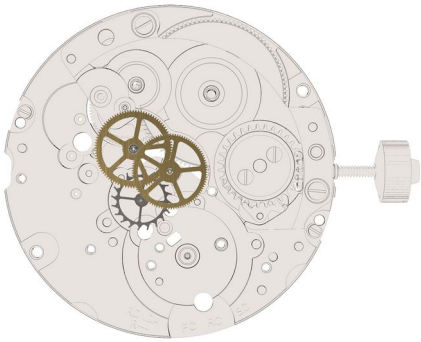

36		9010--9010s	Moebius 9010 / 9010 very small quantity Oiling the second pinion of the subsequent article.
----	---	-------------	--



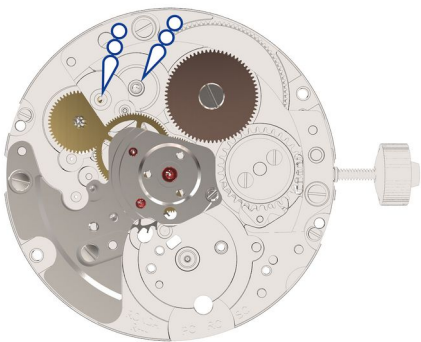

37		3136.222.CO	Second wheel (Aig.)
----	---	-------------	---------------------





38		2020.214	Train wheel bridge
----	---	----------	--------------------

39		4000.357	Screw
----	---	----------	-------

40		4000.357	Screw
----	--	----------	-------

41		4000.362	Screw
----	---	----------	-------





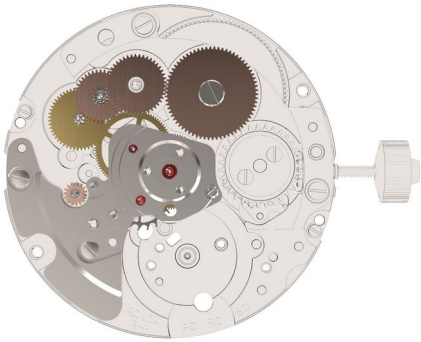

42		3011.048.TA	Ratchet wheel
----	---	-------------	---------------

43		4000.359	Screw
----	---	----------	-------

44		3400.031.CO	Reduction wheel 1
----	---	-------------	-------------------

45		HP1300	Moebius HP1300
----	---	--------	----------------





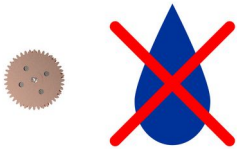

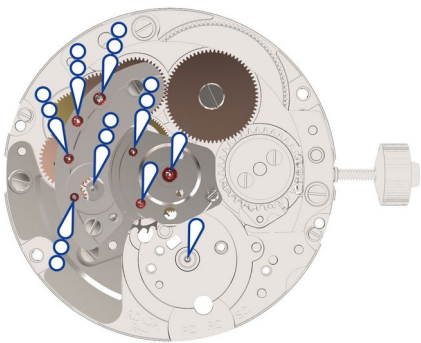

- | | | | | |
|----|---|---|-------------|-----------------------------|
| 46 |  |  | 3400.032.CO | Reduction wheel 2 |
| 47 |  |  | 3004.259.TA | Ratchet winding wheel |
| 48 |  |  | 3004.270.CO | Reverser intermediate wheel |



- | | | | | |
|----|--|--|--|--|
| 49 | Notice:
Washing not recommended for the subsequent article.
Heavily soiled or rusty parts should be replaced by splash lubricated spare parts from Ronda AG. | | | |
|----|--|--|--|--|



- | | | | | |
|----|---|---|--------------|-------------------------------|
| 50 |  |  | 3004.257.CO3 | Reversing wheel |
| 51 |  | | 2110.025 | Automatic device bridge |
| 52 |  | | 4000.358 | Screw |
| 53 |  | | 4000.358 | Screw |
| 54 |  | | HP1300--9010 | Moebius HP1300 / Moebius 9010 |

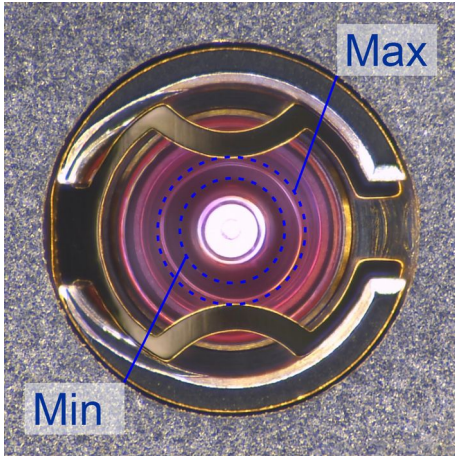

55

Oil quantity in balance shock-absorber

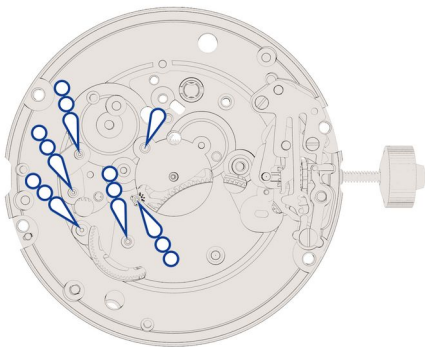

56



HP1300--9010

Moebius HP1300 / Moebius 9010

Caution when cleaning !

Washing in a cleaning solution is not recommended for the following article. As a precaution, clean with Rodico and alcohol.







57

Caution when cleaning !

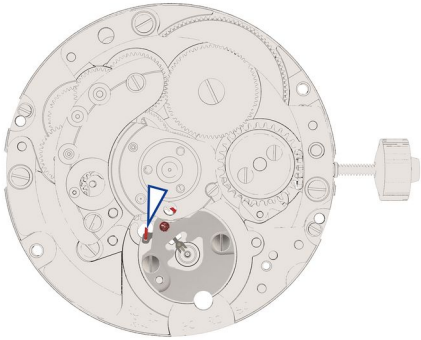
Washing in a cleaning solution is not recommended for the following article. As a precaution, clean with Rodico and alcohol.









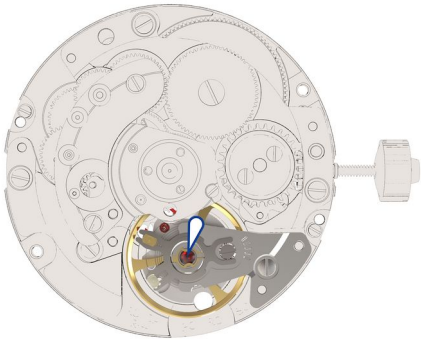

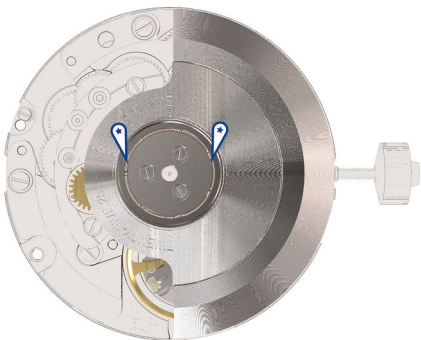

- | | | | |
|----|---|--------------|---------------|
| 58 |  | 3238.007.CO3 | Pallet fork |
| 59 |  | 2040.025 | Pallet bridge |
| 60 |  | 4000.357 | Screw |
| 61 |  | 4000.357 | Screw |

- | | | | |
|----|---|------|--------------|
| 62 |  | 9415 | Moebius 9415 |
|----|---|------|--------------|



- | | | | |
|----|---|--------------|----------------|
| 63 |  | 2050.047.CO4 | Balance bridge |
| 64 |  | 4000.357 | Screw |
| 65 |  | 9010 | Moebius 9010 |





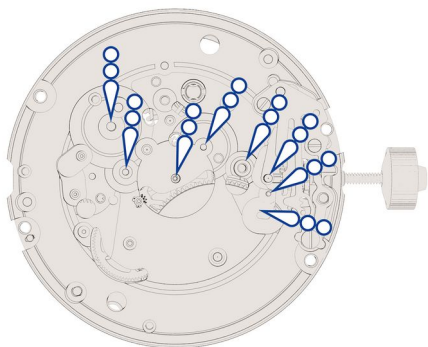



- | | | | |
|----|---|-------------|----------------------------------|
| 66 |  | 3004.250.CO | Oscillating weight wheel |
| 67 |  | 2120.034.CO | Oscillating weight |
| 68 |  | 4000.361 | Screw |
| 69 |  | 4000.361 | Screw |
| 70 |  | 4000.361 | Screw |
| 71 |  | 9010s | Moebius 9010 very small quantity |



- | | | | |
|----|---|--------|----------------|
| 72 |  | HP1300 | Moebius HP1300 |
|----|---|--------|----------------|

- | | | | |
|----|--|--|--|
| 73 | Notice:
Washing not recommended for the subsequent article.
Heavily soiled or rusty parts should be replaced by splash lubricated spare parts from Ronda AG. | | |
|----|--|--|--|



- | | | | |
|----|---|-----------------|--------------------------------------|
| 74 |  | 3305.393.CO | Cannon pinion (Aig.) |
| 75 |  | 3007.093.CO | Minute wheel |
| 76 |  | 3004.262.TA | Intermediate setting wheel |
| 77 |  | 3004.277.TA | Setting wheel |
| 78 |  | 3004.265.TA | Corrector intermediate setting wheel |
| 79 |  | 3507.075.CO | Date corrector |
| 80 |  | 3004.255.CO2 | Date indicator driving wheel |
| 81 |  | 3504.245.AA.1.A | Date indicator (T3, G3) |

82



HP1300

Moebius HP1300

Oiling before fitting the subsequent article.



83



3500.084.CO

Date jumper

84



2130.239

Date indicator maintaining plate

85



4000.360

Screw

86



4000.360

Screw

87



4000.360

Screw

88



HP1300

Moebius HP1300



89



3301.336.TA

Hour wheel (Aig.)

90



3315.003

Friction spring